

LineLazer[®] ES 1000 / ES 2000 Lithium Airless Line Striper

3A9033A
EN

**For the application of line striping materials.
For professional use only.
Not approved for use in explosive atmospheres or hazardous (classified) locations.**

3300 psi (22.8 MPa, 228 bar) Maximum Operating Pressure

See page 4 for model information and approvals.



Important Safety Instructions

Read all warnings and instructions in this manual and in related manuals before using the equipment. Be familiar with the controls and the proper usage of the equipment. Save these instructions.

Related Manuals in English:			
Power Sonic Quick Guide (See QR Code below)			
ES 1000		ES 2000	
311254	Gun	311254	Gun
334599	Pump	310643	Pump
		3A3428	Auto-Layout Application Methods

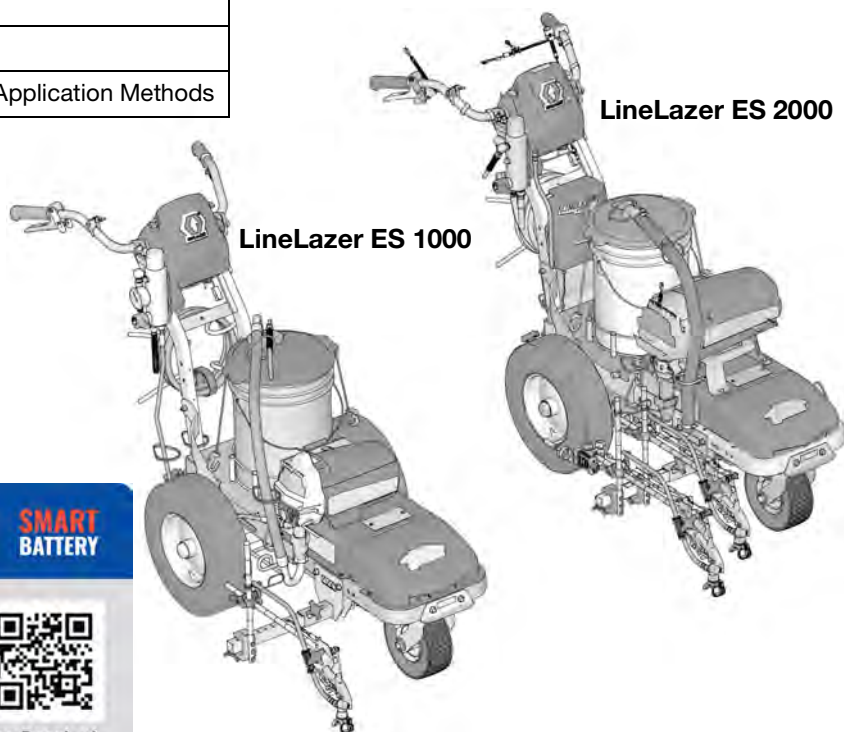

POWER PSONIC
TRUSTED BATTERY SOLUTIONS

SMART BATTERY

LEARN MORE ABOUT THE
LITHIUM BLUETOOTH BATTERY SERIES



Quick Guide



App Download

*Use only genuine Graco replacement parts.
The use of non-Graco replacement parts may void warranty.*



SERVICE
to every customer, every time



www.graco.com/techsupport







Contents

Models	4	LineLazer V LiveLook™ Display	30
Important Grounding Information	5	ES 2000 (Standard Series)	30
Warnings	6	Initial Setup (ES 2000 Standard Series)	31
Component Identification (ES 1000)	10	Striping Mode (ES2000 Standard Series)	33
Component Identification (ES 2000)	11	Measure Mode (ES 2000 Standard Series)	34
Tip Selection	12	Setup/Information	35
Battery and Charger	13	Settings	36
Grounding Procedure to Charge Batteries	14	Information	37
Power Requirements	14	ES2000 (HP Auto Series)	38
Charge the Battery	14	LineLazer V LiveLook Display	39
Grounding Instructions	15	ES2000 (HP Auto Series)	39
Pails	15	Initial Setup (ES2000 HP Auto Series)	40
Pressure Relief Procedure	16	Striping Mode (ES2000 HP Auto Series)	42
Setup	17	Measure Mode (ES2000 HP Auto Series)	43
SwitchTip™ and Guard Assembly	17	Layout Mode	44
Startup	18	Stall Calculator	45
Gun Placement	20	Angle Calculator	46
Install Gun	20	Setup/Information	48
Position Gun	20	Settings	49
Select Manual Guns	20	Information	50
Select Auto Guns (ES 2000)	21	Marker Layout Mode	51
Gun Positions Chart	22	Data Logging	52
Gun Arm Mounts	23	Maintenance	53
Change Gun Position (Front and Back)	23	Recycling and Disposal	54
Change Gun Position (Left and Right)	23	Rechargeable Battery Disposal	54
Installation	24	End of Product Life	54
Trigger Sensor Adjustment (ES 2000)	24	Troubleshooting (ES 1000 & ES 2000)	55
Gun Cable Adjustment	25	Mechanical/Fluid Flow	55
Straight Line Adjustment	26	Electrical (ES 1000)	57
Handle Bar Adjustment	26	ES 2000 Troubleshooting	61
Paint Stripe Width	27	Electrical (ES 2000)	63
Spray Test Stripe	27	Sprayer Will Not Run (ES 1000 & ES 2000)	69
Clearing Tip Clogs	27	Sprayer Will Not Shut Off (ES 1000 & ES 2000)	71
Cleanup	28	Inverter (ES 1000 & ES 2000)	72
Flush Drain Tube	28	Sprayer does not have - 100 VAC for 120V units - 220 VAC for 230V units (ES 1000& ES 2000)	74
Flush Hose and Gun	29	Battery Will Not Charge (ES 1000 & ES 2000)	74
		Parts Drawing - ES 1000	76
		Parts List - ES 1000	77
		Parts Drawing - ES 1000	78
		Parts List - ES 1000	79
		Parts Drawing - ES 1000	80
		Parts List - ES 1000	81
		Parts Drawing - ES 1000	82

Parts List - ES 1000	83	Parts Drawing - ES 2000	98
Swivel Wheel Assembly	83	Parts List - ES 2000	99
Filter	83	Parts Drawing - ES 2000	100
Parts Drawing - ES 1000	84	Parts List - ES 2000	101
Parts List - ES 1000	85	Parts Drawing - ES 2000	102
Gun Holder and Arm.....	85	Parts List - ES 2000	103
Gun Trigger	85	Parts Drawing - ES 2000	104
Parts Drawing - ES 1000	86	Parts List - ES 2000	105
Parts List - ES 1000	87	Swivel Wheel Assembly.....	105
Voltage Meter Box, 120V (ES1000 & ES2000)	88	Parts Drawing - ES 2000	106
Voltage Meter Box, 230V (ES1000 & ES2000)	88	Parts List - ES 2000	107
Parts List	89	Gun Holder and Arm	107
Voltage Meter Box, 120V	89	Gun Trigger	107
Voltage Meter Box, 230V	89	Parts Drawing - ES 2000	108
Control Box, 120V (ES 1000)	90	Parts List - ES 2000	109
Control Box, 230V (ES 1000)	90	Distance Sensor Replacement (ES 2000)	110
Parts List	91	Wiring Diagram - 120V (ES 2000)	111
Control Box, 120V (ES 1000)	91	Control Board Wiring Diagram	112
Control Box, 230V (ES 1000)	91	110/120V (ES 2000).....	112
Wiring Diagram - 120V (ES 1000)	92	230V (ES 2000).....	113
Wiring Diagram - 230V (ES 1000)	93	Wiring Diagram - 230V (ES 2000)	114
Control Board Wiring Diagram	94	World Key Symbol	115
110/120V (ES 1000)	94	Technical Specifications	116
230V (ES 1000).....	95	California Proposition 65	119
Parts Drawing - ES 2000	96	Graco Standard Warranty	120
Parts List - ES 2000	97	Graco Information	120

Models

LineLazer ES 1000 Lithium		
Model	1 Battery Included	2 Batteries Included
25U674	✓ 120V	
25U676		✓ 120V
25U675 CE	✓ 230V	
25U677 CE		✓ 230V

LineLazer ES 2000 Lithium									
Model	2 Batteries Included	Standard Series	HP Auto Series	Number of Manual Guns	Number of Auto Guns	120V	230V	LazerGuide 1700	LazerGuide 2000
25U678	✓	✓		2	0	✓			
25U679	✓		✓	1	1	✓		✓	
25U680	✓		✓	0	2	✓		✓	
25U683	✓		✓	1	1	✓		✓	✓
25U684	✓		✓	0	2	✓		✓	✓
25U681 CE	✓	✓		1	0		✓		
25U682 CE	✓		✓	0	1		✓		
25U685 CE	✓	✓		2	0		✓		
25U686 CE	✓		✓	0	2		✓		
25U687 CE	✓		✓	1	1		✓		

Important Grounding Information

The following information is intended to help you understand when to use the grounding wire and clamp provided with your striper. It is required when flushing or cleaning with flammable materials.

Please read the information on the material container label to determine if it is flammable. Ask for a Safety Data Sheet (SDS) from your supplier. The container label and SDS will explain the contents of the material and the specific precautions related to it.

Flushing and clean-up materials generally fit into one of the following **3 basic types**:

Grounding Wire and Clamp Required?	Type of Flushing or Cleaning Material
Yes 	FLAMMABLE: This type of material contains flammable solvents such as xylene, toluene, naphtha, MEK, lacquer thinner, acetone, denatured alcohol, and turpentine. The container label should indicate that this material is FLAMMABLE. Use flammable materials outdoors or in a well-ventilated area with a flow of fresh air. Follow Grounding Instructions , page 15, when using this type of material.
No	OIL-BASED: The container label should indicate that the material is COMBUSTIBLE and can be cleaned up with mineral spirits or non-flammable paint thinner.
No	WATER: The container label of the material being sprayed should indicate that it can be cleaned with soap and water.

NOTE: When using the spray gun by hand, static build up and static shocks can occur. If you cannot position the striper on a grounded surface and connect the grounding wire and clamp to a metal post, try the following to help reduce the risk of static build up:

- Stand on a true grounded surface when spraying, such as grass
- Try wearing a different type of shoes

Warnings

The following warnings are for the setup, use, grounding, maintenance, and repair of this equipment. The exclamation point symbol alerts you to a general warning and the hazard symbols refer to procedure-specific risks. When these symbols appear in the body of this manual or on warning labels, refer back to these Warnings. Product-specific hazard symbols and warnings not covered in this section may appear throughout the body of this manual where applicable.

WARNING



GROUNDING

This product must be grounded. In the event of an electrical short circuit, grounding reduces the risk of electric shock by providing an escape wire for the electric current. This product is equipped with a cord having a grounding wire with an appropriate grounding plug. The plug must be plugged into an outlet that is properly installed and grounded in accordance with all local codes and ordinances.

- Improper installation of the grounding plug is able to result in a risk of electric shock.
- When repair or replacement of the cord or plug is required, do not connect the grounding wire to either flat blade terminal.
- The wire with insulation having an outer surface that is green with or without yellow stripes is the grounding wire.
- Check with a qualified electrician or serviceman when the grounding instructions are not completely understood, or when in doubt as to whether the product is properly grounded.
- Do not modify the plug provided; if it does not fit the outlet, have the proper outlet installed by a qualified electrician.
- This product is for use on a nominal 120V or 230V circuit and has a grounding plug similar to the plugs illustrated in the figure below.

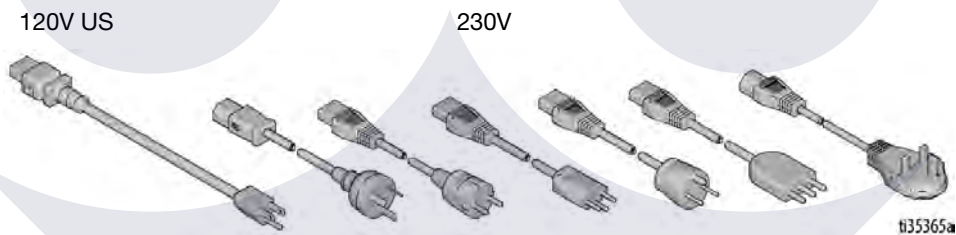

- Only connect the product to an outlet having the same configuration as the plug.
- Do not use an adapter with this product.

Extension Cords:

- Use only a 3-wire extension cord that has a grounding plug and a grounding receptacle that accepts the plug on the product.
- Make sure your extension cord is not damaged. If an extension cord is necessary use 12 AWG (2.5mm²) minimum to carry the current that the product draws.
- An undersized cord results in a drop in line voltage and loss of power and overheating.

WARNING



FIRE AND EXPLOSION HAZARD

Flammable fumes, such as solvent and paint fumes, in work area can ignite or explode. To help prevent fire and explosion:



- Do not spray flammable or combustible materials near an open flame or sources of ignition such as cigarettes, motors, and electrical equipment.
- Paint or solvent flowing through the equipment is able to result in static electricity. Static electricity creates a risk of fire or explosion in the presence of paint or solvent fumes. All parts of the spray system, including the pump, hose assembly, spray gun, and objects in and around the spray area shall be properly grounded to protect against static discharge and sparks. Use Graco conductive or grounded high-pressure airless paint sprayer hoses.
- Verify that all containers and collection systems are grounded to prevent static discharge. Do not use pail liners unless they are antistatic or conductive.
- Connect to a grounded outlet and use grounded extensions cords. Do not use a 3-to-2 adapter.
- Do not spray flammable or combustible liquids in a confined area.
- Sprayer generates sparks. Keep spray area well-ventilated. Keep a good supply of fresh air moving through the area.
- Keep pump assembly in a well ventilated area when spraying, flushing, cleaning, or servicing. Do not spray pump assembly.
- Do not smoke in the spray area or spray where sparks or flame is present.
- Do not operate light switches, engines, or similar spark producing products in the spray area.
- Keep area clean and free of paint or solvent containers, rags, and other flammable materials.
- Know the contents of the paints and solvents being sprayed. Read all Safety Data Sheets (SDSs) and container labels provided with the paints and solvents. Follow the paint and solvents manufacturer's safety instructions.
- Keep a working fire extinguisher in the work area.









SKIN INJECTION HAZARD

High-pressure spray is able to inject toxins into the body and cause serious bodily injury. In the event that injection occurs, **get immediate surgical treatment.**



- Do not aim the gun at, or spray any person or animal.
- Keep hands and other body parts away from the discharge. For example, do not try to stop leaks with any part of the body.
- Always use the nozzle tip guard. Do not spray without nozzle tip guard in place.
- Use Graco nozzle tips.
- Use caution when cleaning and changing nozzle tips. In the case where the nozzle tip clogs while spraying, follow the **Pressure Relief Procedure** for turning off the unit and relieving the pressure before removing the nozzle tip to clean.
- Equipment maintains pressure after power is shut off. Do not leave the equipment energized or under pressure while unattended. Follow the **Pressure Relief Procedure** when the equipment is unattended or not in use, and before servicing, cleaning, or removing parts.
- Check hoses and parts for signs of damage. Replace any damaged hoses or parts.
- This system is capable of producing 3300 psi (22.8 MPa, 228 bar). Use Graco replacement parts or accessories that are rated a minimum of 3300 psi (22.8 MPa, 228 bar).
- Always engage the trigger lock when not spraying. Verify the trigger lock is functioning properly.
- Verify that all connections are secure before operating the unit.
- Know how to stop the unit and bleed pressure quickly. Be thoroughly familiar with the controls.

WARNING

 	<p>EQUIPMENT MISUSE HAZARD Misuse can cause death or serious injury.</p> <ul style="list-style-type: none"> • Do not operate the unit when fatigued or under the influence of drugs or alcohol. • Do not exceed the maximum working pressure or temperature rating of the lowest rated system component. See Technical Data in all equipment manuals. • Use fluids and solvents that are compatible with equipment wetted parts. See Technical Data in all equipment manuals. Read fluid and solvent manufacturer’s warnings. For complete information about your material, request Safety Data Sheet (SDS) from distributor or retailer. • Do not leave the work area while equipment is energized or under pressure. • Turn off all equipment and follow the Pressure Relief Procedure when equipment is not in use. • Check equipment daily. Repair or replace worn or damaged parts immediately with genuine manufacturer’s replacement parts only. • Do not alter or modify equipment. Alterations or modifications may void agency approvals and create safety hazards. • Make sure all equipment is rated and approved for the environment in which you are using it. • Use equipment only for its intended purpose. Call your distributor for information. • Route hoses and cables away from traffic areas, sharp edges, moving parts, and hot surfaces. • Do not kink or over bend hoses or use hoses to pull equipment. • Keep children and animals away from work area. • Comply with all applicable safety regulations.
 	<p>ELECTRIC SHOCK HAZARD This equipment must be grounded. Improper grounding, setup, or usage of the system can cause electric shock.</p> <ul style="list-style-type: none"> • Turn off, disconnect power cord, and disconnect battery before servicing equipment. • Connect only to grounded electrical outlets. • Use only 3-wire extension cords. • Ensure ground prongs are intact on power and extension cords. • Do not expose to rain. Store indoors. • Wait five minutes after disconnecting power cord before servicing.
 	<p>MOVING PARTS HAZARD Moving parts can pinch, cut or amputate fingers and other body parts.</p> <ul style="list-style-type: none"> • Keep clear of moving parts. • Do not operate equipment with protective guards or covers removed. • Equipment can start without warning. Before checking, moving, or servicing equipment, follow the Pressure Relief Procedure and disconnect all power sources.
	<p>BURN HAZARD Equipment surfaces and fluid that’s heated can become very hot during operation. To avoid severe burns:</p> <ul style="list-style-type: none"> • Do not touch hot fluid or equipment.
	<p>TOXIC FLUID OR FUMES HAZARD Toxic fluids or fumes can cause serious injury or death if splashed in the eyes or on skin, inhaled, or swallowed.</p> <ul style="list-style-type: none"> • Read Safety Data Sheet (SDS) to know the specific hazards of the fluids you are using. • Store hazardous fluid in approved containers, and dispose of it according to applicable guidelines.

WARNING



PERSONAL PROTECTIVE EQUIPMENT

Wear appropriate protective equipment when in the work area to help prevent serious injury, including eye injury, hearing loss, inhalation of toxic fumes, and burns. This protective equipment includes but is not limited to:

- Protective eyewear, and hearing protection.
- Respirators, protective clothing, and gloves as recommended by the fluid and solvent manufacturer.



BATTERY HAZARD

The battery may leak, explode, cause burns, or cause an explosion if mishandled. Contents of an open battery can cause severe irritation and/or chemical burns. If on skin, wash with soap and water. If in eyes, flush with water for at least 15 minutes and get immediate medical attention.

- Replace battery only in a well-ventilated area and away from flammable or combustible materials, including paints and solvents.
- When battery is not in use, keep it away from metal objects like keys, nails, screws or other metal objects that can short circuit the battery terminals.
- Do not throw into fire.
- Charge only with Graco approved charger as listed in this manual.
- Do not store or charge at temperatures below 32° or above 113°F (0° to 45°C).
- Do not use at temperatures below 14° or above 140°F (-10° to 60°C).
- Do not expose battery to water or rain.
- Do not disassemble, crush, or penetrate the battery.
- Do not use or charge a battery that is cracked or damaged.
- Follow local ordinances and/or regulations for disposal.



CHARGER ELECTRIC SHOCK, FIRE AND EXPLOSION HAZARD

Improper setup or usage can cause electric shock, fire, and explosion.



- Charge only in a well-ventilated area and away from flammable or combustible materials, including paints and solvents.
- Do not charge on a combustible or flammable surface.
- Do not leave battery unattended while charging.
- Immediately unplug charger when charging is complete.
- Charge only Graco approved batteries listed in this manual; other batteries may burst.
- Use only in dry locations. Do not expose to water or rain.
- Do not use a charger that is cracked or damaged.
- If the supply cord is damaged, replace the charger or cord, depending on model.
- Never force the battery into the charger.
- Disconnect the charger from the outlet before cleaning.
- Ensure that the outside surface of the battery is clean and dry before plugging into the charger.
- Do not attempt to charge non-rechargeable batteries.
- Do not disassemble the charger. Take charger to authorized service center when service or repair is required.

Component Identification (ES 1000)

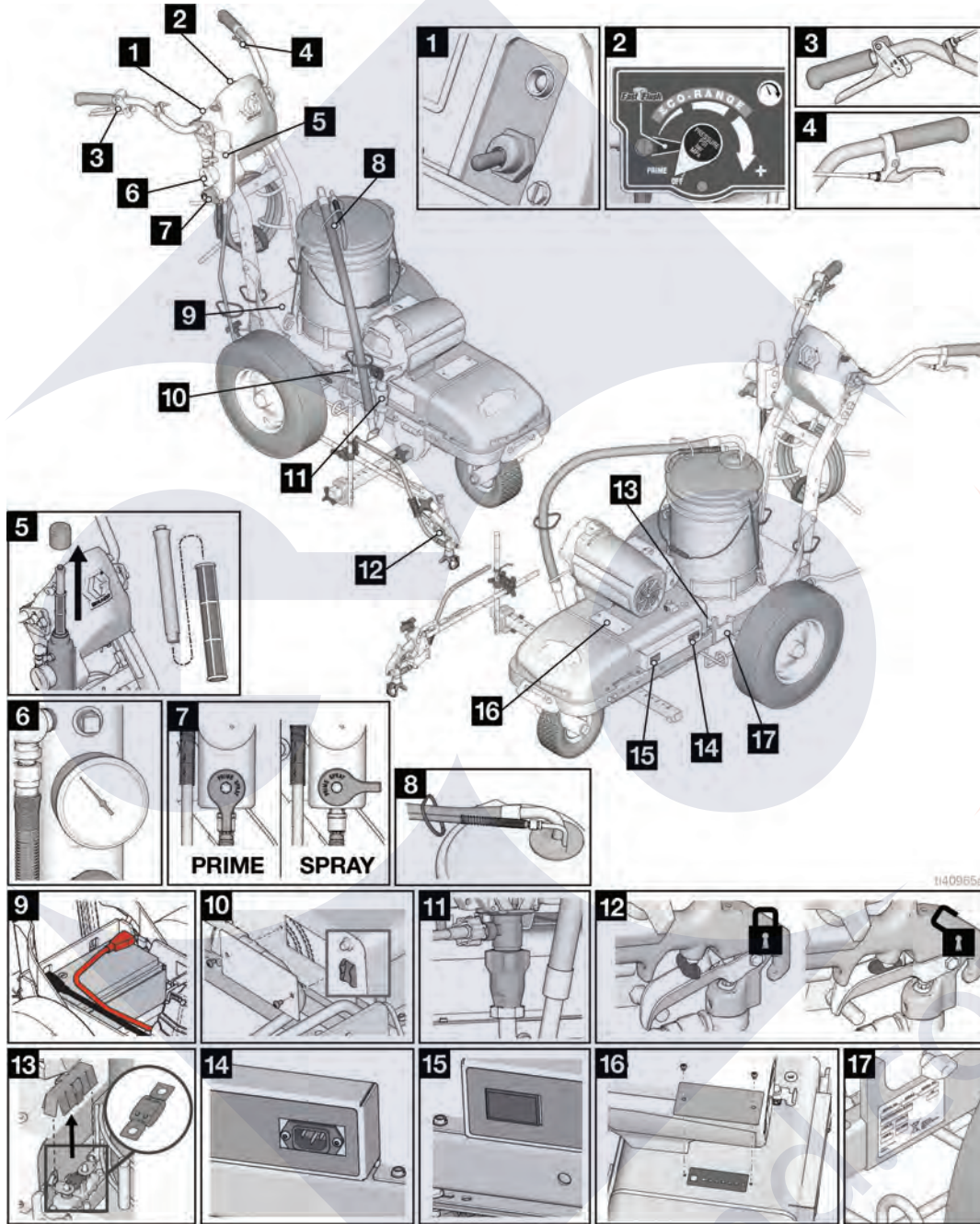

1	ON/OFF Switch
2	Pressure Control & Display
3	Spray Gun Trigger
4	Turn Control
5	Filter
6	Pressure Gauge
7	Prime/Pressure Valves
8	Drain and Siphon Hoses
9	Battery Compartment

10	Inverter Circuit Breakers
11	Pump
12	Trigger Safety
13	Fuse
14	Charging Port
15	Voltage Meter
16	LED Status Center & Battery Type Selector Access
17	Serial ID

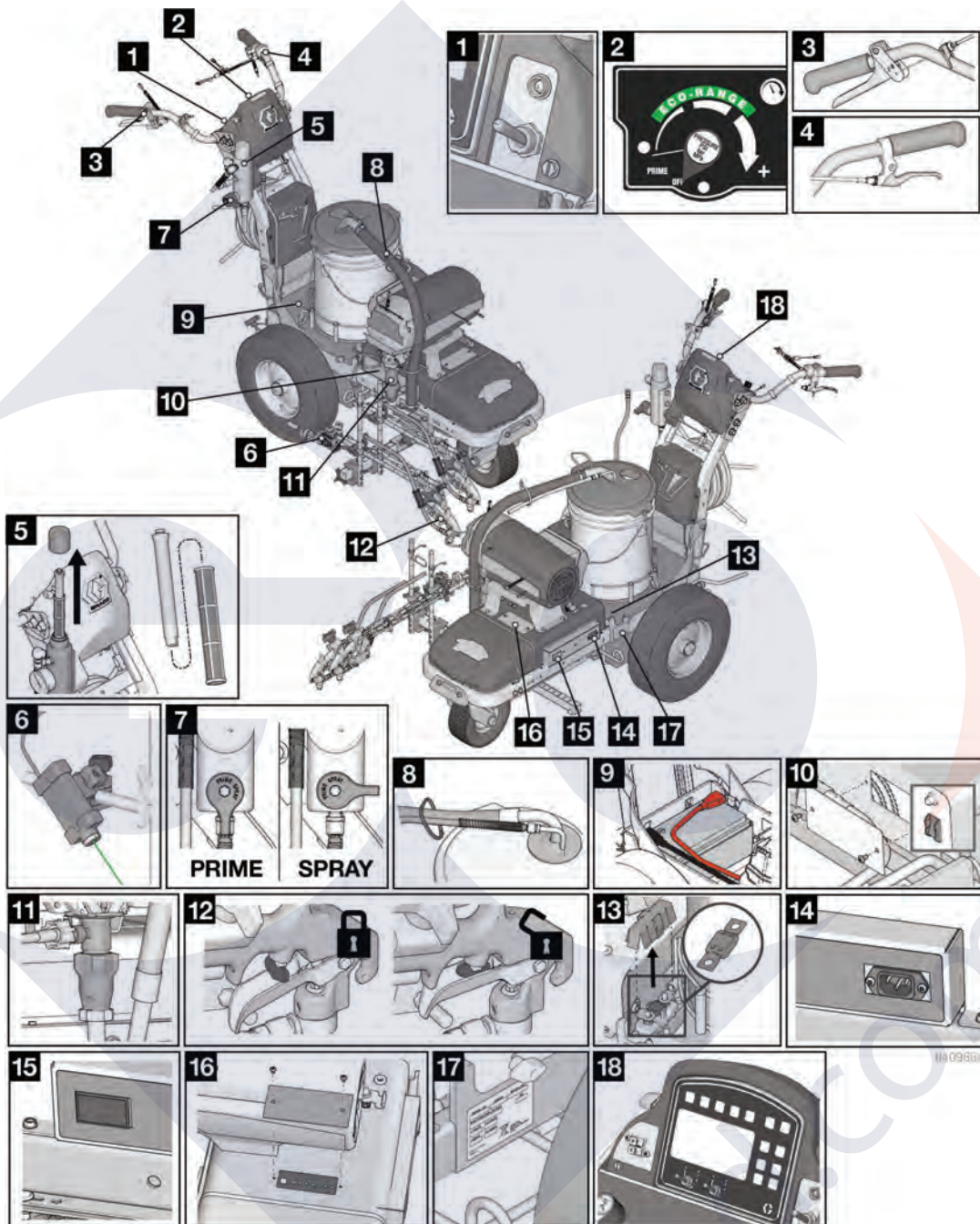

Component Identification (ES 2000)



1	ON/OFF Switch
2	Pressure Control & Display
3	Spray Gun Trigger
4	Turn Control
5	Filter
6	Laser
7	Prime/Pressure Valves
8	Drain and Siphon Hoses
9	Battery Compartment

10	Inverter Circuit Breakers
11	Pump
12	Trigger Safety
13	Fuse
14	Charging Port
15	Voltage Meter
16	LED Status Center & Battery Type Selector Access
17	Serial ID
18	Display

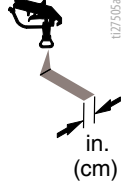
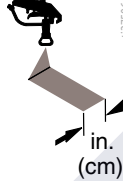
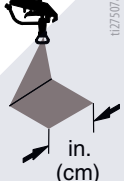
Tip Selection

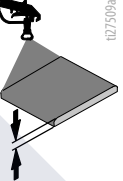
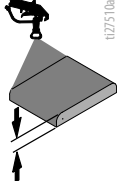
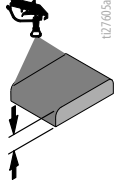
							
	in. (cm)	in. (cm)	in. (cm)	in. (cm)			
LL5213*	2 (5)				✓		
LL5215*	2 (5)					✓	
LL5217		4 (10)				✓	
LL5219		4 (10)					✓
LL5315		4 (10)			✓		
LL5317		4 (10)			✓		
LL5319		4 (10)				✓	
LL5321		4 (10)				✓	
LL5323		4 (10)				✓	
LL5325		4 (10)					✓
LL5327		4 (10)					✓
LL5329		4 (10)					✓
LL5331		4 (10)					✓
LL5333		4 (10)					✓
LL5335		4 (10)					✓
LL5355		4 (10)					✓
LL5417			6 (15)		✓		
LL5419			6 (15)		✓		
LL5421			6 (15)		✓		
LL5423			6 (15)			✓	
LL5425			6 (15)			✓	
LL5427			6 (15)			✓	
LL5429			6 (15)			✓	
LL5431			6 (15)				✓
LL5435			6 (15)				✓
LL5621				12 (30)	✓		
LL5623				12 (30)	✓		
LL5625				12 (30)	✓		
LL5627				12 (30)	✓		
LL5629				12 (30)	✓		
LL5631				12 (30)		✓	
LL5635				12 (30)		✓	
LL5639				12 (30)			✓

*Use 100 mesh filter to reduce tip clogs.

Battery and Charger

NOTICE

If the battery level is below 9.7V, the on-board charger will not be allowed to charge the battery. Charge battery with an external charger to raise the level above 10.0V to activate the on-board charger, or replace the battery.

NOTICE



Do not expose sprayer to rain or wash down. Exposure could cause damage to electrical components. Store and transport covered or indoors.

Use your smartphone's camera to scan and download the Power Sonic Quick Guide and Battery App.



For best performance, Graco recommends using only lithium ion batteries. The LineLazer is shipped with one or two Power Sonic Lithium (LiPO4) batteries. If powering the LineLazer with lithium batteries, Graco recommends using the Power Sonic brand.

For Power Sonic Lithium batteries, use switch position 2 on the battery type selector. If you need to adjust the battery type switch position, use a small flat head screw driver to turn the arrow to point at the number that correlates with the chosen battery. See chart below:

BATTERY TYPE SELECTOR SETTINGS

Switch Position	Description	Boost/Vdc	Float/Vdc
0	Charger Off		
1	Gel USA	14.0	13.7
2	Power Sonic Lithium	14.1	13.4
3	AGM 2	14.6	13.7
4	Sealed Lead Acid	14.4	13.6
5	Gel Euro	14.4	13.8
6	Open Lead Acid	14.8	13.3
7	LiFePO4	14.4	14.4
8	De-sulphation	15.5 (4 hours then Off)	
9	Not used		

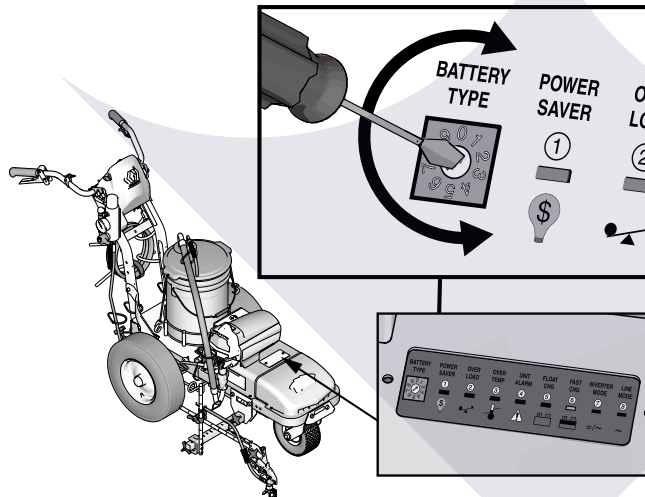

t30488a

Grounding Procedure to Charge Batteries



This equipment must be grounded to reduce the risk of static sparking and electric shock. An electric shock or static spark can cause fumes to ignite or explode. An improper ground can cause electric shock. A good ground provides an escape wire for the electric current.

Position the striper so the wheels are on a true grounded surface. Not on pavement.

The power cord must be plugged into an outlet that is properly installed and grounded in accordance with all local codes and ordinances.

Do not modify the plug provided; if it does not fit the outlet, have the proper outlet installed by a qualified electrician.

Power Requirements

- 100-120V units require 100-120 VAC, 50/60 Hz, 12 or 15A, 1 phase.
- 230V units require 230 VAC, 50/60 Hz, 7 or 9A, 1 phase.

Charge the Battery

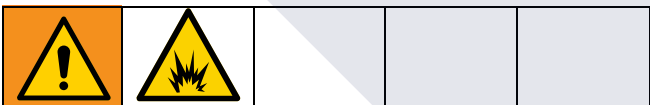

Replace and charge battery only in well-ventilated area and away from flammable or combustible materials, including paints and solvents.

Use an extension cord with an undamaged ground contact. If an extension cord is necessary, use a 3-wire, 12 AWG (2.5 mm²) minimum.

Check battery level on the Power Sonic Smart Battery app. New batteries are approximately 50% capacity for shipping.

1. Place unit in dry, well-ventilated area and away from flammable or combustible materials, including paints and solvents.

2. Ensure power switch is in **OFF** position.

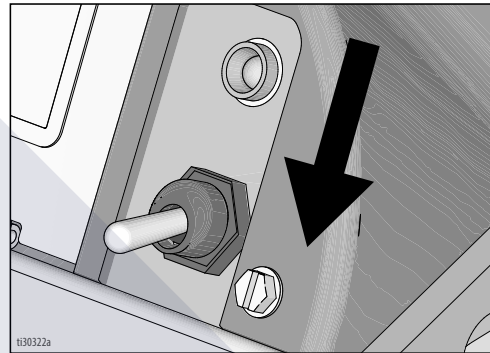

3. Plug charging cord into charging port on the unit. Connect an extension cord, minimum 12AWG (2.5mm²), to the charging cord and plug it into wall power.

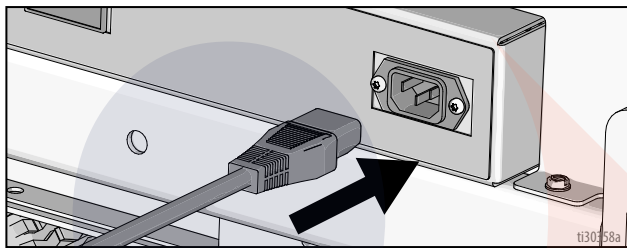

4. When power is connected the voltmeter will turn on and the charger will immediately begin charging. User should be able to see voltmeter start to climb to indicate charging is occurring.



5. Battery will charge to 14.6-14.8 volts and then it will come back down to ~13.6 volts when fully charged.



6. Unplug charger when fully charged.

Grounding Instructions

(Flammable Flushing and Cleaning Materials)



This equipment must be grounded to reduce the risk of static sparking. A static spark can cause fumes to ignite or explode causing serious injury. A good ground provides an escape wire for the electric current.

Position the striper so the wheels are on a true grounded surface, not on pavement or in the back of a trailer or a truck.

The striper is equipped with a grounding wire and clamp. The clamp must be connected to a true earth ground when flushing with flammable materials. See **Important Grounding Information**, page 5.

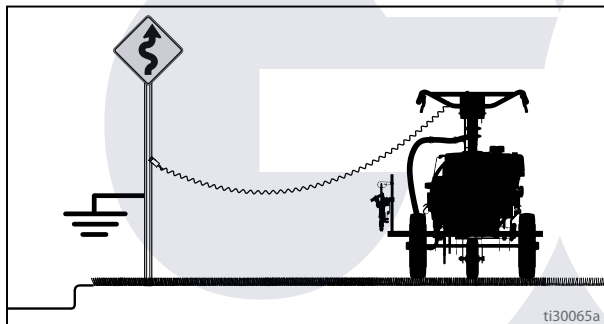

A metal sign post can be used as a true earth ground. Connect the grounding wire and clamp to a metal post. A properly grounded electrical outlet can also be used as a true earth ground. Use the provided adapter.

Plug the adapter in to a grounded outlet. Connect the grounding wire and clamp to the metal stud on the adapter. If the ground wire is not long enough to reach a grounded electrical outlet, use a 3-wire grounded extension cord between the adapter and outlet.

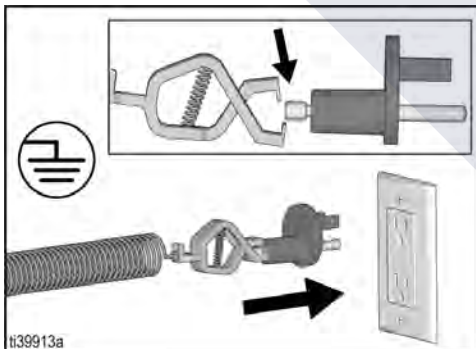

Fluid hoses: Use only electrically conductive hoses with a maximum of 300 ft. (91 m) combined hose length to ensure grounding continuity.

Spray gun: Grounded through connection to a properly grounded fluid hose and pump.

Pails

Flammable materials: follow local codes and regulations. Use only conductive metal pails, placed on a grounded surface such as concrete.

Do not place pail on a non-conductive surface such as paper or cardboard which interrupts grounding continuity.

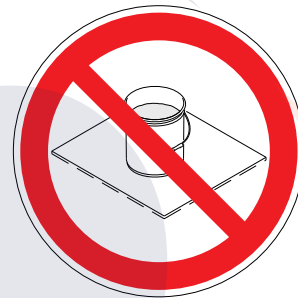

Always ground a metal pail: connect a ground wire to the pail. Clamp one end to the pail and the other end to a true earth ground such as a water pipe.

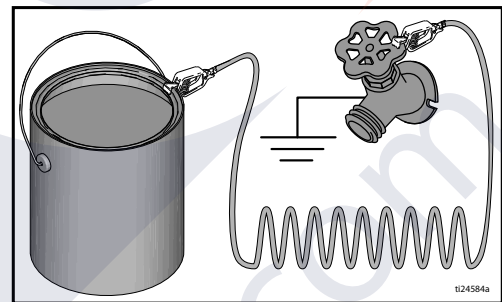

To maintain ground continuity when sprayer is flushed or pressure is relieved: hold metal part of spray gun firmly to the side of a grounded metal pail then trigger the gun.



Pressure Relief Procedure

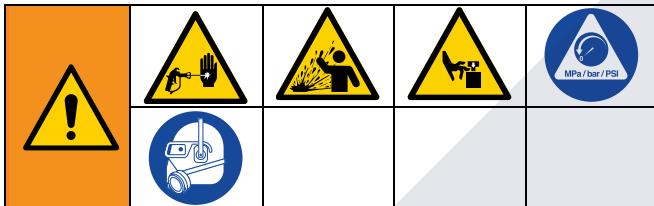

This equipment stays pressurized until pressure is manually relieved. To help prevent serious injury from pressurized fluid, such as skin injection, splashing fluid and moving parts, follow the **Pressure Relief Procedure** when you stop dispensing and before cleaning, checking, or servicing the equipment.

1. Perform **Grounding Instructions**, page 15 if using flammable materials.
2. Turn ON/OFF Switch to **OFF**.

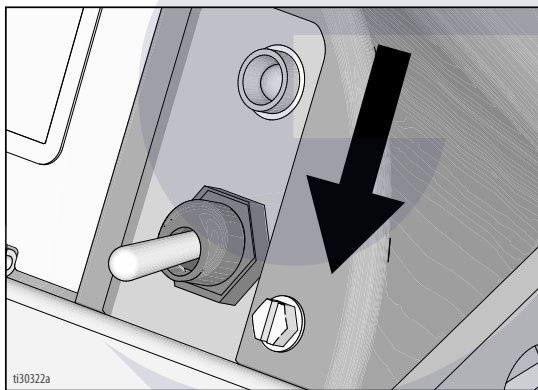

3. Turn pressure control to lowest setting. Trigger all guns to relieve pressure.

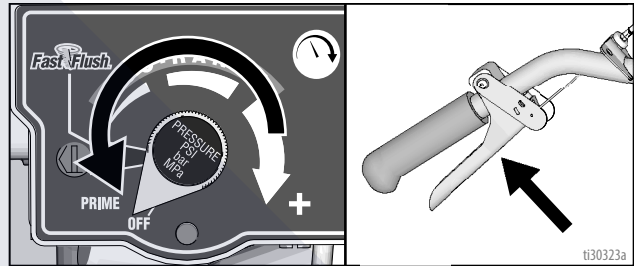

4. Engage all gun trigger locks. Turn prime valve down.

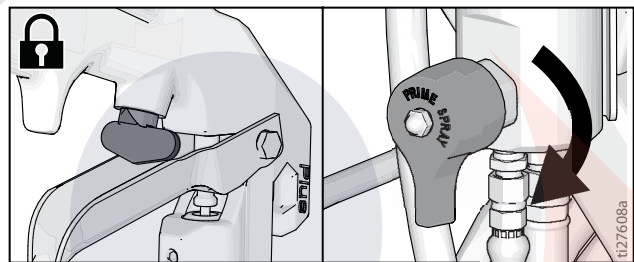

5. If you suspect the spray tip or hose is clogged or that pressure has not been fully relieved:
 - a. **VERY SLOWLY** loosen the tip guard retaining nut or the hose end coupling to relieve pressure gradually.
 - b. Loosen the nut or coupling completely.
 - c. Clear the obstruction in the hose or tip.

goind.com.au

Setup

When unpacking sprayer for the first time or after long term storage, perform setup procedure.

1. Fill throat packing nut with TSL to prevent premature packing wear.
 - a. Place the TSL bottle nozzle into the top center opening in the grill at the front of the sprayer.
 - b. Squeeze bottle to dispense enough TSL to fill the space between the pump rod and packing nut seal.

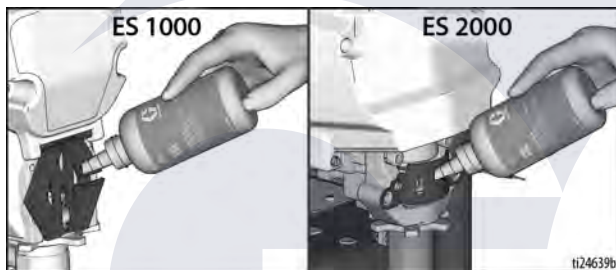

2. If removed, install strainer.

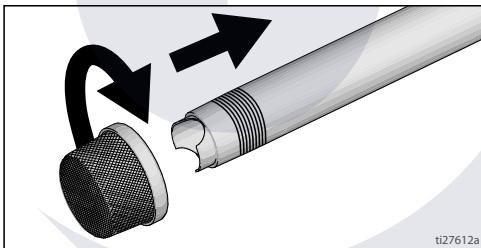

SwitchTip™ and Guard Assembly



To avoid serious injury from skin injection do not put your hand in front of the spray tip when installing or removing the spray tip and tip guard.

1. Engage trigger lock. Use end of SwitchTip to press OneSeal™ into tip guard, with curve matching tip bore.

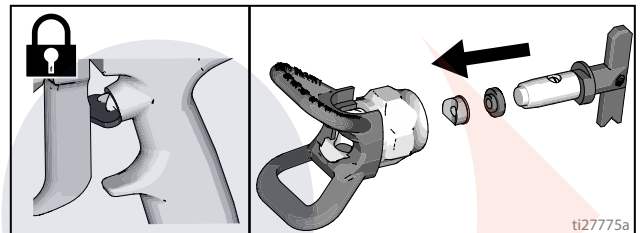

2. Insert SwitchTip in tip bore and firmly thread assembly onto gun.

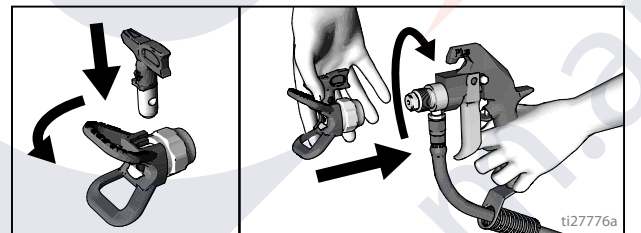

Startup

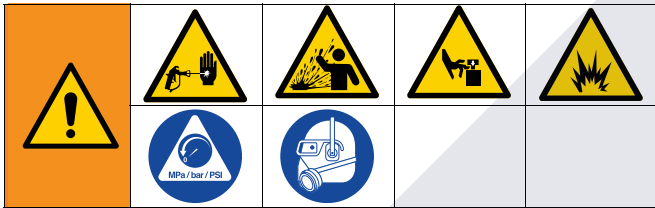

1. Perform **Grounding Instructions**, page 15, if using flammable flushing materials.
2. Make certain ON/OFF Switch is **OFF**.

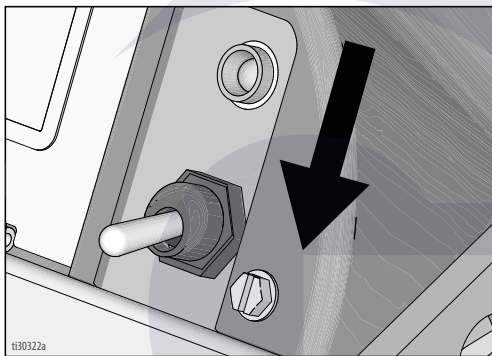

3. Turn prime valve down. Turn pressure control counterclockwise to lowest pressure.

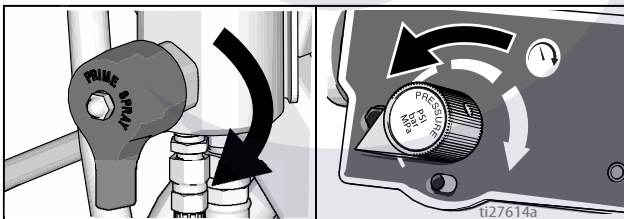

NOTE: Minimum hose size for proper sprayer operation is 1/4 in. x 50 ft for LL ES 1000 and 3/8 x 20' for ES 2000.

4. Place siphon tube set in grounded metal pail partially filled with flushing fluid. Attach ground wire to true earth ground. Use water to flush water-based paint and flammable materials to flush oil-based paint and storage oil.

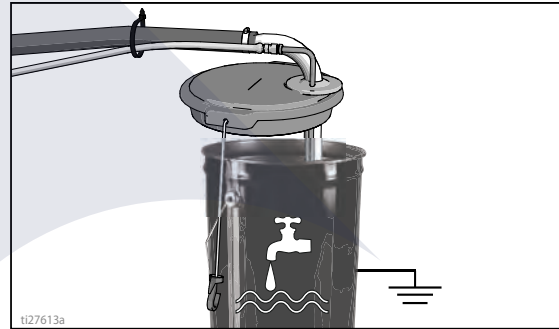

5. Turn ON/OFF Switch to ON.

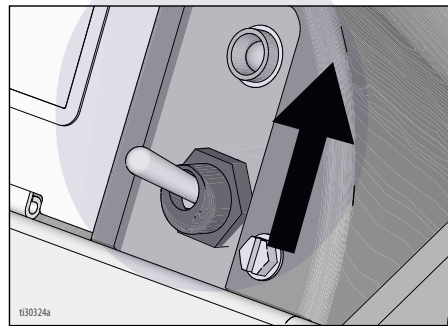

6. **ES 1000:** Turn pressure control to prime. Allow fluid to circulate for 15 seconds.

ES 2000: Increase pressure 1/2 turn to start motor and allow fluid to circulate for 15 seconds.

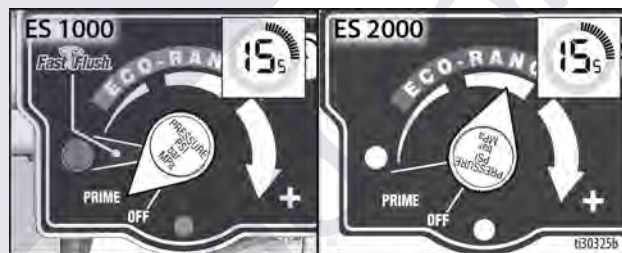

- Turn pressure down, turn prime valve horizontal. Disengage gun trigger lock.

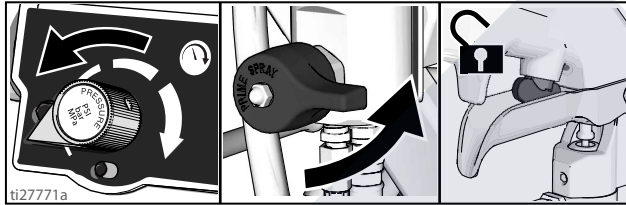

- Hold all guns against a grounded metal flushing pail. Trigger guns and increase fluid pressure slowly until pump runs smoothly to spray.

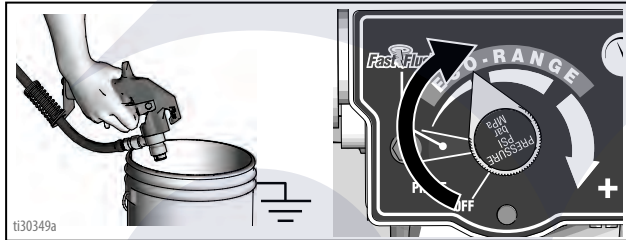

- Place siphon tube in paint pails.

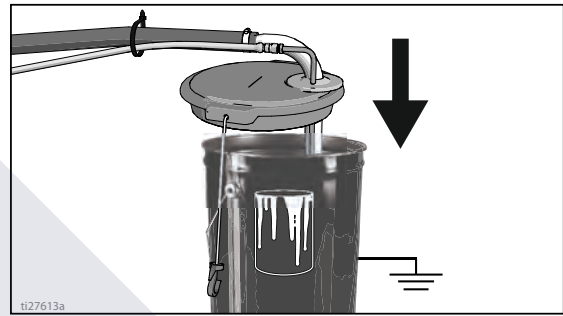

- Trigger all guns again into a flushing fluid pail until paint appears. Assemble tips and guards.

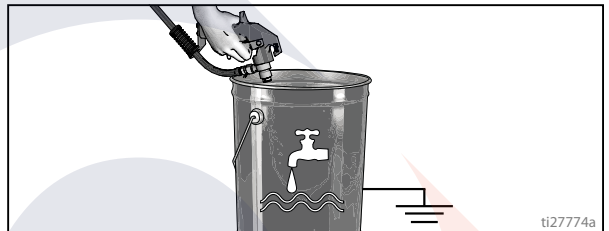

High-pressure spray is able to inject toxins into the body and cause serious bodily injury. Do not stop leaks with hand or rag.

- Inspect fittings for leaks. If leaks occur, turn sprayer OFF immediately. Perform **Pressure Relief Procedure**, page 16. Tighten leaky fittings. Repeat **Startup**, steps 1 - 13. If no leaks, continue to trigger gun until system is thoroughly flushed. Proceed to step 14.

- ES 2000:** Digital display is functional when unit is turned on.

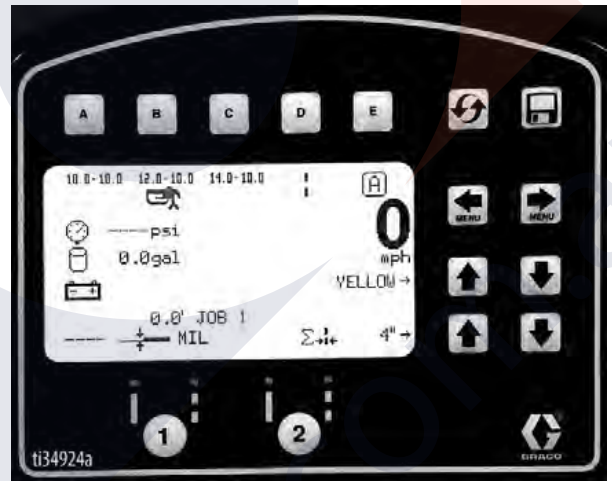

Gun Placement



To avoid serious injury from skin injection do not put your hand in front of the spray tip when installing or removing the spray tip and tip guard.

Install Gun

1. Insert guns into gun holder. Tighten clamps.

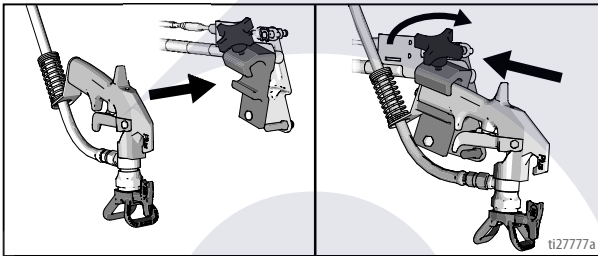

Position Gun

2. Position gun: up/down, forward/reverse, left/right. See **Gun Positions Chart**, page 22 for examples.

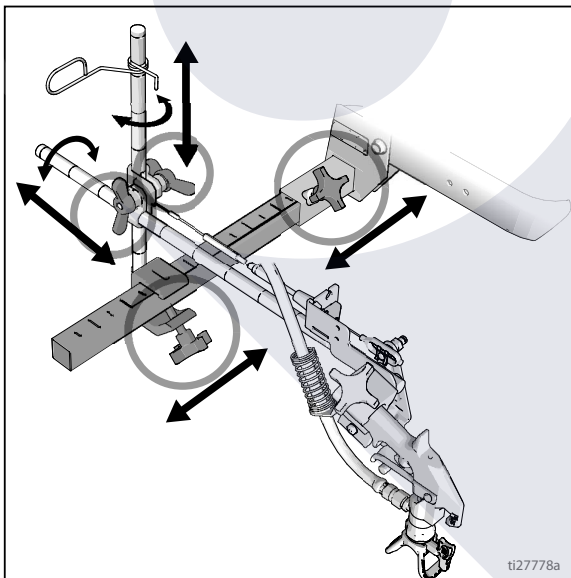

NOTE: When striping above a curb, the mounting clamp can be rotated for clearance.

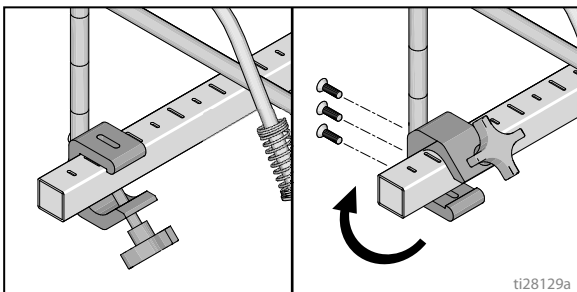

Another option can be to swing the gun out at an angle and rotate the tip guard. This results in better visibility for the user.

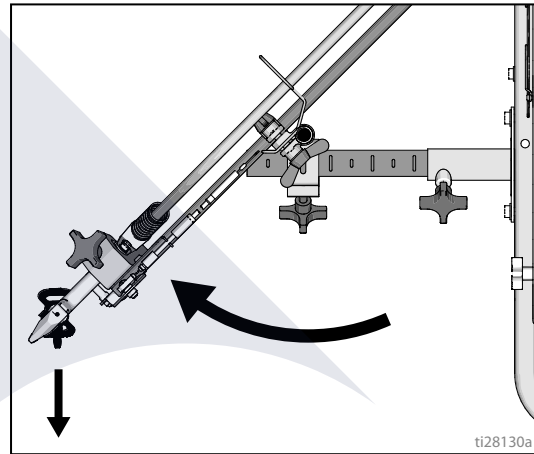

Select Manual Guns

3. Connect gun cables to left or right gun selector plates.

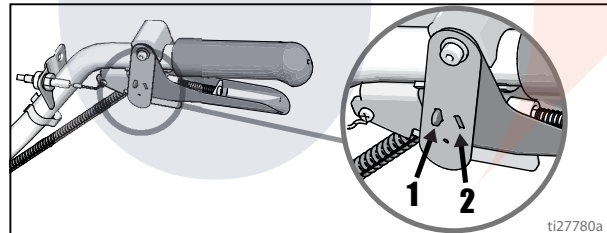

- a. One gun: Disconnect one gun selector plate from trigger.



- b. Both guns simultaneously: Adjust both gun selector plates to the same position.



- c. Solid-skip and skip-solid: Adjust solid-line gun to position 1 and skip-line to position 2.



Select Auto Guns (ES 2000)

1. Use the gun selector buttons to determine which guns are active. Each gun selector has 3 settings: continuous line, OFF and programmed line pattern.

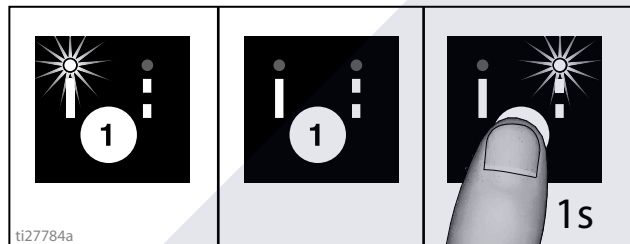

2. Use the gun trigger control to actuate auto guns.

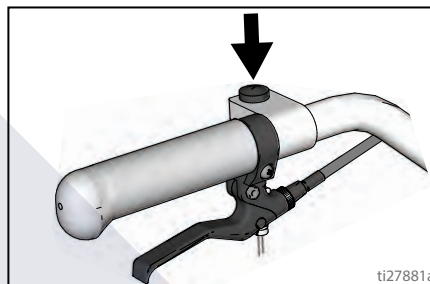

4 Examples:

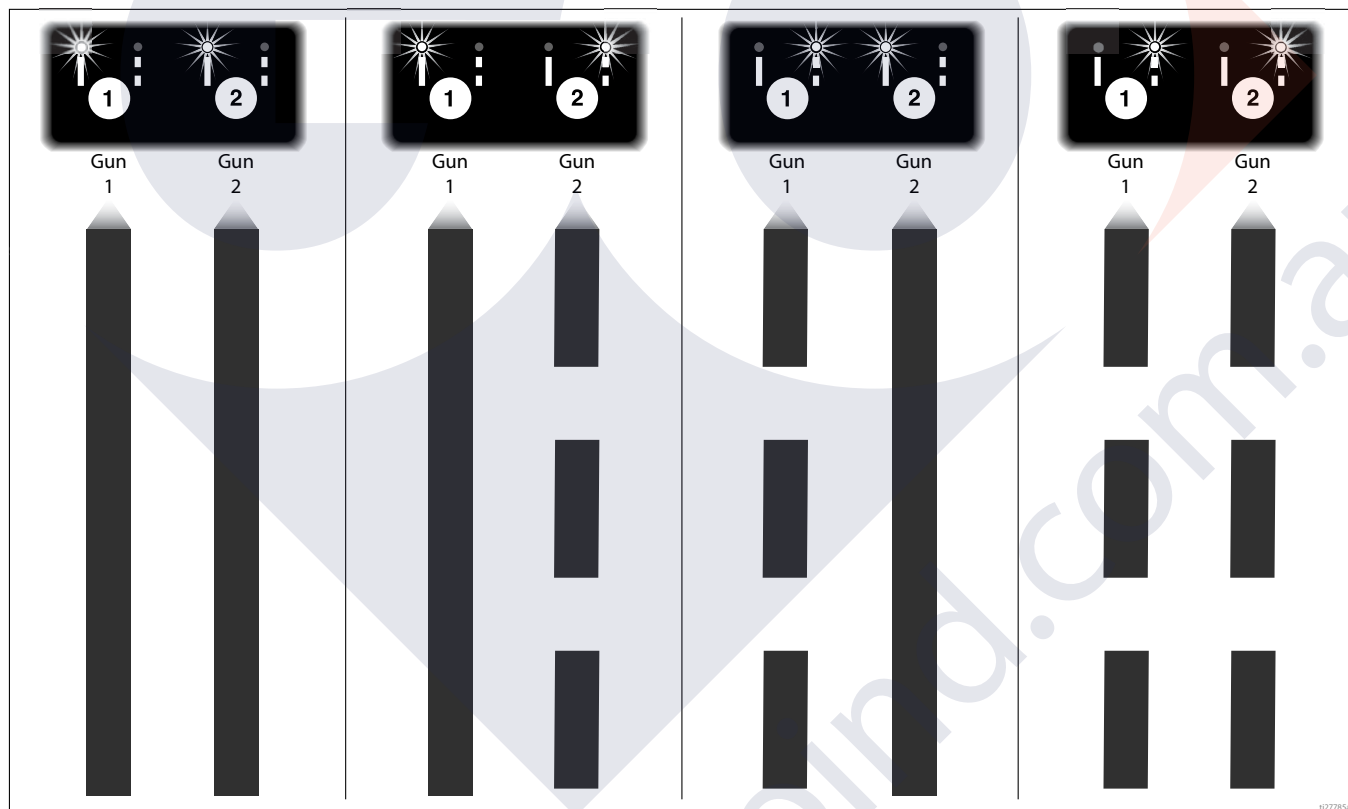

Gun Positions Chart

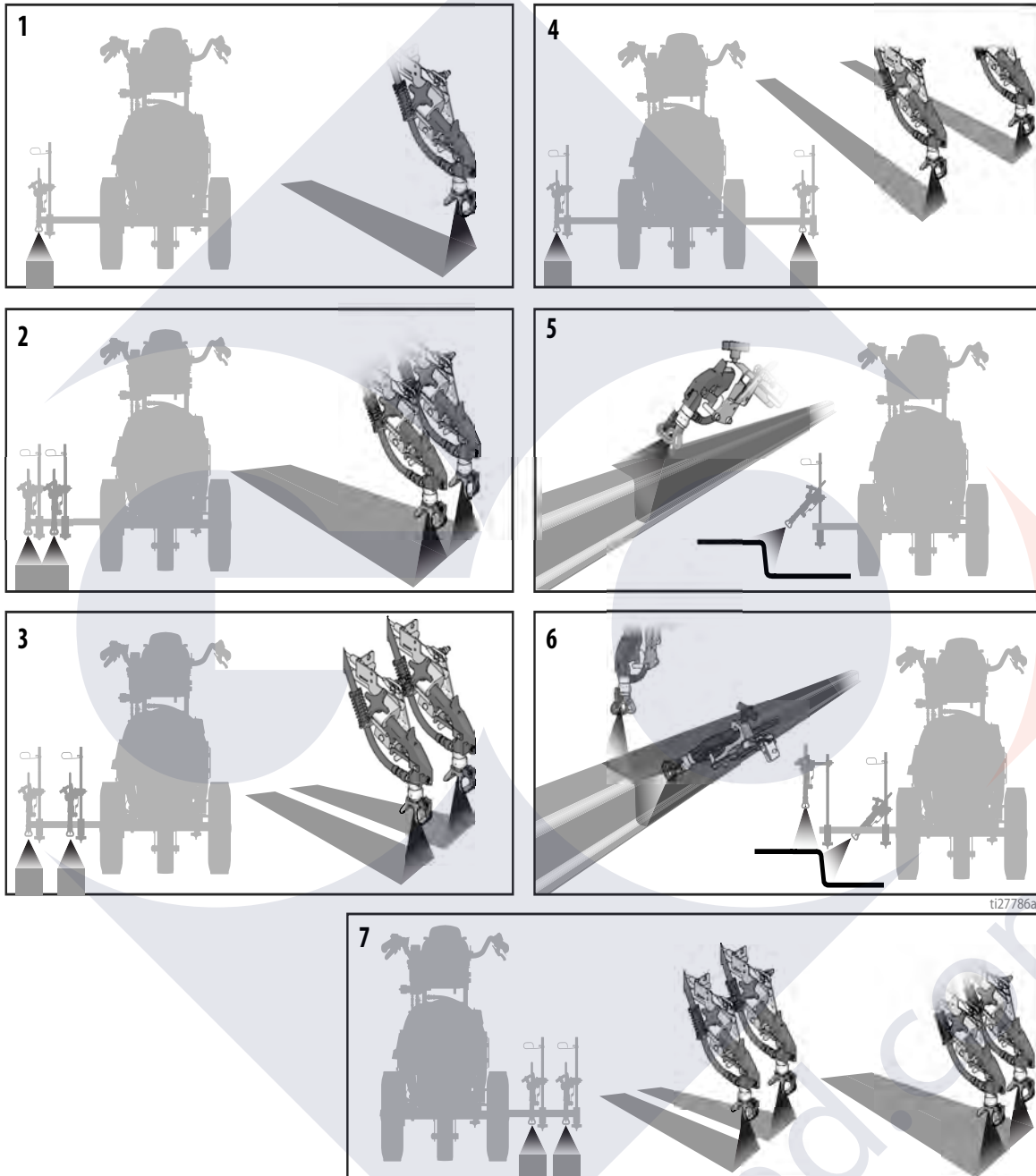

1	One line
2	One line up to 24 in. (61cm) wide
3	Two lines
4	One line or two lines to spray around obstacles
5	One gun curb
6	Two gun curb
7	Two lines or one line up to 24 in. (61 cm) wide

Gun Arm Mounts

This unit is equipped with front and rear gun arm mounts.

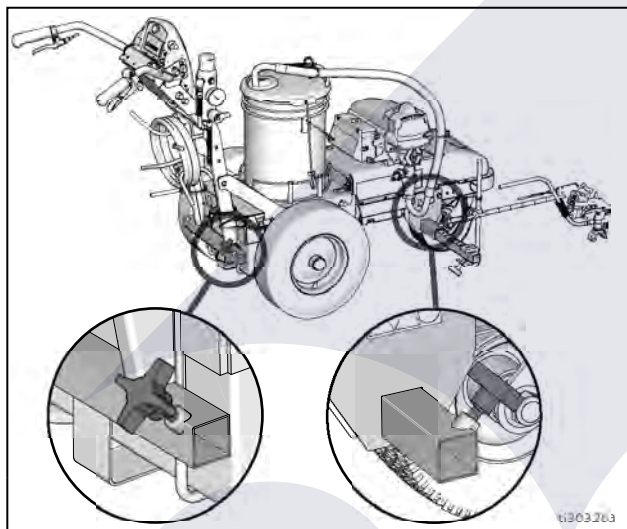

Change Gun Position (Front and Back)

1. Loosen gun arm knob and remove from gun arm mounting slot.

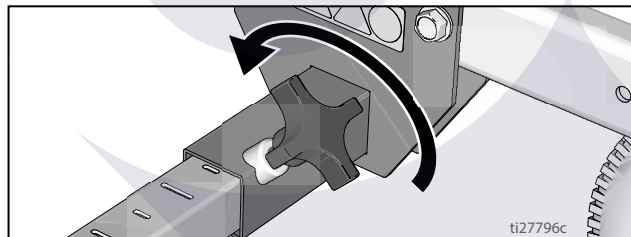

2. Slide gun arm assembly (including gun and hoses) out from gun arm mounting slot.

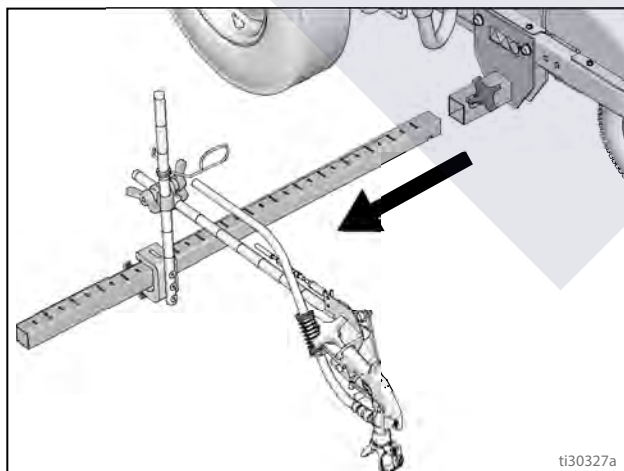

3. Slide gun arm assembly into desired gun arm mounting slot.

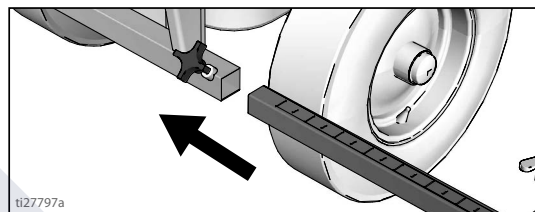

4. Tighten gun arm knob into gun arm mounting slot.

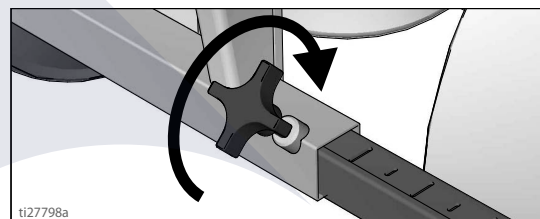

NOTICE

Make sure all hoses, cables, and wires are properly routed through brackets and do NOT rub on tire. Contact with tire will result in damaged hoses, cables, and wires.

Change Gun Position (Left and Right)

Removal

1. Loosen vertical gun arm knob on gun arm mounting bar and remove.

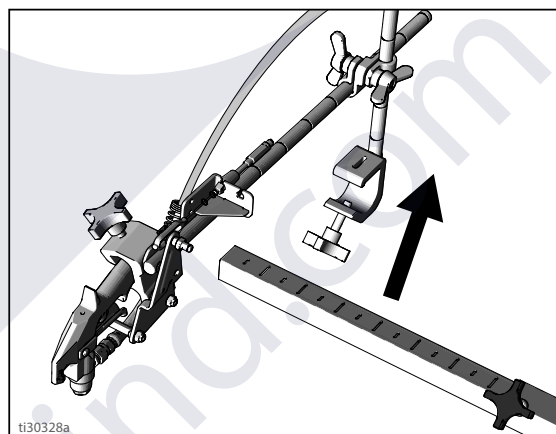

2. Extend mounting bar on opposite side of the machine.

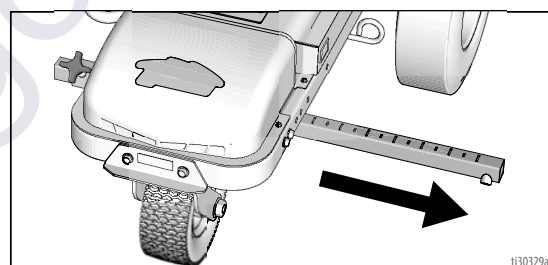

Installation

1. Install vertical gun mount onto gun bar.

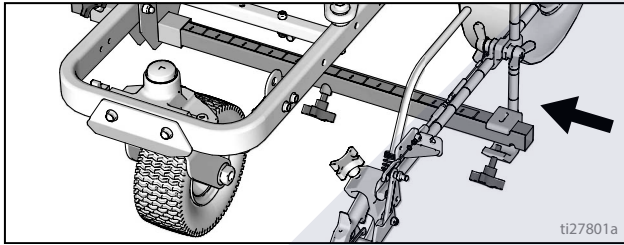

NOTE: Make sure all hoses, cables, and wires are properly routed through brackets.

Trigger Sensor Adjustment (ES 2000)

1. Turn striper on. Engage trigger. Spray icon should appear simultaneously with start of fluid spray.

ES 2000

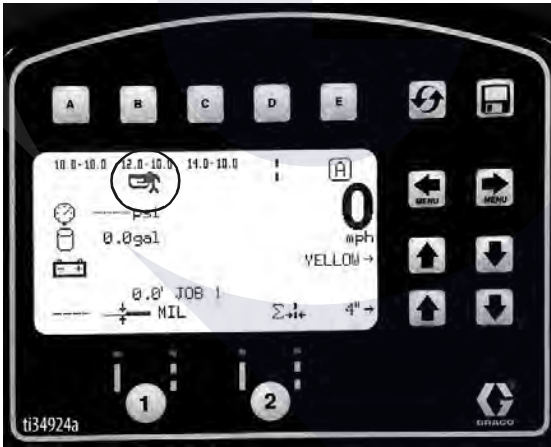

No fluid spray

2. Turn screw in handle clockwise if spray icon appears before fluid spray starts.

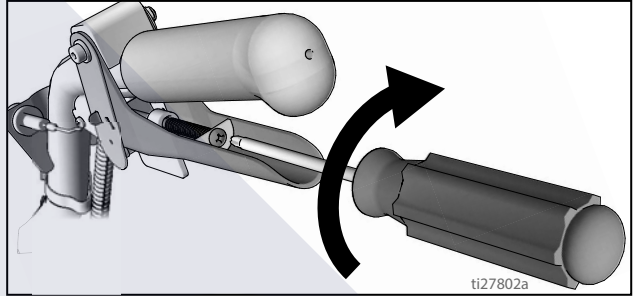

No spray icon

3. Turn screw in handle counterclockwise if fluid spray starts before spray icon appears.

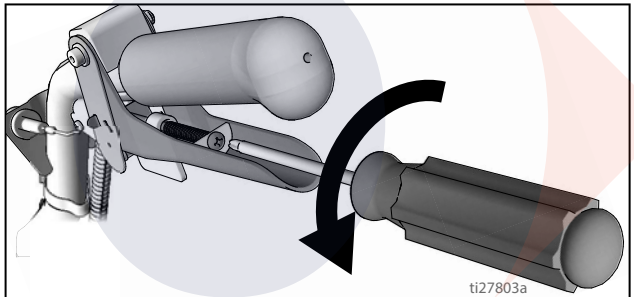

4. Continue adjusting screw in handle until timing of spray icon and fluid spray are synchronized. Adjustment of the gun cables might be necessary.

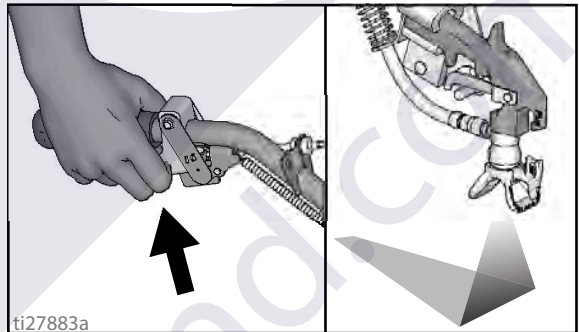

Gun Cable Adjustment

Adjusting the gun cable will increase or decrease the gap between the trigger plate and the gun trigger. To adjust trigger gap, perform the steps below.

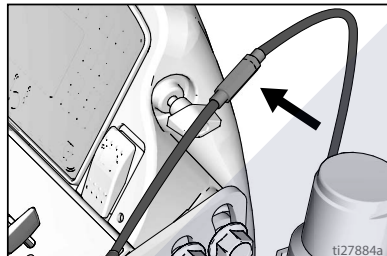

ES 1000 & ES 2000

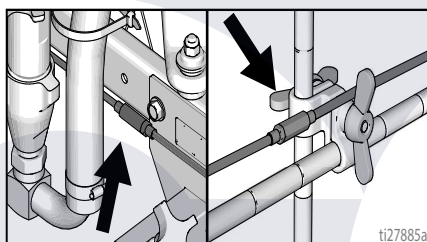

ES 2000

1. Use wrench to loosen locking nut on cable adjuster.

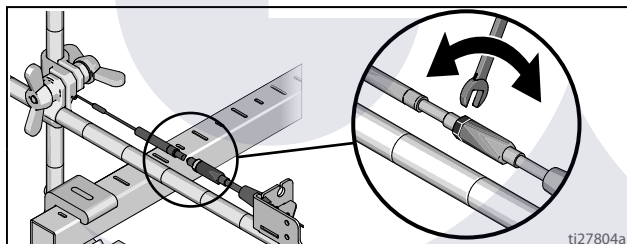

2. Loosen or tighten adjuster until desired result is achieved. **NOTE:** More thread exposed means less gap between gun trigger and trigger plate.
3. Use wrench to tighten locking nut on the adjuster.

Adding Gun Cable (ES 2000)

The ES 2000 can be equipped with two gun actuators. Each gun actuator is capable of operating one cable.

1. Select cable end with adjuster.
2. Install exposed cable through cable bracket slot.

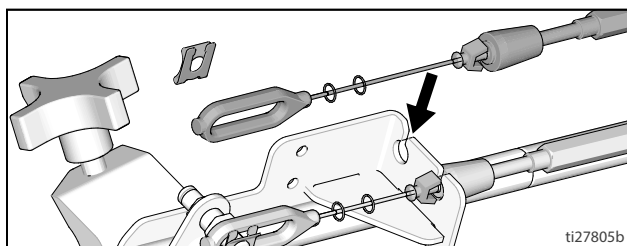

3. Insert plastic cable retainer into cable bracket hole.

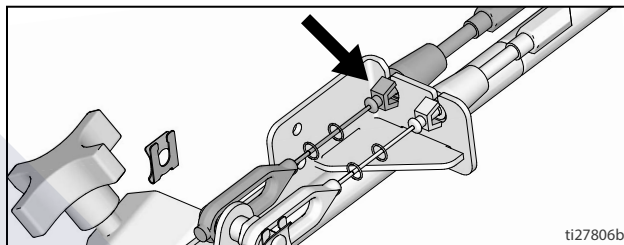

4. Install cable end onto trigger plate pin and install clip.

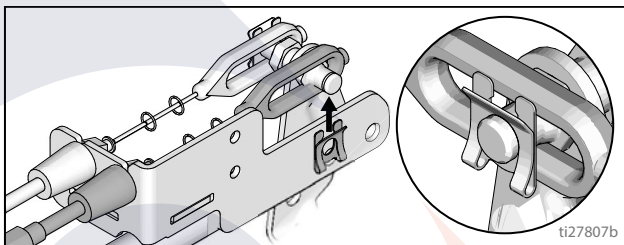

5. Route cable around unit and up through cable holes behind hose mount.

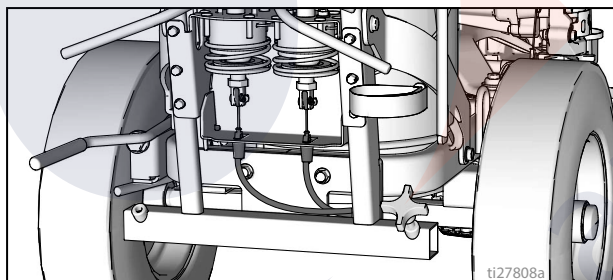

6. Route cable end loop through rectangular hole in bracket and insert plastic cable retainer into the actuator bracket. Install cable end onto actuator rod and install pin.

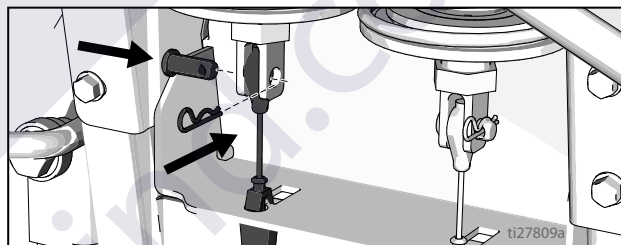

Straight Line Adjustment

The front wheel is set to center the unit and allow the operator to form straight lines. Over time, the wheel may become misaligned and will need to be readjusted. To re-center the front wheel, perform the following steps:

1. Loosen bolt on the front wheel bracket.

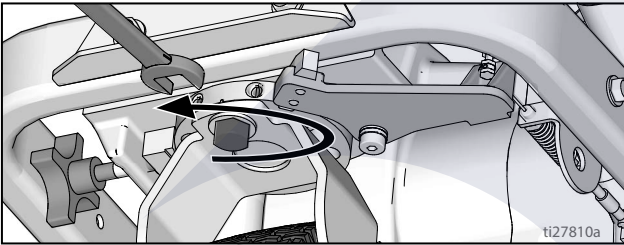

2. If striper arcs to the right, loosen left set screw and tighten right set screw for fine tune adjustment.

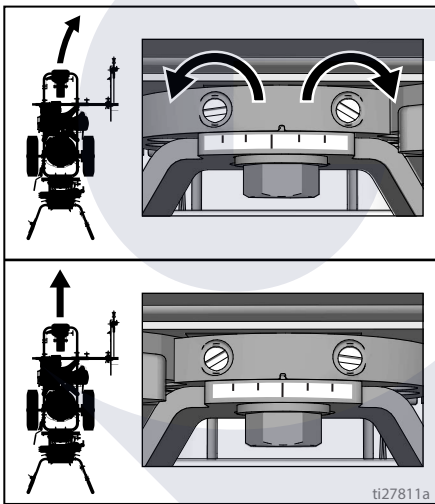

3. If striper arcs to the left, loosen right set screw and tighten left set screw.

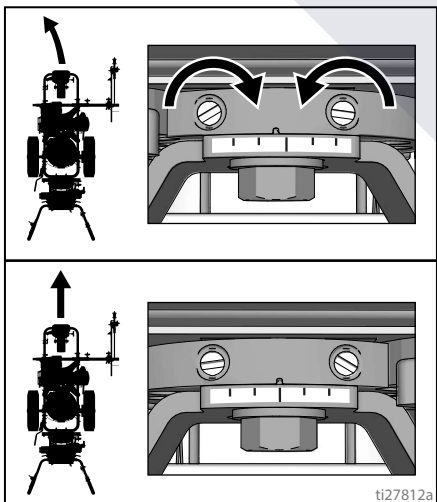

4. Roll the striper. Repeat steps 2 and 3 until striper rolls straight. Tighten bolt on wheel alignment plate to lock the new wheel setting.

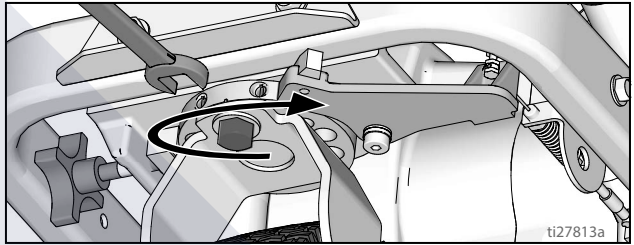

Handle Bar Adjustment

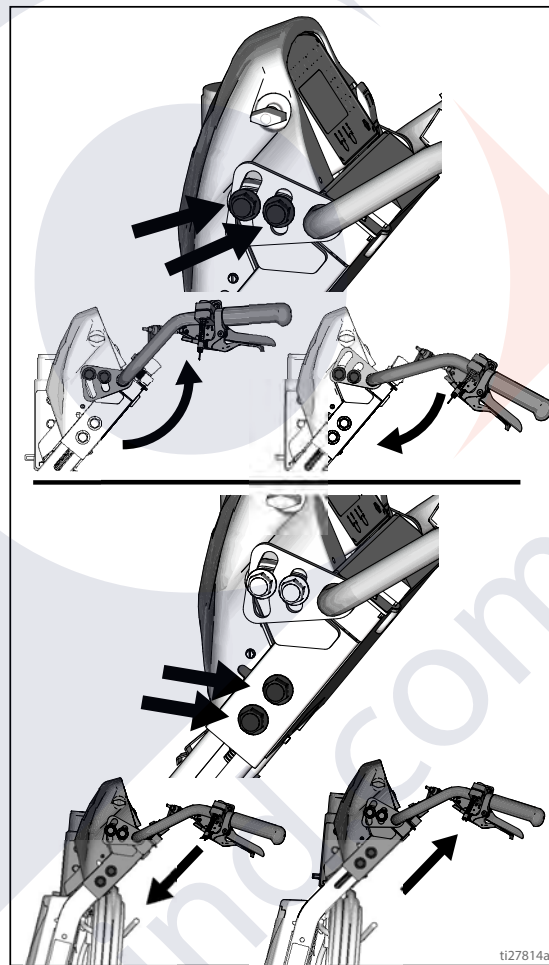

Paint Stripe Width

1. Adjust gun up or down to change paint stripe width.

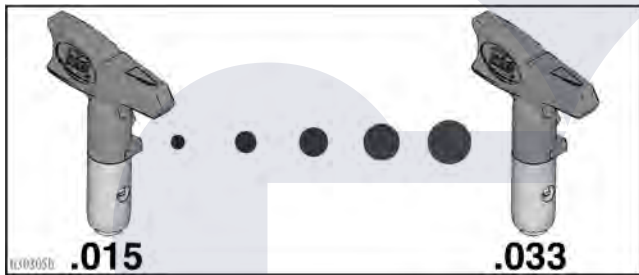
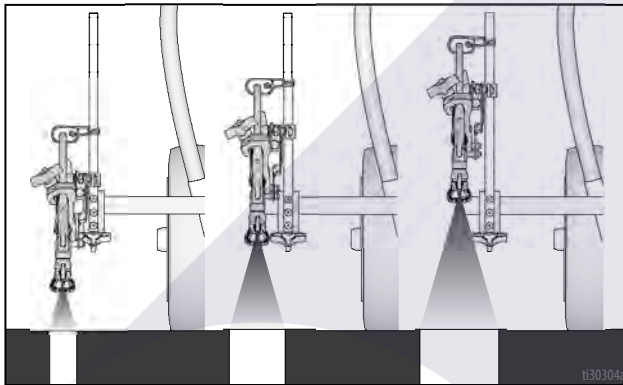

2. Trigger gun and spray test pattern. Slowly adjust pressure to eliminate heavy edges. Use smaller tip size if pressure adjustment can not eliminate heavy edges.

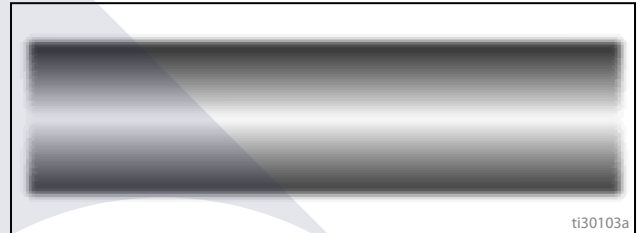

Spray Test Stripe

1. Disengage trigger lock.

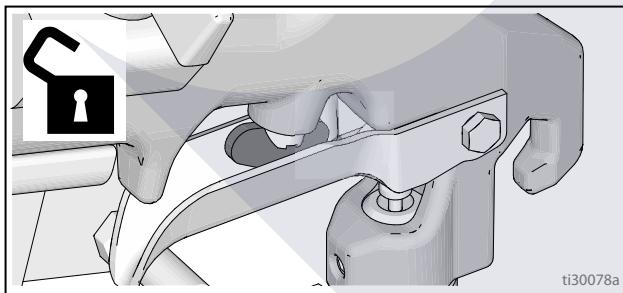

Clearing Tip Clogs



1. Release trigger. Engage gun trigger lock. Rotate SwitchTip. Disengage gun trigger lock and trigger gun to clear the clog.

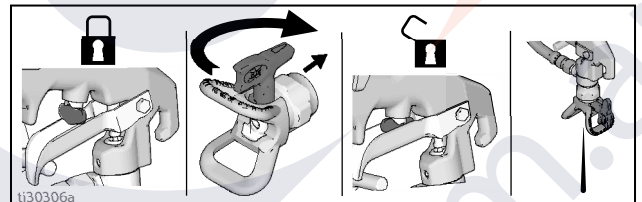

2. Engage gun trigger lock, return SwitchTip to original position, disengage gun trigger lock and continue spraying.

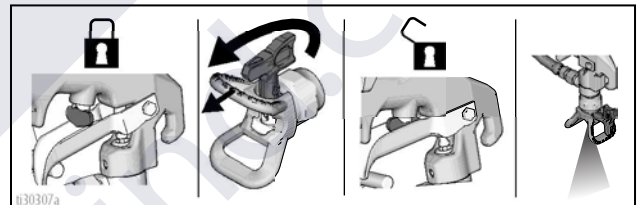

Cleanup



1. Perform **Pressure Relief Procedure**, page 16.
2. Remove guard and SwitchTip from all guns.

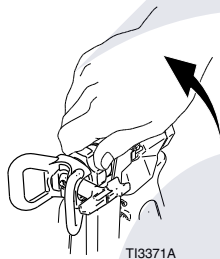

3. Unscrew cap, remove filter. Assemble without filter.

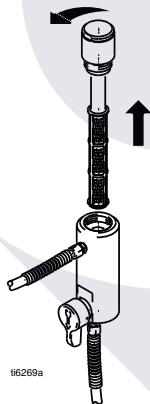

4. Clean filter, guard and SwitchTip in flushing fluid.



5. Attach ground wire to true earth ground or plug unit into grounded outlet.

Flush Drain Tube

6. Remove fluid intake and drain tube from paint, wipe excess paint off outside.

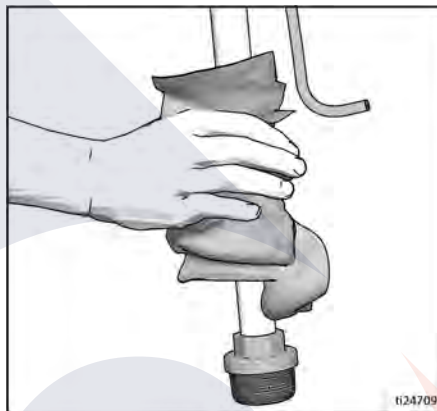

7. Place siphon tube set in grounded metal pail partially filled with flushing fluid. Use water for water-base paint and flammable materials for oil-based paint.
8. To flush drain tube and pump turn prime valve down.

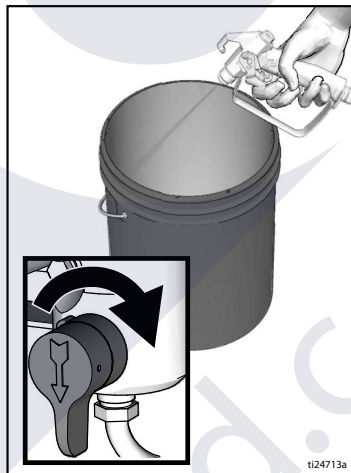

9. Turn pressure control to Fast Flush (ES 1000), or 1/2 position (ES 2000), and operate until the pump runs steady and flushing fluid appears in the waste pail.

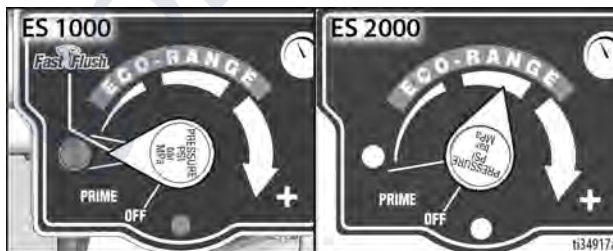

Flush Hose and Gun

10. To flush airless hose and spray gun, turn prime valve horizontal.
11. Hold gun against waste pail. Disengage trigger lock. Trigger gun and turn pressure control to Fast Flush (ES1000), or 1/2 position (ES2000), and operate until the pump runs steady and flushing fluid appears.
12. Stop triggering gun.
13. Fill pump with Pump Armor and reassemble filter, guard and SwitchTip.
14. Each time you spray and store, fill throat packing nut with TSL to decrease packing wear.

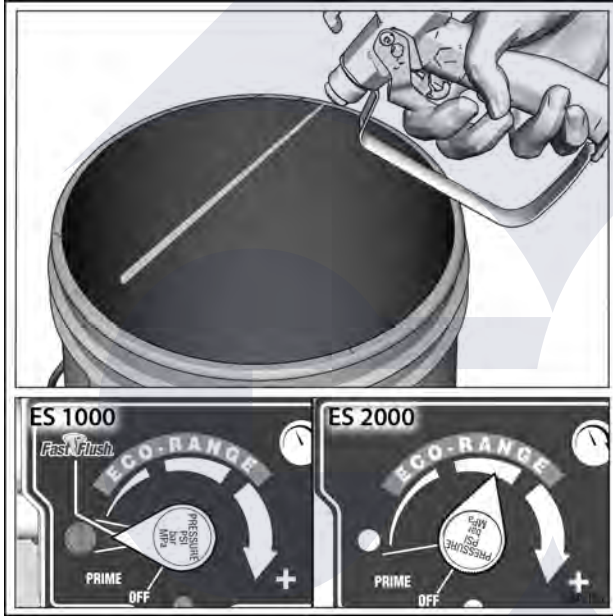

LineLazer V LiveLook™ Display

ES 2000 (Standard Series)

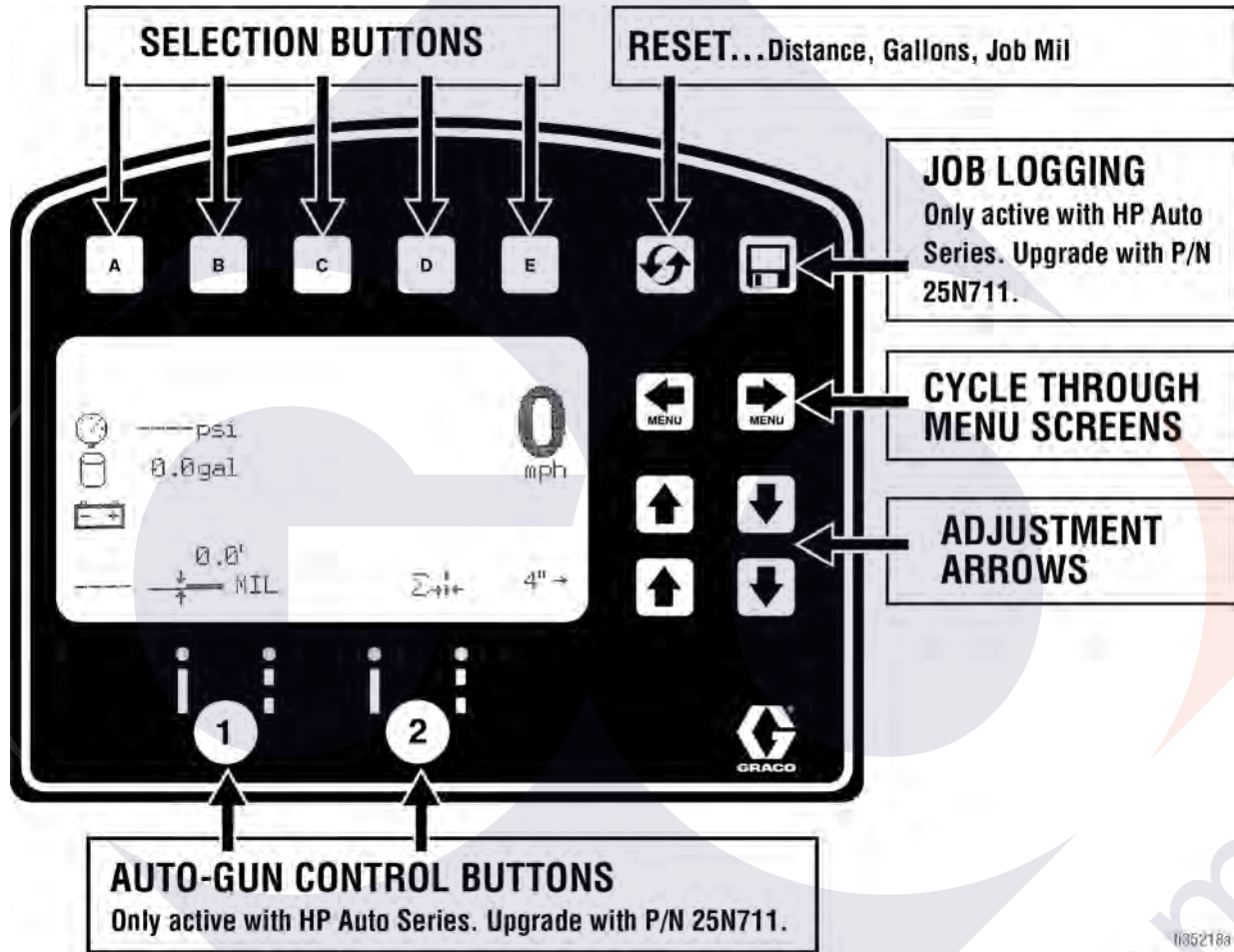

STRIPING SCREEN

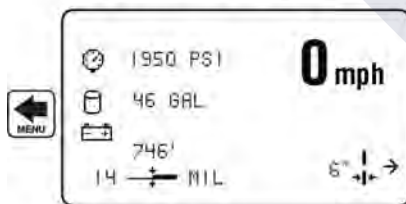

- Displays:
 - Distance of sprayed line
 - Gallons Pumped
 - Job Mil and Live Mil
 - Speed
 - Pressure
 - Input Line Width

MEASURE MODE

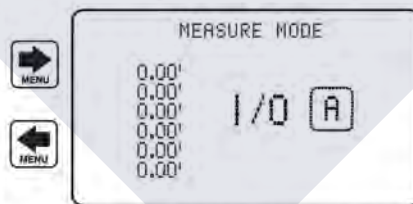

- Take up to 6 measurements by pressing the **A** button to start the measurement and pressing it again to end the measurement.

SETTING/INFO

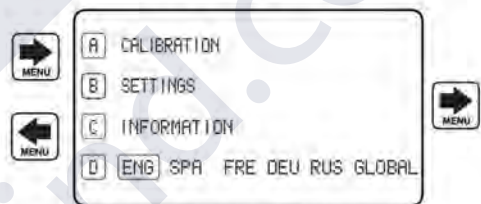

- Settings and information can be accessed from this screen.
- For accurate distance calculations, the machine must be calibrated. Press **A** to calibrate the machine. Use a distance of at least 25 feet or more.

Initial Setup (ES 2000 Standard Series)

The initial setup prepares the striper for operation based on a number of user entered parameters. Language selections and the units of measure selections can be set before you start or changed later.

Language

From Setup/Information select appropriate language by pressing **D** until the language is outlined.



ENG = English
 SPA = Spanish
 FRE = French
 DEU = German
 RUS = Russian
 WORLD = Symbols; see **World Key Symbol**, page 115.

NOTE: Language can be changed later.

Units

Press **B** to enter settings and then **B** again to enter units. Select appropriate units of measure.



US Units

Pressure = psi
 Volume = gallons
 Distance = feet
 Line Thickness = mil

SI Units

Pressure = bar (MPa available)
 Volume = liters
 Distance = meters
 Line thickness = micron (g/m² available)

Paint Specific Gravity = Use UP and DOWN arrows to set specific gravity. Required to determine paint thickness.

NOTE: All units can be changed individually at any time.

Calibration

1. Check rear tire pressure 55 ± 5 psi (379 ± 34 kpa) and fill if necessary.
2. Extend steel tape to distance greater than 26 ft. (8m).

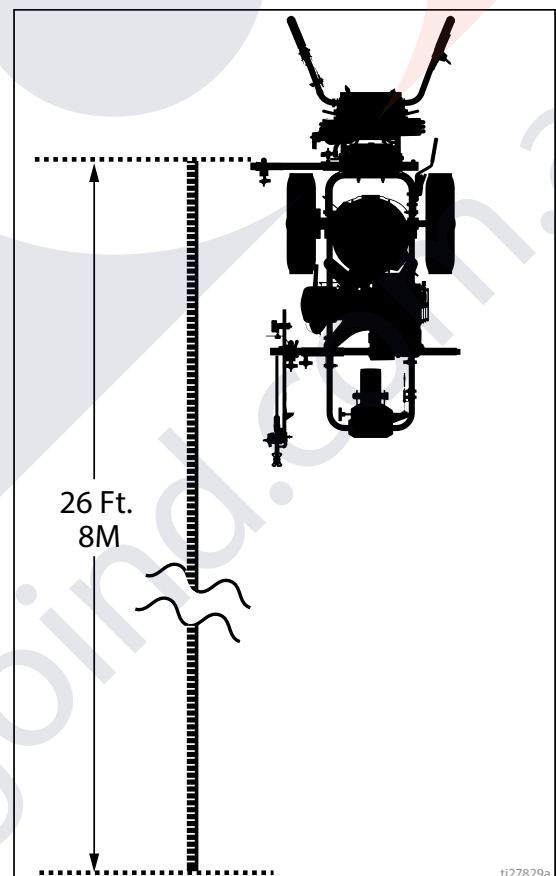

3. Press to select Setup/Information.



4. Press for Calibration. Set TRAVEL DIST to 25 ft (7.6m) or longer. Longer distances ensure better accuracy, depending on conditions.

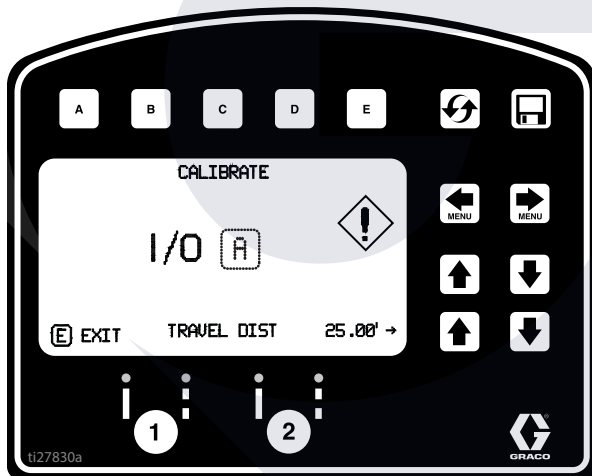

5. Align part of the unit with 1 foot (30.5cm) on steel tape.

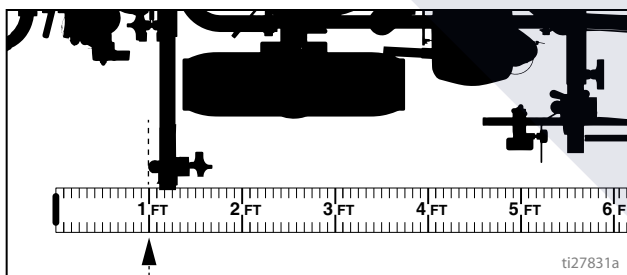

6. Push to start calibration.

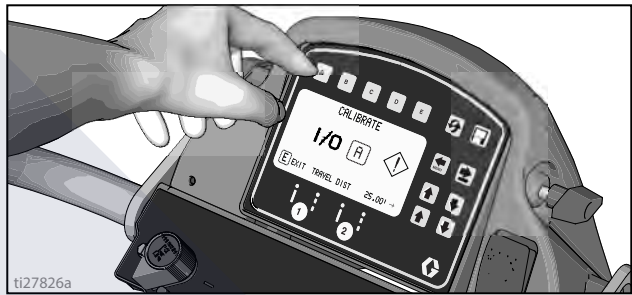

7. Move striper forward. Keep unit aligned with steel tape.
8. Stop when chosen part of unit aligns with 26-ft (8m), or distance entered, on steel tape (25-ft./ 7.6m distance).

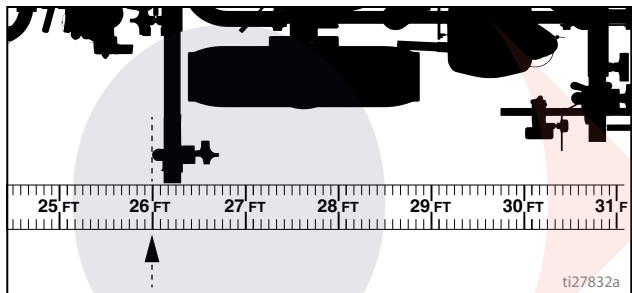

9. Push to complete calibration.

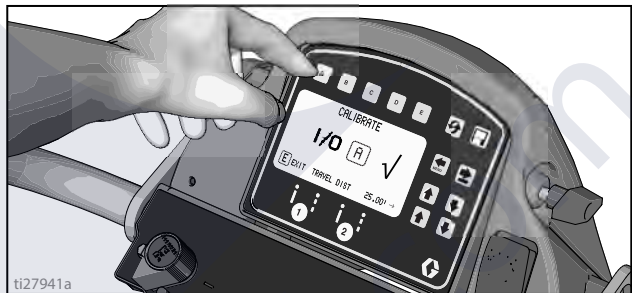

- Calibration is not complete when the exclamation symbol is displayed.
- Calibration is finished when the check mark symbol is displayed.

10. Calibration is now complete.

Go to **Measure Mode (ES 2000 Standard Series)**, page 34, and verify accuracy by measuring the tape.

Striping Mode (ES2000 Standard Series)

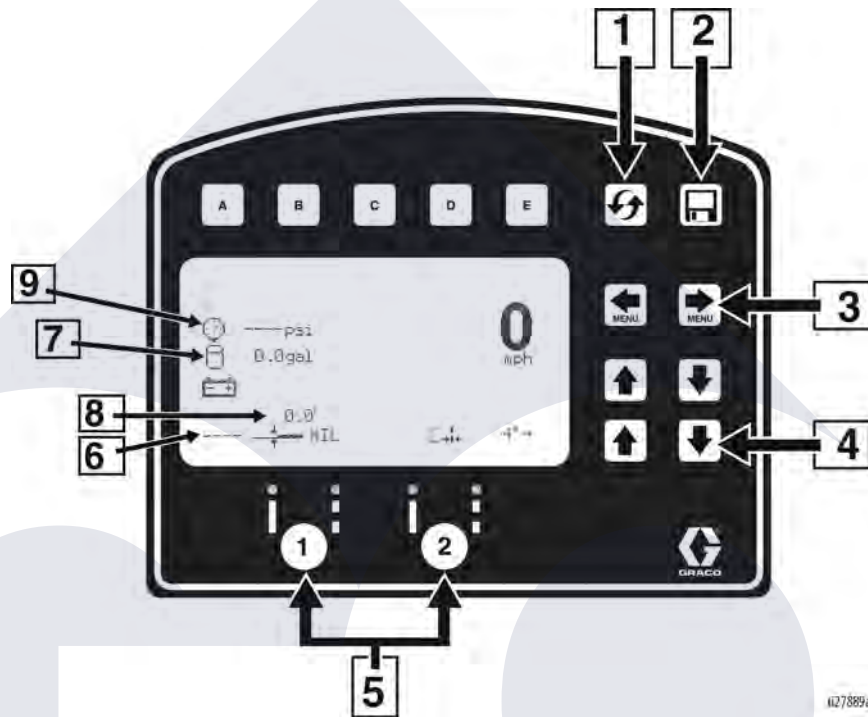

ti27889a

Ref.	Description
1	Resets Distance, Gallons, Mils
*2	Job logging
3	Scroll between menu screens
4	Line width adjustment buttons
*5	Auto gun buttons
6	MIL thickness. While spraying "Instant MIL avg" is displayed. When stopped total "Job MIL avg" is displayed.
7	Total gallons sprayed
8	Total line length sprayed.
9	Pressure

* Not active in Standard Series. Upgrade to HP Auto Series with P/N 25N711.

Operating in Striping Mode

1. Make sure ON/OFF switch is ON position.
2. Set pump switch to ON.

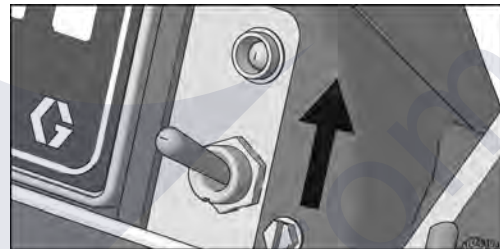

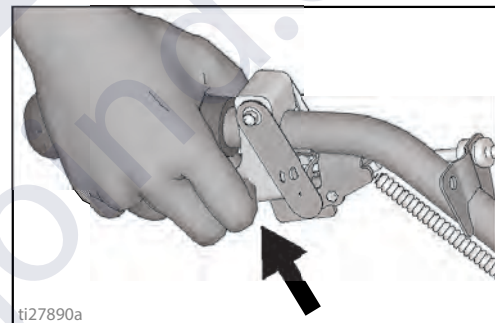

3. Pull trigger to spray.



ti27890a

Measure Mode (ES 2000 Standard Series)

Measure Mode replaces a tape measure to measure distances when laying out an area to be striped.

1. Use   to select Measure Mode.

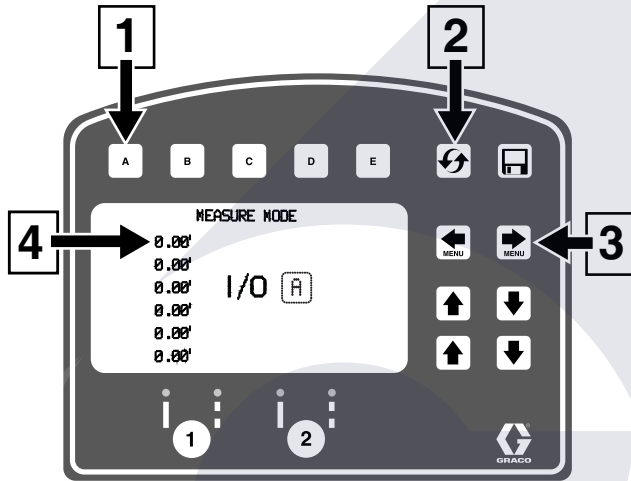

ti27834a

Ref.	Description
1	Press to start measurement, Press to stop measurement
2	Hold to reset values to zero
3	Scroll between main menu screens
4	Last measurement taken



2. Press and release **A**. Move striper forwards or backwards. (Moving backwards is a negative distance.)



3. Press and release **A** to end measured length. Up to six lengths are viewable.



Setup/Information

Use   to select Setup/Information.



Press **D** to select Language.
See **Language**, page 31.

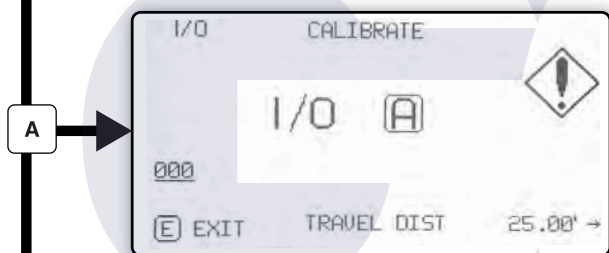

See **Calibration**, page 31.

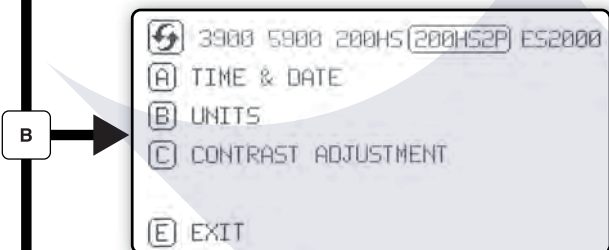

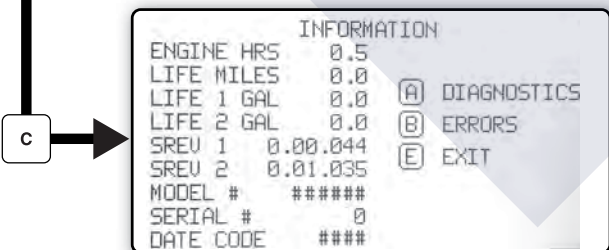

See **Settings**, page 36.



See **Information**, page 37.

ti27835b



Settings

Use   to select Setup/Information. Press  to open Settings Menu.

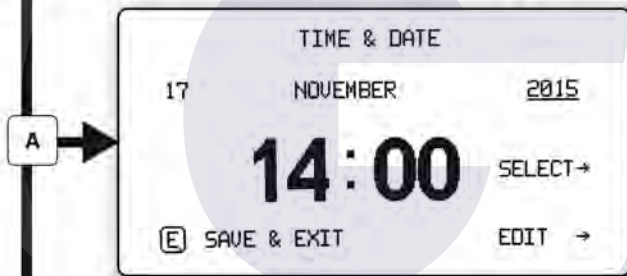

 Chooses the machine type. Necessary for accurate gallon counting.



Use   to set time and date.

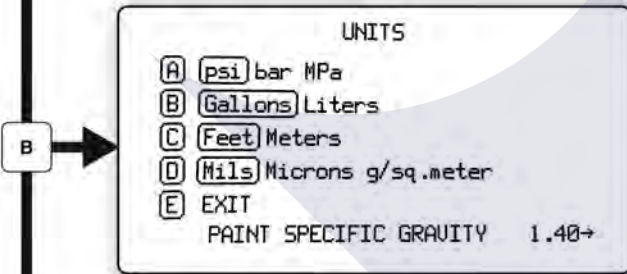

Set units with    

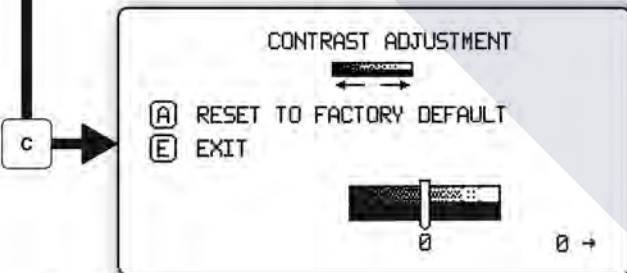

Use   to adjust screen contrast to the desired value.

Information

Use to select Setup/Information. Press to open Information Menu.



Displays and logs life data and stripper information.

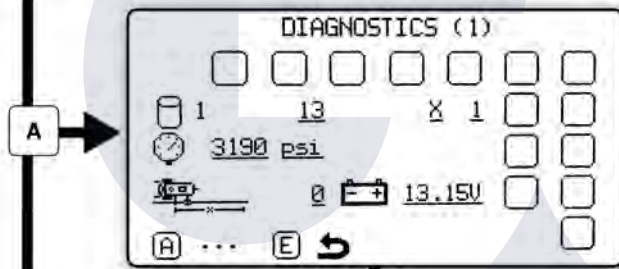

View and test functionality of components.

- Stroke Counter
- Pressure Transducer
- Distance Sensor
- Touch Pad Buttons
- Battery Voltage

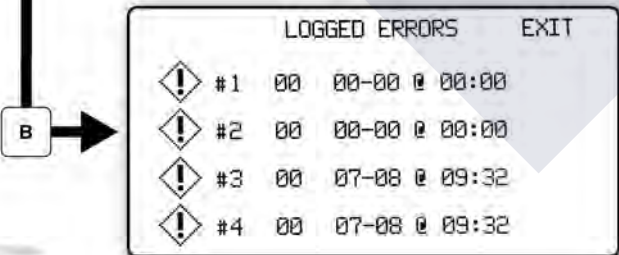
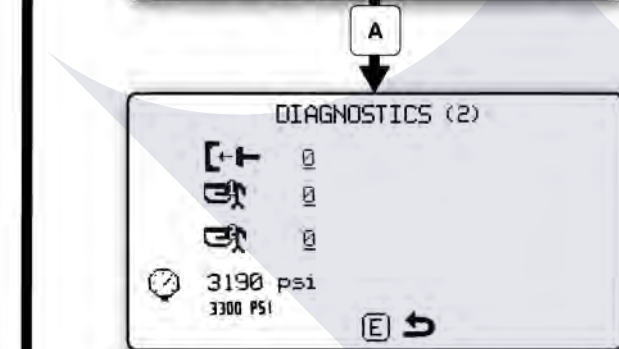

Logs last four error codes that occurred.

- Code Description
- 02 = Over pressure
- 03 = No transducer detected

Reset error codes

ES2000 (HP Auto Series)

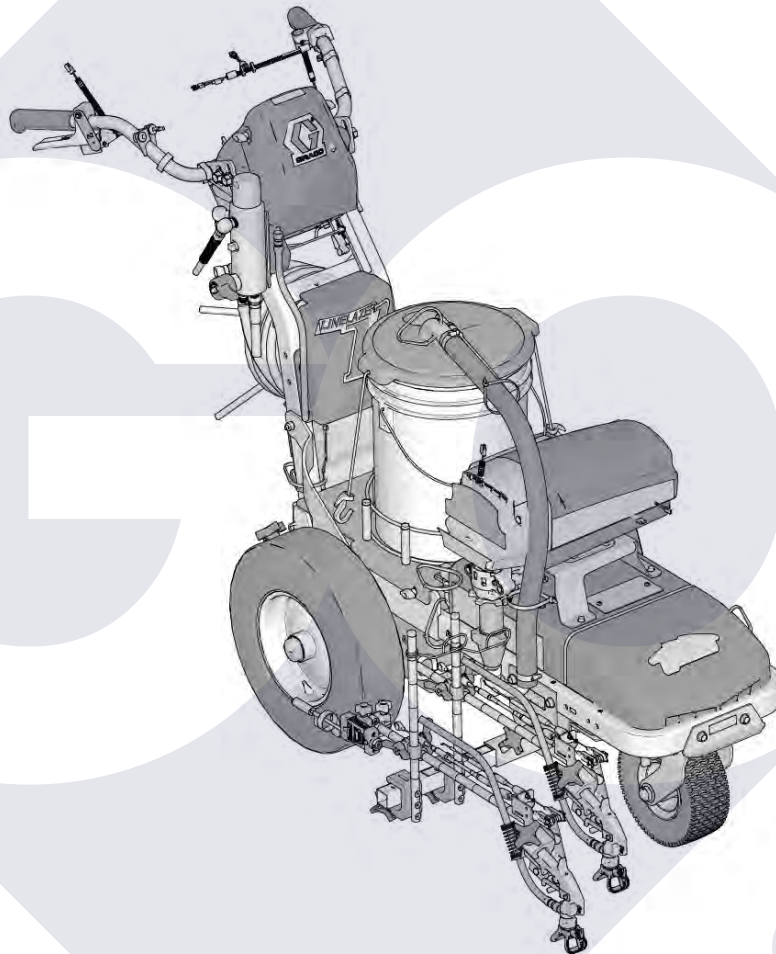

LineLazer V LiveLook Display

ES2000 (HP Auto Series)

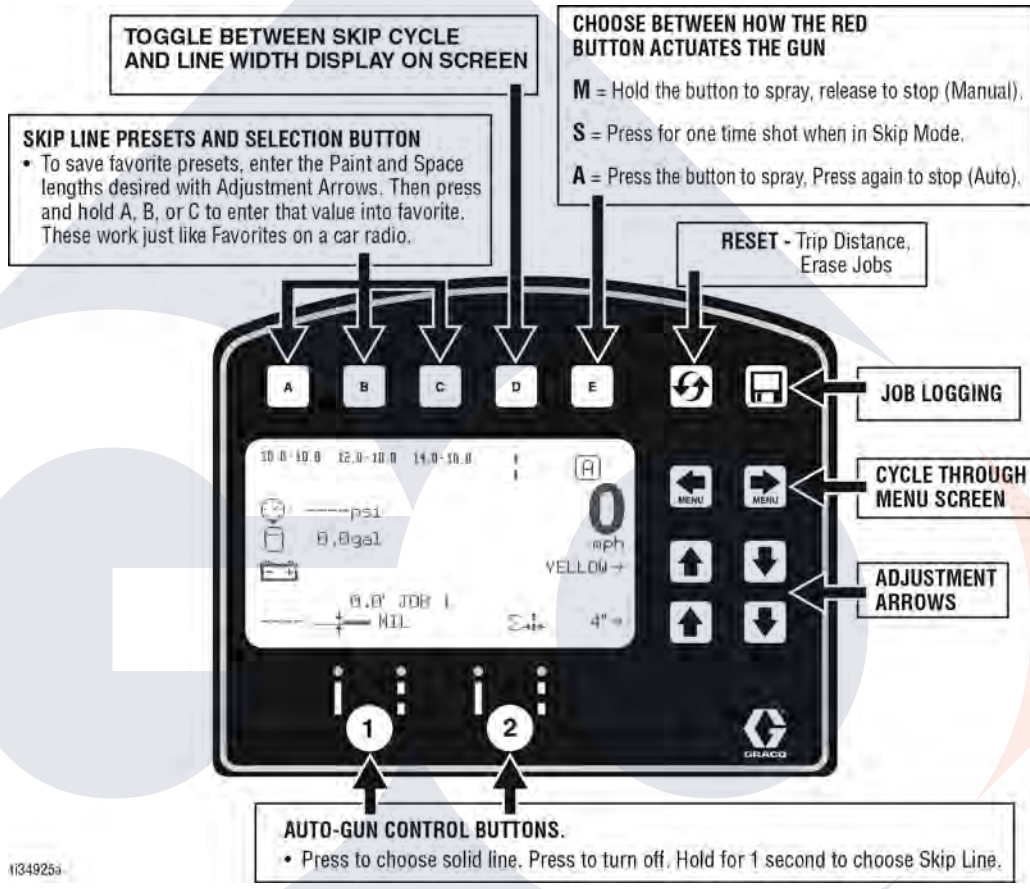

1134925a

STRIPING SCREEN	MEASURE MODE	LAYOUT MODE	SETTING/INFO
<ul style="list-style-type: none"> Main stripping screen. Must be in this mode to electronically actuate guns. Automatic Skip Cycles can be laid from this screen. Choose skip line on the desired gun to fire. Enter the Paint and Space distance wanted and begin spraying. Press the E Button to choose how the red button actuates the guns. <p>M = Hold to spray, release to stop S = Press for one time shot when in Skip Mode. A = Press to start, press to stop</p>	<ul style="list-style-type: none"> Measure Mode. Ability to take up to 6 measurements by pressing the red button to start the measurement and pressing it again to end the measurement. If an Auto Gun is selected (see below) and the red button is held down, a dot will be dropped every 12" until the red button is released. 	<ul style="list-style-type: none"> Layout Mode. Drop a dot at a chosen distance to layout a parking lot. Enter stall size, activate an auto gun, press the red button, and roll the machine. To stop dotting, press the red button again. Favorites can be saved just like in the main screen. <p>A STALL CALCULATOR see page 45 B ANGLE CALCULATOR see page 46</p>	<ul style="list-style-type: none"> Settings and Information can be accessed from this screen. For accurate distance calculations the machine must be calibrated. Press A to calibrate the machine. Use a distance of at least 25' or more.

Initial Setup (ES2000 HP Auto Series)

The initial setup prepares the striper for operation based on a number of user entered parameters. Language selections and the units of measure selections can be set before you start or changed later.

Language

From Setup/Information select appropriate language by pressing **[D]** until the language is outlined.



ENG = English
 SPA = Spanish
 FRE = French
 DEU = German
 RUS = Russian
 WORLD = Symbols see **World Key Symbol**, page 115.

NOTE: Language can be changed later.

Units

Press **[B]** to enter settings and then **[B]** again to enter units. Select appropriate units of measure.



US Units

Pressure = psi
 Volume = gallons
 Distance = feet
 Line Thickness = mil

SI Units

Pressure = bar (MPa available)
 Volume = liters
 Distance = meters
 Line thickness = micron (g/m² available)



Paint Specific Gravity = Use UP and DOWN arrows to set specific gravity. Required to determine paint thickness.

NOTE: All units can be changed individually at any time.

Calibration

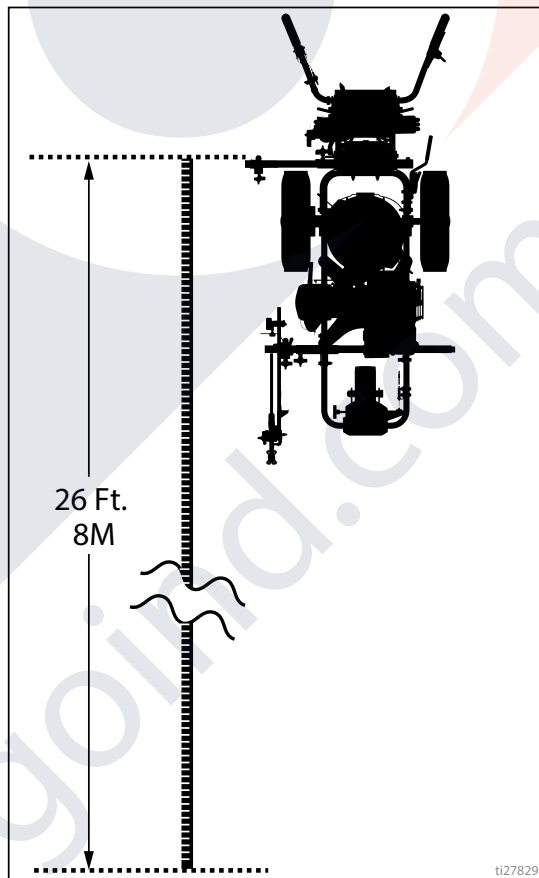
1. Check rear tire pressure 55 ± 5 psi (379 ± 34 kpa) and fill if necessary.
2. Extend steel tape to distance greater than 26 ft. (8m).



- Press   to select Setup/Information.



- Press **A** for Calibration. Set TRAVEL DIST to 25 ft (7.6m) or longer. Longer distances ensure better accuracy, depending on conditions.

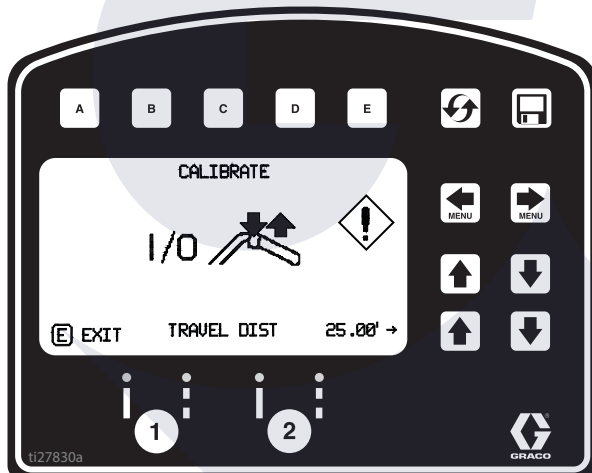

- Turn on laser and align laser dot with 1 foot (30.5cm) on steel tape.

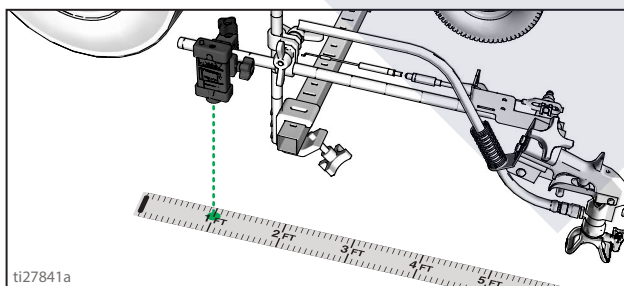

- Press and release gun trigger control to start calibration.

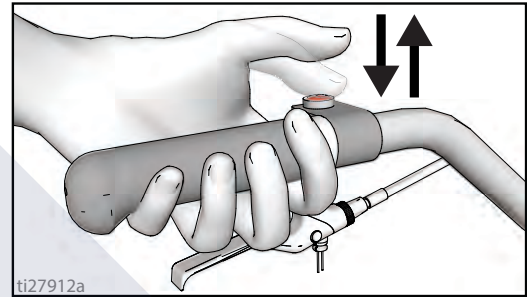

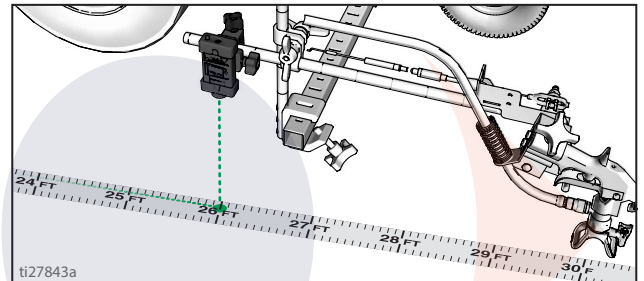

- Move striper forward. Keep laser dot on steel tape.
- Stop when laser aligns with 26-ft (8m) or distance entered on steel tape (25-ft./7.6m distance).

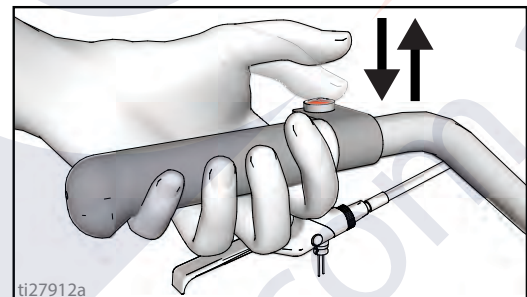

- Press and release gun trigger control to complete calibration.



- Calibration is not complete when the exclamation symbol  is displayed.
- Calibration is finished when the check mark symbol  is displayed.

- Calibration is now complete.

Striping Mode (ES2000 HP Auto Series)

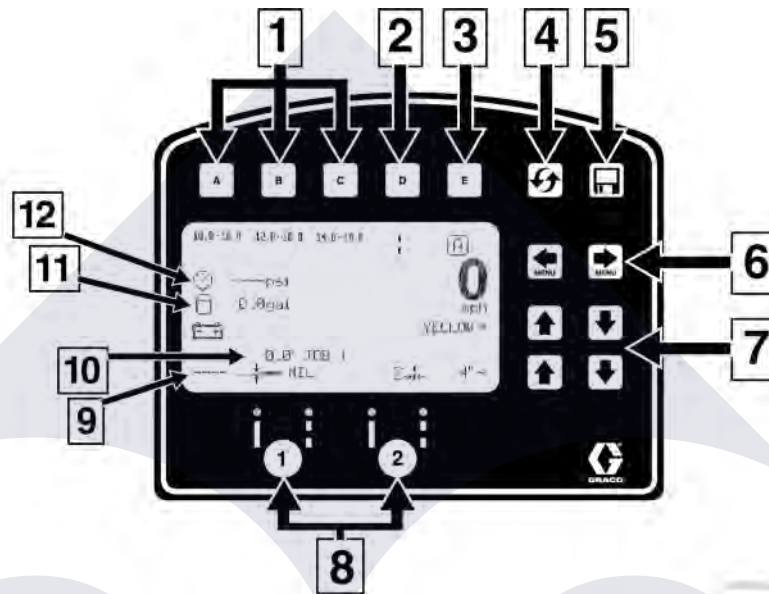

Ref.	Description
1	Select a “Favorite”, press for less than one second. Save a “Favorite”, press and hold for more than three seconds.
2	Cycles between viewing line width or paint and space value.
3	Cycles between Manual Mode, Semi-Automatic Mode, Automatic Mode. Manual Mode [M] : Press and hold gun trigger control to stripe.
	Semi-Automatic Mode [S] : Press and release gun trigger control to stripe the programmed length one time when in Skip Mode.
	Automatic Mode [A] : Press and release gun trigger control to start striping. Press and release button again to stop.
4	Resets trip distance.
5	Job Data Logger, page 52.
6	Scrolls between menu screens.
7	Paint and Space length OR line width adjustment buttons.
8	Auto guns activation buttons.
9	MIL thickness. While spraying “Instant MIL avg” is displayed. When stopped total “Job MIL avg” is displayed.
10	Total gallons (liters) sprayed.
11	Total line length sprayed.
12	Pressure

Operating in Striping Mode

Striper must be running before activating gun trigger control.

1. Make sure ON/OFF switch is ON position.
2. Use gun activation buttons to select guns and line type.



3. Press gun trigger control to begin spraying.

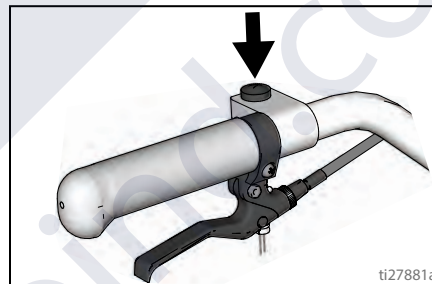

In Automatic Mode or Semi-Automatic Mode the **[A]** or **[S]** will flash when gun trigger control is pressed to signal mode is active.

Measure Mode (ES2000 HP Auto Series)

Measure Mode replaces a tape measure to measure distances when laying out an area to be striped.

1. Use to select Measure Mode.

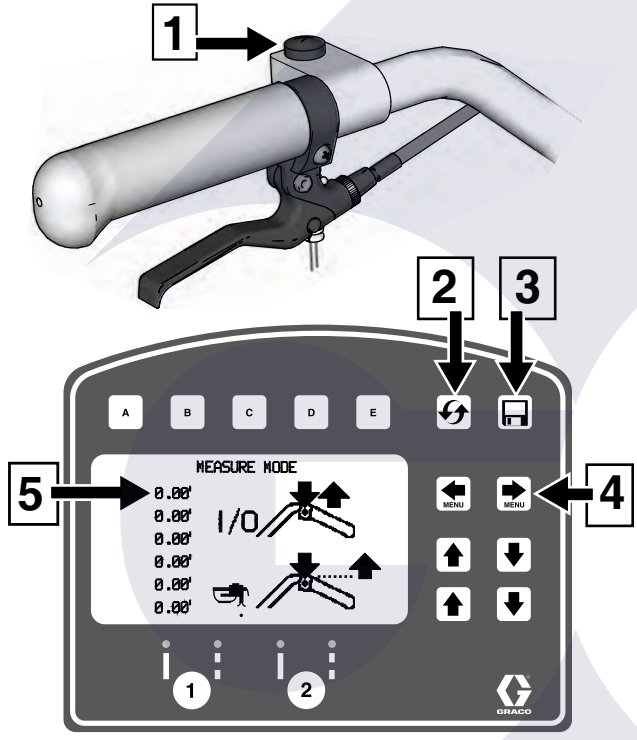

2. Press and release gun trigger control. Move striper forwards or backwards. (Moving backwards is a negative distance.)

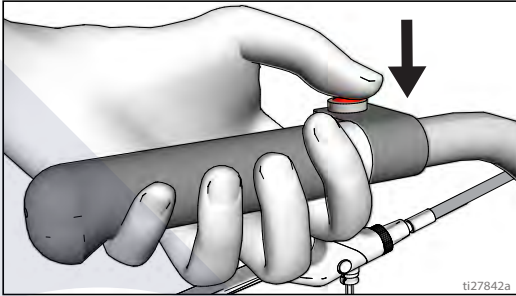

3. Press and release gun trigger control to end measured length. Up to six lengths are viewable.

The most recent measured length is also saved as the measured distance in the Stall Calculator display. See **Stall Calculator**, page 45.

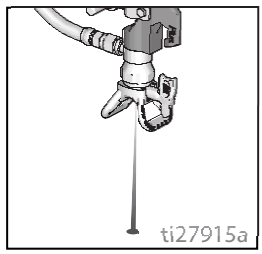
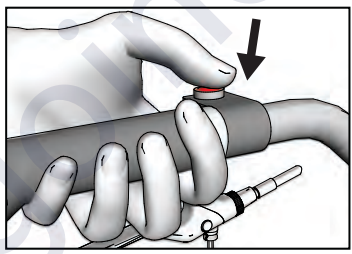
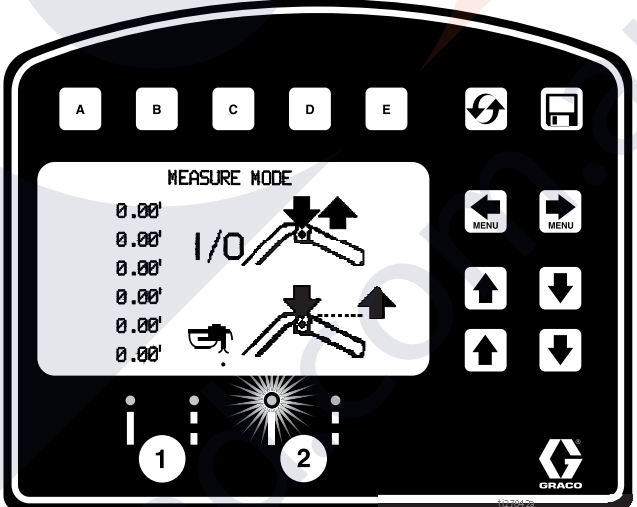

If an auto gun is activated, press and hold gun trigger control at any time to apply a dot. If trigger is held while striper is moving, a dot is marked every 12-inches (30.5cm).

Ref.	Description
1	Press to start measurement, Press to stop measurement.
2	Hold to reset values to zero.
3	Job Data Logger, page 52.
4	Scroll between main menu screens
5	Last measurement taken



Layout Mode

Layout Mode is used to calculate and mark parking lot stalls.

1. Use   to select Layout Mode.

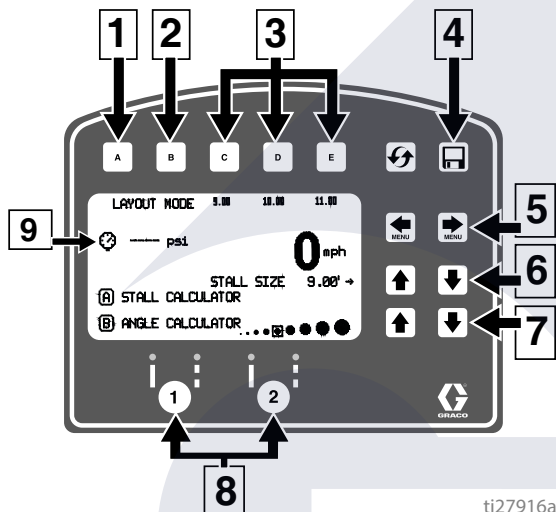

Ref.	Description
1	Opens Stall Calculator Menu. See Stall Calculator , page 45.
2	Opens Angle Calculator Menu. See Angle Calculator , page 46.
3	Select a "Favorite", press for less than one second. Save a "Favorite", press and hold for more than three seconds.
4	Job Data Logging, page 52.
5	Scroll between menu screens.
6	Adjust stall size/dot spacing.
7	Adjust dot size.
8	Auto Gun activation buttons.
9	Pressure.

2. Use gun activation buttons to select guns.

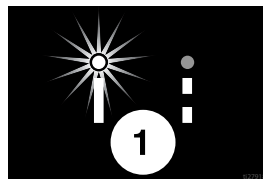

3. Press and release gun trigger control and move striper forward.

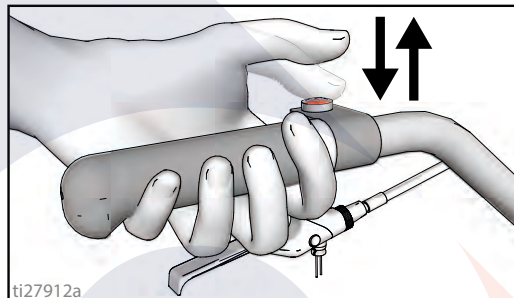

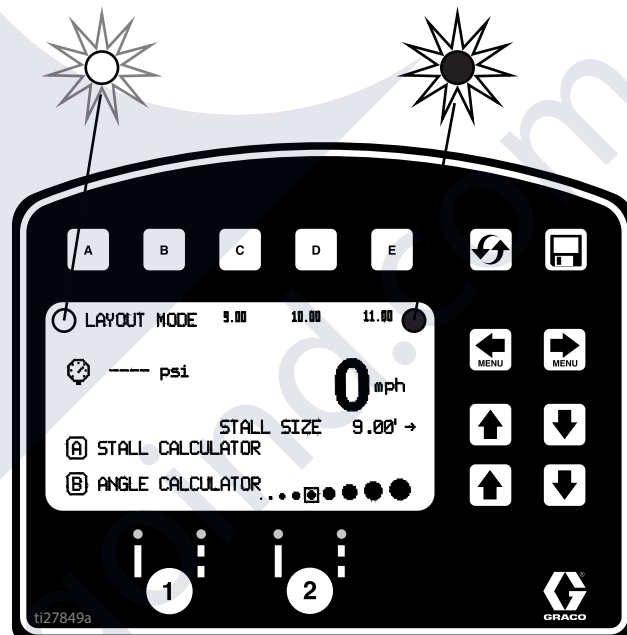

4. Striper default is to place a dot every 9.0 ft (2.7m) to mark the stall size. Stall size is adjustable.
5. Dots are laid down until gun trigger control is pressed and released again.

An indicator on the screen alternately flash when gun trigger control is pressed to signal mode is active.



Stall Calculator

Stall Calculator is used to set the stall size. The striper divides the measured length by the stall size to determine the number of stalls that will fit in the length measured. User can adjust number of stalls to a round number and stall width is calculated.



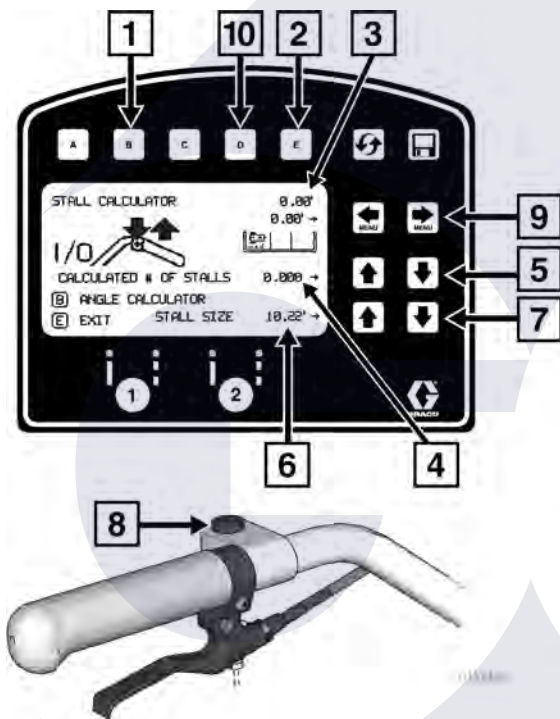

- Use   to select Layout Mode. Press **A** to open Stall Calculator Menu.



Ref.	Description
1	Opens Angle Calculator Menu. See Angle Calculator , page 46.
2	Exits and returns stall size to Layout Mode.
3	Measured distance.
4	Calculated # of stalls. Changing the number of stalls will change the stall size.
5	Adjusts number of stalls.
6	Stall size. Changing stall size changes the calculated # of stalls.
7	Adjusts stall size.
8	Press to start measurement, Press to stop measurement.
9	Adjust Offset (x).
10	Stores Offset (x). Hold for 2 seconds to store value.

- The most recent length measured in Measure Mode is automatically displayed. Press gun trigger control to start a new measurement. Press again to stop measuring.

When measuring between curbs, the distance from the back tire/curb to the gun/laser dot, can be accounted for by setting the Offset (x) value.

- Back the striper up to the curb, then use a tape measure to measure from where the tire touches the curb to the laser dot on the ground.
- Use   to enter the offset (x) value.
- This value can be stored by holding **D** for 2 seconds.
- The value stored under **D** can be added to the measured distance before or after the measurement is taken between the curbs.
- The offset (x) value can also be adjusted before or after the measurement is taken by using  .

Stall size and calculated number of stalls are both adjustable.

- Press **E** to return to Layout Mode. The Stall size is saved and displayed on the Layout Mode screen.

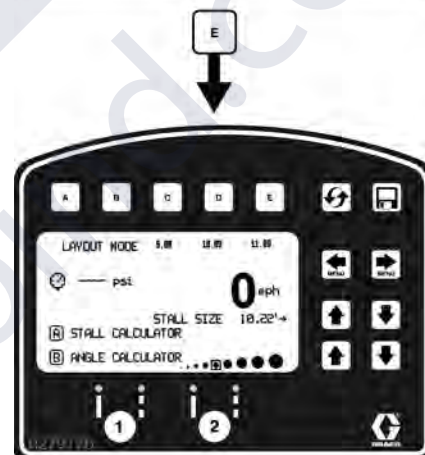
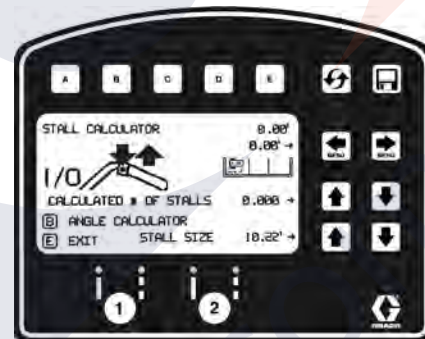

- Press and release gun trigger control to start marking dots. Press and release gun trigger control again to stop.

Angle Calculator

Angle Calculator is used to determine the offset value and dot spacing value for a layout.

- Use to select Layout Mode. Press **B** to open Angle Calculator Menu.

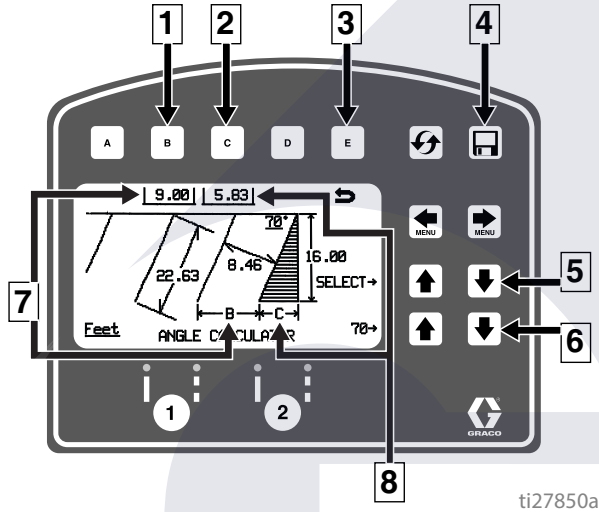

ti27850a

Ref.	Description
1	Transfers calculated dot spacing, B, to Layout Mode.
2	Transfers calculated off set, C, to Layout Mode.
3	Exits and returns to Layout Mode without transferring any values.
4	Data Logging.
5	Select input variables.
6	Adjust the variable selected.
7	Calculated dot spacing, B.
8	Calculated off set, C.

- Dot spacing (B) and offset (C) are calculated based on the parameters entered:

Stall angle
 Stall depth
 Stall size (width)
 Line Length

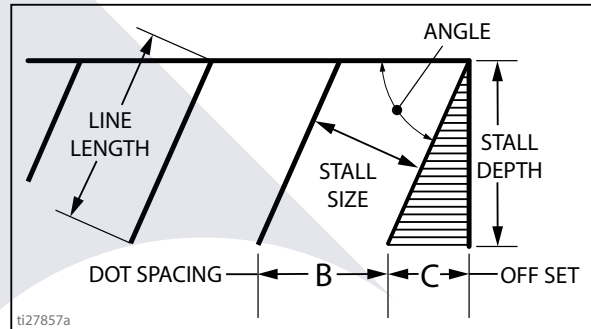

ti27857a

- Press **C** to transfer calculated off set distance to Layout Mode. Save this value in favorites if desired.

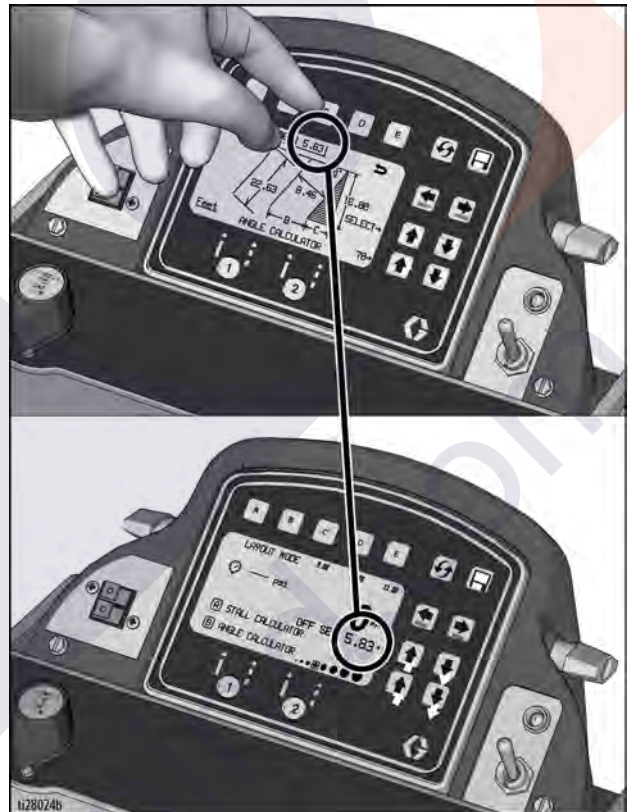

ti28024b

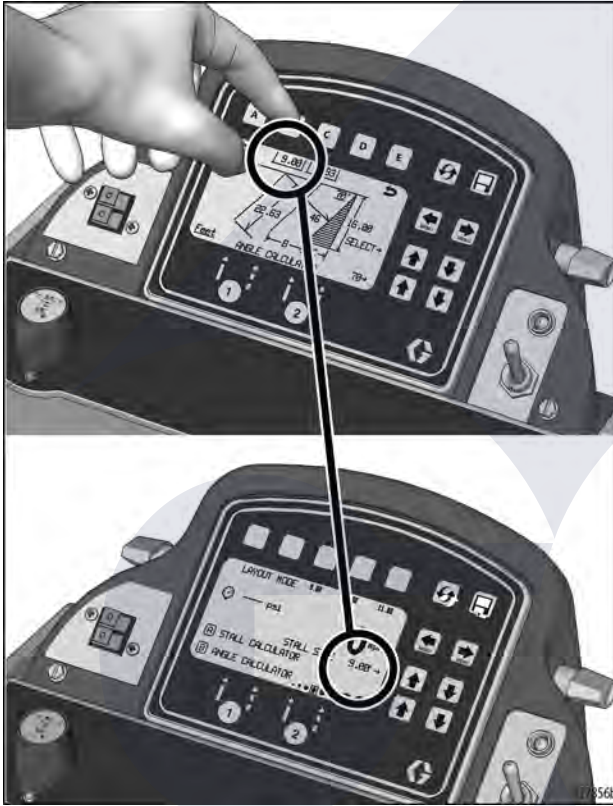

4. Press **B** to transfer calculated dot spacing distance to Layout Mode. Save this value in favorites if desired.

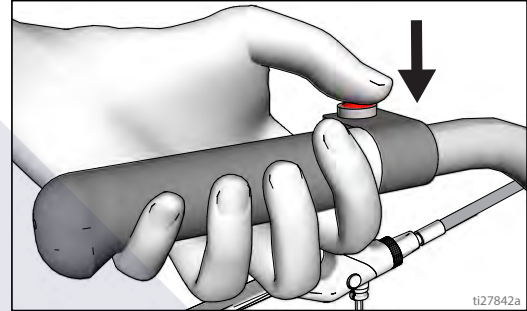

5. Press and release gun trigger control to start marking stall size dots. Press and release gun trigger control to stop marking.



Setup/Information

Use   to select Setup/Information.



Press **D** to select Language.
See **Language**, page 31.

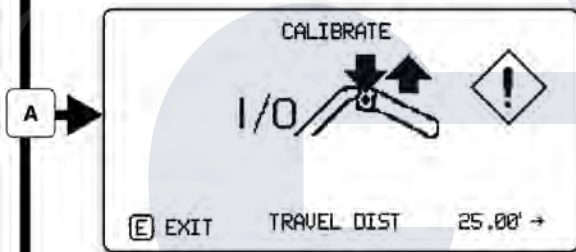

See **Calibration**, page 31.



See **Settings**, page 49.

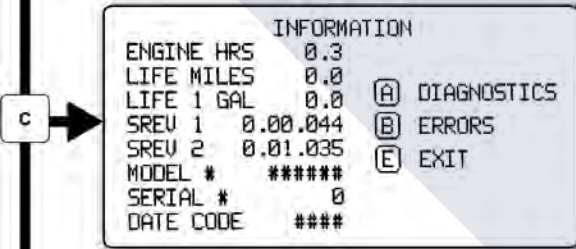

See **Information**, page 50.

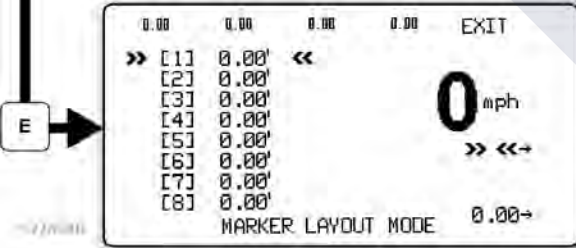

See **Marker Layout Mode**, page 51.

Settings

Use to select Setup/Information. Press to open Settings Menu.



Chooses the machine type. Necessary for accurate gallon counting.

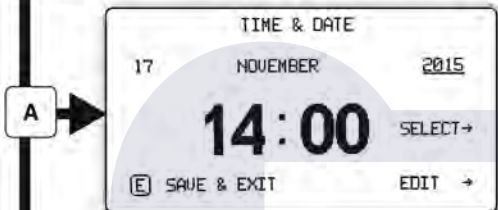

Use to set time and date. Needed for accurate Data Logging.

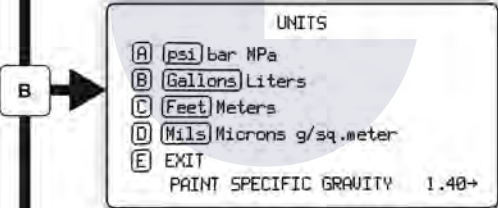

Set units with

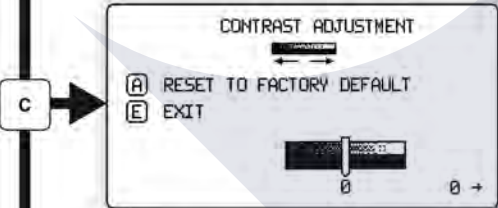

Use to adjust screen contrast to the desired value.

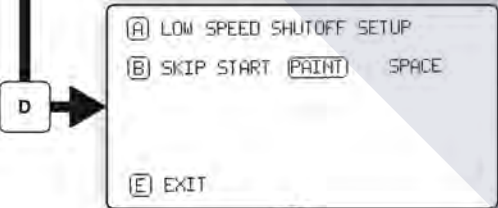

For programmed skip lines, press to choose:

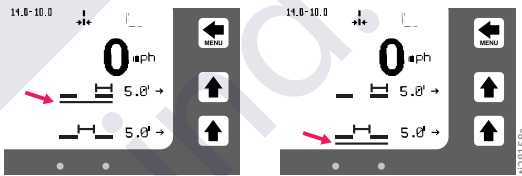

In Auto-mode, guns won't fire or will shut off if speed is below set value.

Enable or Disable Low Speed Shutoff

Adjust low speed setting.

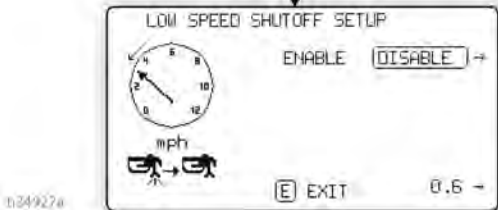

Information

Use to select Setup/Information. Press to open Information Menu.



Displays and logs life data and striper information.

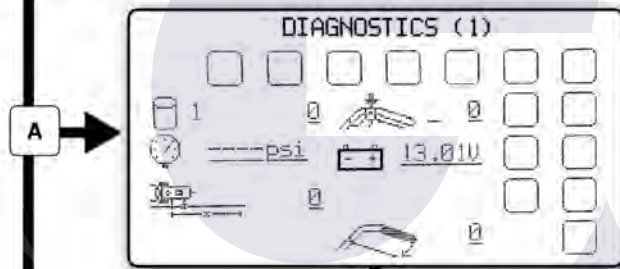

View and test functionality of component

- Stroke Counter
- Pressure Transducer
- Distance Sensor
- Touch Pad Buttons
- Battery Voltage

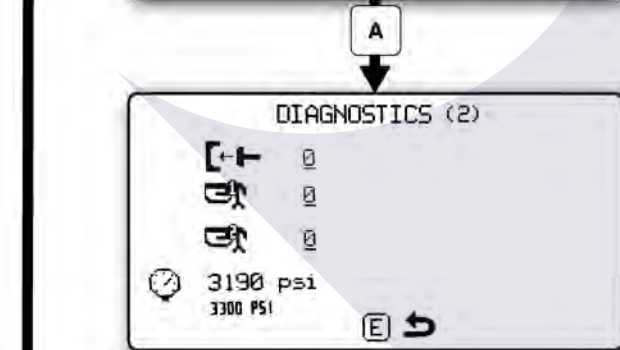

Logs last four error codes that occurred.

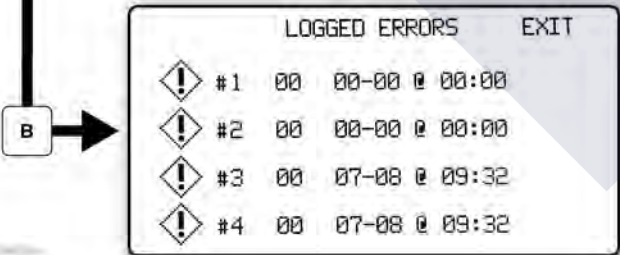

- Code Description
- 02 = Over pressure
- 03 = No transducer detected

- Reset error codes

Marker Layout Mode

The Marker Layout Mode feature sprays a dot or a series of dots to mark an area.

1. Use to select Setup/Information. Press to open Marker Layout Mode.

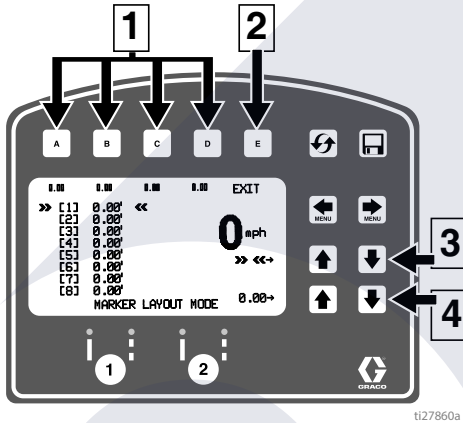

4. Set gun switch to skip line or solid line.

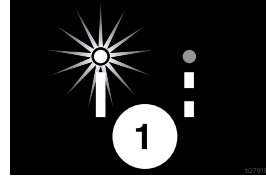

5. Press and release gun trigger control to start marking dots. Press and release gun trigger control again to stop.

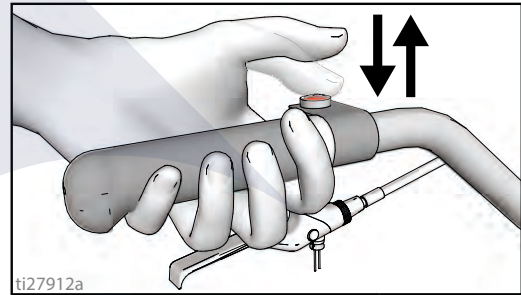

Ref.	Description
1	Select a "Favorite", press for less than one second.
	Save a "Favorite", press and hold for more than three seconds.
2	Exits and returns to Information Menu.
3	Select value to change.
4	Adjust spacing value.

2. Use arrow keys to set up a marker pattern.
3. Marker layout example shows a typical lane layout for reflective markers. Set space sizes up to eight consecutive measurements. By leaving zeros in any space, Marker Layout Mode will skip to the next measurement in a continuous loop.

Some other uses of Marker Layout Mode are:

- Multiple spaced handicap stall layout
- Double line stalls

An indicator before and after Marker Mode on the screen alternately flash when gun trigger control is pressed to signal mode is active.

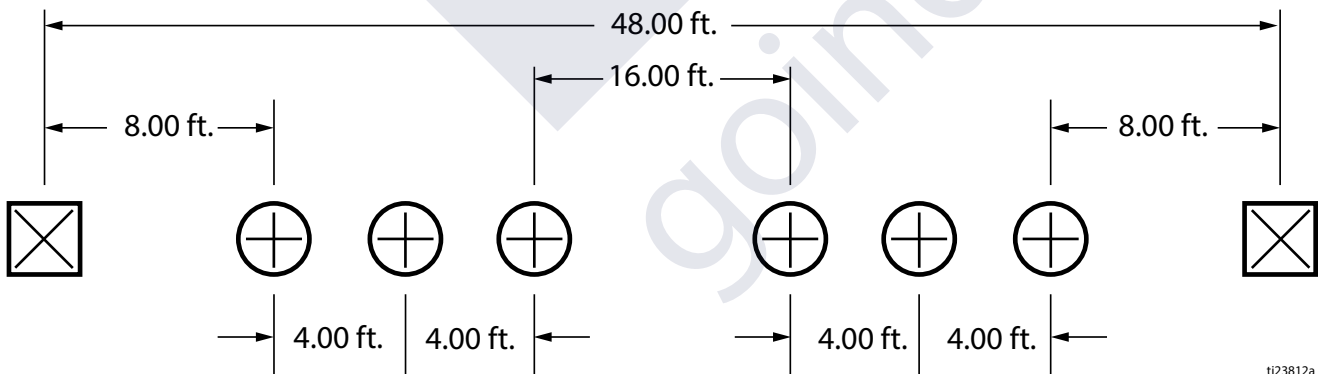
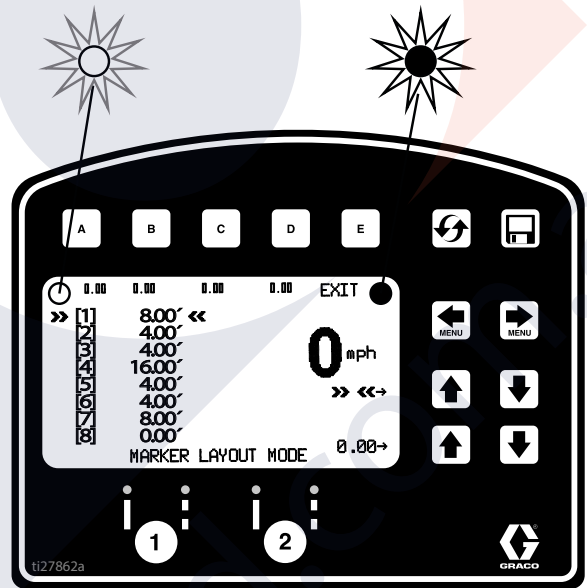

Data Logging

The LLV control is equipped with Data Logging, which allows the user to recall job data and export the data from the machine to a USB drive.

1. Press the  to open the Data Logging pop up window.
2. Choose to start recording a new job or view jobs previously done.

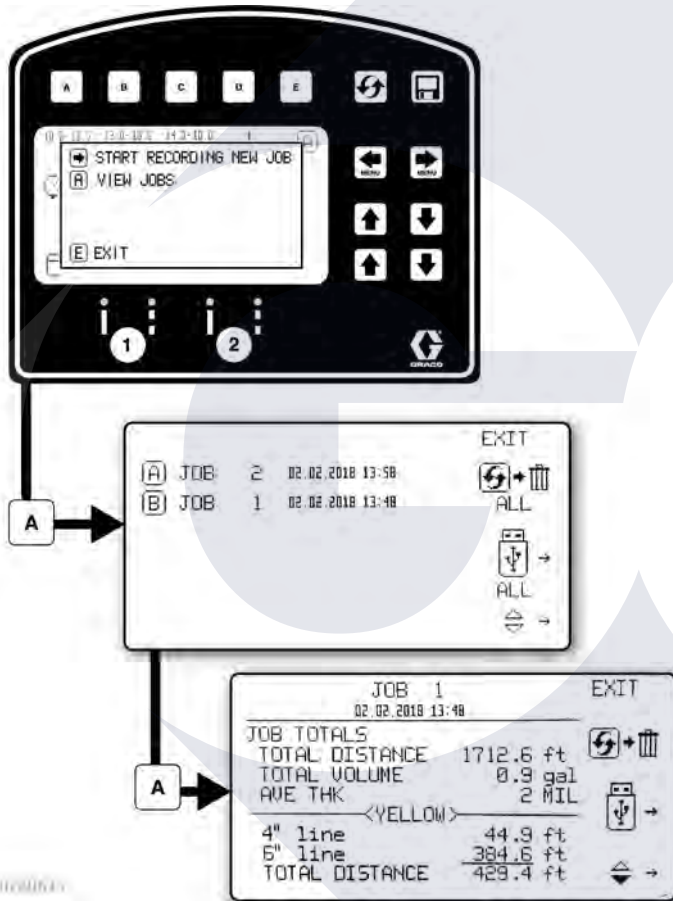

 Start recording a new job.

 Erase all jobs

 Export all jobs to USB

 Erase jobs

 Export job to USB

Job data is compiled while spraying. A summary of volume sprayed, distance sprayed and average mil thickness is displayed for the entire job. The job is also broken down by colors, line widths and stencil volume sprayed.

Maintenance

Routine maintenance is important to ensure proper operation of your sprayer. Maintenance includes performing routine actions which keep your sprayer in operation and prevents trouble in the future.



Activity	Interval
Inspect/clean sprayer filter, fluid inlet strainer, and gun filter.	Daily or each time you spray
Inspect motor shield vents for blockage.	Daily or each time you spray
Fill TSL by adding through TSL fill point.	Daily or each time you spray
Check hose for wear and damage.	Daily or each time you spray
Check gun safety for proper operation.	Daily or each time you spray
Check drain valve for proper operation.	Daily or each time you spray
Verify calibration.	Daily or each time you spray
Tighten nut under dust cover on front caster until spring washer bottoms out, then back off the nut 1/2 to 3/4 turn.	Once per year or as needed
Grease wheel bearings.	Once per month
Check caster wheel alignment.	Daily or each time you spray
Check sprayer stall. With sprayer gun NOT triggered, sprayer motor should stall and not restart until gun is triggered again. If sprayer starts again with gun NOT triggered, inspect pump for internal/external leaks and check prime valve for leaks.	Every 1000 gallons (3785 liters)
Throat packing adjustment When pump packing begins to leak after extended use, tighten packing nut down until leakage stops or lessens. This allows approximately 100 gallons of additional operation before a repacking is required. Packing nut can be tightened without O-ring removal.	As necessary based on usage

Recycling and Disposal

Rechargeable Battery Disposal

Do not place batteries in the trash. Recycle batteries according to local regulations. In the USA and Canada, call 1-800-822-8837 to find recycling locations or go to www.call2recycle.org.



End of Product Life

At the end of the product's useful life, dismantle and recycle it in a responsible manner.

- Perform the **Pressure Relief Procedure**.
- Drain and dispose of fluids according to applicable regulations. Refer to the material manufacturer's Safety Data Sheet.
- Remove motors, batteries, circuit boards, LCDs (liquid crystal displays), and other electronic components. Recycle according to applicable regulations.
- Do not dispose of batteries or electronic components with household or commercial waste.

- Deliver remaining product to a recycling facility.

goind.com.au

Troubleshooting (ES 1000 & ES 2000)

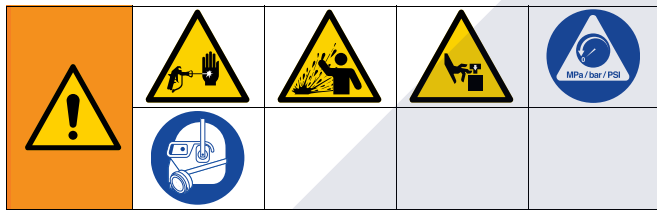
Mechanical/Fluid Flow



1. Follow **Pressure Relief Procedure**, page 16, before checking or repairing.
2. Check all possible problems and causes before disassembling the unit.

Problem	What to Check If check is OK, go to next check	What to Do When check is not OK, refer to this column
Control board status light is blinking or the light is off and there is power to the sprayer.	Fault condition exists.	Determine fault correction from page 63. Follow Pressure Relief Procedure , page 16.
Pump output is low	Spray tip worn.	Follow Pressure Relief Procedure , page 16, then replace tip. See separate gun or tip manual.
	Spray tip clogged.	Follow Pressure Relief Procedure , page 16. Check and clean spray tip.
	Paint supply.	Refill and reprime pump.
	Intake strainer clogged.	Remove and clean, then reinstall.
	Intake valve ball and piston ball are not seating properly.	Remove intake valve and clean. Check balls and seats for nicks; replace if necessary. See pump manual. Strain paint before using to remove particles that could clog pump.
	Fluid filter or tip filter is clogged or dirty.	Clean filter.
	Prime valve leaking.	Follow Pressure Relief Procedure , page 16, then repair prime valve.
	Verify pump does not continue to stroke when gun trigger is released. (Prime valve not leaking.)	Service pump. See pump manual.
	Leaking around throat packing nut which may indicate worn or damaged packings.	Replace packings. See pump manual. Also check piston valve seat for hardened paint or nicks and replace if necessary. Tighten packing nut/wet-cup.
	Pump rod damage.	Repair pump. See pump manual.
	Low stall pressure.	Turn pressure knob fully clockwise. Make sure pressure control knob is properly installed to allow full clockwise position. If problem persists, replace pressure transducer.
	Piston packings are worn or damaged.	Replace packings. See pump manual.
	O-ring in pump is worn or damaged.	Replace o-ring. See pump manual.
	Intake valve ball is packed with material.	Clean intake valve. See pump manual.
Large pressure drop in hose with heavy materials.	Reduce overall length of hose.	
Check extension cord for correct size.	See 230V units require 230 VAC, 50/60 Hz, 7 or 9A, 1 phase. , page 14.	

Problem	What to Check If check is OK, go to next check	What to Do When check is not OK, refer to this column
Motor runs but pump does not stroke	Connecting rod assembly damaged.	Replace connecting rod assembly. See pump manual.
	Gears or drive housing damaged.	Inspect drive housing assembly and gears for damage and replace if necessary.
Excessive paint leakage into throat packing nut	Throat packing nut is loose.	Remove throat packing nut spacer. Tighten throat packing nut just enough to stop leakage.
	Throat packings are worn or damaged.	Replace packings. See pump manual.
	Displacement rod is worn or damaged.	Replace rod. See pump manual.
Fluid is spitting from gun	Air in pump or hose.	Check and tighten all fluid connections. Cycle pump as slowly as possible during priming.
	Spray tip is partially clogged.	Clear tip.
	Fluid supply is low or empty.	Refill fluid supply. Prime pump. See pump manual. Check fluid supply often to prevent running pump dry.
Pump is difficult to prime	Air in pump or hose.	Check and tighten all fluid connections. Cycle pump as slowly as possible during priming.
	Intake valve is leaking.	Clean intake valve. Be sure ball seat is not nicked or worn and that ball seats well. Reassemble valve.
	Pump packings are worn.	Replace pump packings. See pump manual.
	Paint is too thick.	Thin the paint according to supplier recommendations.
Sprayer operates for 5 to 10 minutes then stops	Pump packing nut too tight. When pump packing nut is too tight the packings on the pump rod restrict pump action and overloads the motor.	Loosen pump packing nut. Check for leaks around throat. If necessary, replace pump packings. See Pump manual.

Electrical (ES 1000)

Symptom: Sprayer does not run, stops running, or will not shut off.



<p>Keep clear of electrical and moving parts during troubleshooting procedures. To avoid electrical shock hazards when covers are removed for troubleshooting, wait five minutes after disconnecting power cord for stored electricity to dissipate.</p>				



1. Perform **Pressure Relief Procedure**, page 16.
2. Turn the ON/OFF switch **OFF** wait 30 seconds and then turn power back **ON** again (this ensures sprayer is in normal run mode).
3. Turn pressure control knob clockwise 1/2 turn.
4. Remove control box cover to view control board status light. To determine which code (or any other code besides voltage supply) refer to the control board status light. Turn the ON/OFF switch **OFF**, remove the control cover then turn power back **ON**. Observe the status light. Blinking LED total count equals the error code (for example: two blinks equals CODE 02).

Error Code Messages

CODE	MESSAGE	ACTION
02	HIGH PRESSURE DETECTED - RELIEVE PRESSURE	Check for clogs. Use only Graco spray hoses, use a minimum of 50ft/15m.
03	PRESSURE TRANSDUCER NOT DETECTED	Check transducer connection.
05	MOTOR NOT SPINNING	Check for mechanical failure and check motor connections. Material may be too thick, thin material.
06	MOTOR OVERHEATED	Turn sprayer OFF. Check motor connections. Check shroud vents for blockage. Sprayer may take up to an hour to cool.

Problem	What to Check	How to check
Sprayer does not run at all AND Control board status light never lights	See flow chart, page 69.	
Sprayer does not shut off AND Control board status light blinks 2 times repeatedly	Control board.	Replace control board.

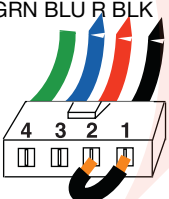
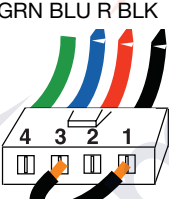
Problem	What to Check	How to check
<p>Sprayer does not run at all</p> <p>AND</p> <p>Control board status light blinks 2 times repeatedly</p>	<p>Check transducer or transducer connections</p>	<p>Make sure there is no pressure in the system (see Pressure Relief Procedure, page 16). Check fluid path for clogs, such as clogged filter.</p> <p>Use airless paint spray hose with no metal braid. A small hose or metal braid hose may result in high-pressure spikes.</p> <p>Turn ON/OFF switch OFF and disconnect power to sprayer by unplugging power cord and disconnecting battery.</p> <p>Check transducer and connections to control board.</p> <p>Disconnect transducer from control board socket. Check that transducer and control board contacts are clean and secure.</p> <p>Reconnect transducer to control board socket. Connect power, turn ON/OFF switch ON and control knob 1/2 turn clockwise. If sprayer does not run properly, turn ON/OFF switch OFF and go to next step.</p> <p>Install new transducer. Connect power, turn ON/OFF switch ON and control knob 1/2 turn clockwise. Replace control board if sprayer does not run properly.</p>
<p>Sprayer does not run at all</p> <p>AND</p> <p>Control board status light blinks 3 times repeatedly</p>	<p>Check transducer or transducer connections (control board is not detecting a pressure signal).</p>	<p>Turn ON/OFF switch OFF and disconnect power to sprayer by unplugging power cord and disconnecting battery.</p> <p>Check transducer and connections to control board.</p> <p>Disconnect transducer from control board socket. Check to see if transducer and control board contacts are clean and secure.</p> <p>Reconnect transducer to control board socket. Connect power, turn ON/OFF switch ON and control knob to 1/2 turn clockwise. If sprayer does not run, turn ON/OFF switch OFF and go to next step.</p> <p>Connect a confirmed working transducer to control board socket.</p> <p>Turn ON/OFF switch ON and control knob to 1/2 turn clockwise. If sprayer runs, install new transducer. Replace control board if sprayer does not run.</p> <p>Check transducer resistance with an ohmmeter (less than 9k ohm between red and black wires and 3-6k ohm between green and yellow wires).</p>

Problem	What to Check	How to check
<p>Sprayer does not run at all</p> <p>AND</p> <p>Control board status light blinks 5 times repeatedly</p>	<p>Control is commanding motor to run but motor shaft does not rotate. Possibly locked rotor condition, an open connection exists between motor and control, there is a problem with motor or control board, or motor amp draw is excessive.</p>	<p>Remove pump and try to run sprayer. If motor runs, check for locked or frozen pump or drive train. If sprayer does not run, continue to step 2.</p> <p>Turn ON/OFF switch OFF and disconnect power to sprayer by unplugging power cord and disconnecting battery.</p> <p>Disconnect motor connector(s) from control board socket(s). Check that motor connector and control board contacts are clean and secure. If contacts are clean and secure, continue to step 4.</p> <p>Set sprayer to OFF and spin motor fan 1/2 turn. Restart sprayer. If sprayer runs replace control board. If sprayer does not run, continue to step 5.</p> <p>Perform Spin Test: Test at large 4-pin motor field connector. Disconnect fluid pump from sprayer. Test motor by placing a jumper across pins 1 & 2. Rotate motor fan at about 2 revolutions per second. A cogging resistance to motion should be felt at the fan. The motor should be replaced if no resistance is felt. Repeat for pin combinations 1 & 3 and 2 & 3. Pin 4 (the green wire) is not used in this test. If all spin test is positive, continue to step 6.</p> <div style="text-align: center;"> <p>STEP 1:</p>  <p>STEP 2:</p>  <p>STEP 3:</p>  </div>

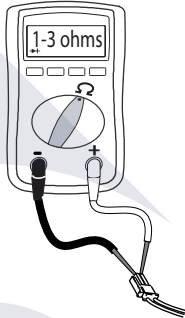
Problem	What to Check	How to check
		<p>Perform Field Short Test: Test at large 4-pin motor field connector. There should not be continuity from pin 4, the ground wire, and any of the remaining 3 pins. If motor field connector tests fail, replace motor.</p> <p>Check Motor Thermal Switch: Unplug thermal wires. Set meter to ohms. Meter should read 100k ohms.</p>  <p>Reconnect motor connector(s) to control board socket(s). Connect power, turn ON/OFF switch ON and control knob to 1/2 turn clockwise. If motor does not run, replace control board.</p>
<p>Sprayer does not run at all AND Control board status light blinks 6 times repeatedly</p>	<p>Motor is hot or there is a fault in the motor thermal device.</p>	<p>Allow sprayer to cool. If sprayer runs when cool, correct cause of overheating. Keep sprayer in cooler location with good ventilation. Make sure motor air intake is not blocked. If sprayer still does not run, replace motor.</p> <p>NOTE: Motor must be cooled down for the test.</p> <p>Check thermal device connector (yellow wires) at control board.</p> <p>Disconnect thermal device connector from control board socket. Make sure contacts are clean and secure. Measure resistance of the thermal device. If reading is not correct, replace motor.</p> <p>Check Motor Thermal Switch: Unplug thermal wires. Set meter to ohms. Meter should read 100k ohms.</p> <p>Reconnect thermal device connector to control board socket. Connect power, turn sprayer ON and control knob 1/2 turn clockwise. If sprayer does not run, replace control board.</p>
<p>Basic electrical problems</p>	<p>Motor leads are securely fastened and properly mated</p>	<p>Replace loose terminals; crimp to leads. Be sure terminal are firmly connected.</p> <p>Clean circuit board terminals. Securely reconnect leads.</p>
	<p>Motor armature commutator for burn spots, gouges or extreme roughness.</p>	<p>Remove motor and have motor shop resurface commutator if possible.</p>
<p>Inverter will not turn on during initial power up.</p>	<p>Batteries are not connected, loose battery-side connections</p>	<p>Check the batteries and cable connections. Check DC fuse and breaker. Go to battery app.</p>
	<p>Low battery voltage below 10V</p>	<p>Charge the battery with external charger (not charger on board the unit).</p>
<p>No AC output voltage and indicator lights ON.</p>	<p>Output circuit breaker tripped</p>	<p>Check circuit breaker and reset if necessary, page 71.</p>

Problem	What to Check	How to check
AC output voltage is low and the inverter turns loads OFF in a short time.	Low battery	Check the condition of the batteries and recharge if possible.
Charger is inoperative and unit will not accept AC.	AC voltage has dropped out-of-tolerance	Check the AC voltage for proper voltage and frequency.
Charger is supplying a lower charger rate.	Charger controls are improperly set.	Refer to the section on adjusting the "Charger Rate"
	Low AC input voltage.	Source qualified AC power.
	Loose battery or AC input connections.	Check all DC / AC connections.

ES 2000 Troubleshooting

Problem	What to Check	How to check
Gallon (liter) counter not adding fluid volume.	Fluid pressure not high enough.	Must be over 800 psi (55 bar) for counter to add.
	Broken or disconnected pump counter wire, both pumps.	Check wires and connections. Replace any broken wires.
	Missing or damaged magnet.	Reposition or replace magnet on pump, see Parts manual (Pump parts) for magnet location.
	Bad sensor, both pumps.	Replace sensor.
Sprayer operates, but display does not.	Bad connection between control board and display.	Remove display and reconnect.
	Display damaged.	Replace display.
Distance not adding properly (Measure mode will be inaccurate and speed will be wrong).	Machine not calibrated.	Perform calibration procedure. See Operation manual.
	Rear tire pressure is too low or too high.	Adjust tire pressure to 55 +/- 5 psi (380 +/- 34kPa).
	Gear teeth missing or damaged (right side when standing on platform).	Replace distance gear/wheel hub.
	Distance sensor is loose or broken.	Reconnect or replace sensor.
Mils not calculating or calculates wrong.	Distance sensor.	See "Distance counter not operating properly".
	Gallon counter.	See "Gallon (liter) counter not adding fluid volume."
	Line width not entered.	Set line width on main striping screen.
	Bad or damaged control board.	Replace control board.
Fluid spray starts after spray icon is shown on display.	Interrupter.	Turn screw counterclockwise until spray icon synchronizes with fluid spray, page 24.
Spray icon does not show on display when fluid is sprayed.	Loose connector.	Check connector and reconnect.
	Interrupter is improperly positioned.	Turn screw counterclockwise until spray icon synchronizes with fluid spray, page 24.
	Reed switch assembly is damaged.	Replace reed switch assembly.
	Magnet on assembly is missing.	Replace reed switch assembly.
	Cut or sliced wire.	Replace distance sensor harness.
	Control board is damaged.	Replace control board.
	Display is damaged.	Replace display.

Problem	What to Check	How to check
Spray icon is always shown on display.	Interrupter is improperly positioned.	Turn screw clockwise until spray icon is synchronized with fluid spray, page 24.
	Reed switch assembly is damaged.	Replace reed switch assembly.
AUTO GUN MODE		
Auto Gun won't actuate when the red button is pressed.	Gun is not activated.	Press the 1 or 2 button on control to activate a gun.
	Cable is not adjusted properly.	Adjust Cable to properly actuate gun trigger, page 25.
	Not on main striping screen.	Go to main striping screen on control to Actuate Auto Guns.
	Low Speed Shut off is enabled.	Disable Low Speed Shutoff, see page 49.
	Battery Voltage is too low.	Check battery voltage on Diagnostic Screen, pages 37 & 50, or with Volt meter. If below 11.5V, charge battery or replace battery.
	Cable is not adjusted properly.	Adjust Cable to properly actuate gun trigger, page 25.
	Red button is broken.	Test button functionality in Diagnostic screen, page 50, replace if broken.
	Auto Gun Cable is broken or extremely kinked resulting in too much drag.	Replace Auto Gun Cable.
	Solenoid wire is disconnected or broke.	Check Wiring Diagram, pages 111 or 114, repair or replace wires if necessary.
	Fuse to battery is removed or blown.	Check and replace fuse.
	Solenoid is jammed.	Spray Lubrication on solenoid plunger.
	Solenoid is failed.	Check resistance across solenoid wires. Resistance should be between .2 and .26 ohms. If it's not, replace solenoid.
Control board has failed.	Replace Control board.	
Line Spacing is not accurate	Wrong line pattern loaded.	Reload the correct pattern.
	Machine is out of calibration.	Calibrate the machine, page 31 or 40.
Battery won't stay charged.	Accessories are left on and drain the battery when unit is not in use.	Turn off accessories when machine is not in use.
Auto Gun won't shut off	Cable is kinked.	Repair or replace cable.
	Solenoid is jammed.	Lubricate solenoid plunger, Check for solenoid damage.
	Needle in gun is clogged.	Clean out gun.
LAYOUT MODE		
No dots or poor dots in Layout and Marking Mode.	Too small of Dot setting.	Increase Dot size, page 44.
	Gun is not activated.	Press the 1 or 2 button on control to activate a gun.
	Cable is not adjusted properly.	Adjust Cable to properly actuate gun trigger, page 25.
	Tip clog.	Clear tip or Replace tip.
	Battery voltage is too low.	Charge battery or replace battery.
	Pump is not on, or pressure is not set.	Increase pressure to a minimum of 200 psi.

Electrical (ES 2000)

Symptom: Sprayer does not run, stops running, or will not shut off.



1. Perform **Pressure Relief Procedure**, page 16.
2. Set power switch OFF for 30 seconds and then ON again (this ensures sprayer is in normal run mode).
3. Turn pressure control knob clockwise 1/2 turn.



Keep clear of electrical and moving parts during troubleshooting procedures. To avoid electrical shock hazards when covers are removed for troubleshooting, wait five minutes after unplugging power cord for stored electricity to dissipate.

4. Remove control box cover to view control board status light. To determine which code refer to the control board status light. Turn the ON/OFF switch OFF, remove the control cover then turn power back ON. Observe the status light. Blinking LED total count equals the error code (for example: two blinks equals CODE 02).

Control Board Status Light

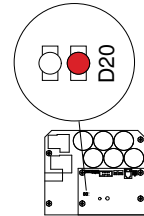
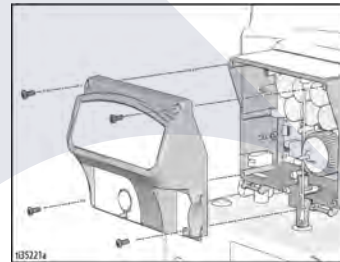

TYPE OF PROBLEM	WHAT TO CHECK	HOW TO CHECK
Sprayer does not run at all	See flow chart, page 69.	
Control board status light never lights		
Sprayer does not run at all	Check transducer or transducer connections	<ol style="list-style-type: none"> 1. Make sure there is no pressure in the system (see Pressure Relief Procedure, page 16). Check fluid path for clogs, such as clogged filter. 2. Use airless paint spray hose with no metal braid 3/8 x 20' minimum. Smaller hose or metal braid hose may result in high-pressure spikes. 3. Set sprayer to OFF and disconnect power to sprayer. 4. Check transducer and connections to control board. 5. Disconnect transducer from control board socket. Check that transducer and control board contacts are clean and secure. 6. Reconnect transducer to control board socket. Connect power, set sprayer ON and control knob 1/2 turn clockwise. If sprayer does not run properly, set sprayer to OFF and go to next step. 7. Install new transducer. Connect power, set sprayer ON and control knob 1/2 turn clockwise. Replace control board if sprayer does not run properly.
Control board status light blinks 2 times repeatedly		

TYPE OF PROBLEM	WHAT TO CHECK	HOW TO CHECK
Sprayer does not run at all Control board status light blinks 3 times repeatedly	Check transducer or transducer connections (control board is not detecting a pressure signal).	<ol style="list-style-type: none"> 1. Set sprayer to OFF and disconnect power to sprayer. 2. Check transducer and connections to control board. 3. Disconnect transducer from control board socket. Check to see if transducer and control board contacts are clean and secure. 4. Reconnect transducer to control board socket. Connect power, set sprayer ON and control knob to 1/2 turn clockwise. If sprayer does not run, set sprayer to OFF and go to next step. 5. Connect a confirmed working transducer to control board socket. 6. Set sprayer ON and control knob to 1/2 turn clockwise. If sprayer runs, install new transducer. Replace control board if sprayer does not run. 7. Check transducer resistance with ohmmeter (less than 9k ohm between red and black wires and 3-6k ohm between green and yellow wires).
Sprayer does not run at all Control board status light blinks 4 times repeatedly	Check voltage supply to the sprayer (control board is detecting multiple voltage surges).	<ol style="list-style-type: none"> 1. Set sprayer to OFF and disconnect power to sprayer. 2. Locate a good voltage supply to prevent damage to electronics. 3. See Sprayer Will Not Shut Off (ES 1000 & ES 2000), page 71.

TYPE OF PROBLEM	WHAT TO CHECK	HOW TO CHECK
<p>Sprayer does not run at all</p> <p>Control board status light blinks 5 times repeatedly</p>	<p>Control is commanding motor to run but motor shaft does not rotate. Possibly locked rotor condition, an open connection exists between motor and control, there is a problem with motor or control board, or motor amp draw is excessive.</p>	<ol style="list-style-type: none"> 1. Remove pump and try to run sprayer. If motor runs, check for locked or frozen pump or drive train. If sprayer does not run, continue to step 2. 2. Set sprayer to OFF and disconnect power to sprayer. 3. Disconnect motor connector(s) from control board socket(s). Check that motor connector and control board contacts are clean and secure. If contacts are clean and secure, continue to step 4. 4. Set sprayer to OFF and spin motor fan 1/2 turn. Restart sprayer. If sprayer runs, replace control board. If sprayer does not run, continue to step 5. 5. Perform Spin Test: Test at large 4-pin motor field connector. Disconnect fluid pump from sprayer. Test motor by placing a jumper across pins 1 & 2. Rotate motor fan at about 2 revolutions per second. A cogging resistance to motion should be felt at the fan. The motor should be replaced if no resistance is felt. Repeat for pin combinations 1 & 3 and 2 & 3. Pin 4 (the green wire) is not used in this test. If all spin test is positive, continue to step 6. <div style="text-align: center;"> <p>STEP 1:</p> <p>STEP 2:</p> <p>STEP 3:</p> </div>

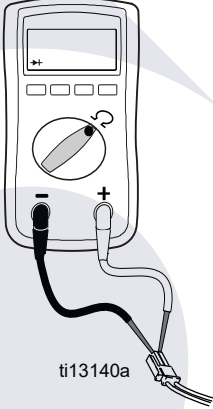
TYPE OF PROBLEM	WHAT TO CHECK	HOW TO CHECK				
Sprayer does not run at all Control board status light blinks 5 times repeatedly	Control is commanding motor to run but motor shaft does not rotate. Possibly locked rotor condition, an open connection exists between motor and control, there is a problem with motor or control board, or motor amp draw is excessive.	6. Perform Field Short Test: Test at large 4-pin motor field connector. There should not be continuity from pin 4, the ground wire, and any of the remaining 3 pins. If motor field connector tests fail, replace motor. 7. Check Motor Thermal Switch: Unplug thermal wires. Set meter to ohms. Meter should read the proper resistance for each unit (see table below).  <table border="1" data-bbox="881 1031 1349 1100"> <thead> <tr> <th colspan="2">Resistance Table:</th> </tr> </thead> <tbody> <tr> <td>ES 2000</td> <td>2k ohms</td> </tr> </tbody> </table>	Resistance Table:		ES 2000	2k ohms
Resistance Table:						
ES 2000	2k ohms					

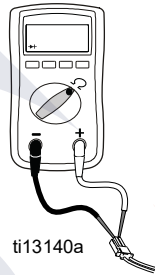
TYPE OF PROBLEM	WHAT TO CHECK	HOW TO CHECK				
Sprayer does not run at all Control board status light blinks 6 times repeatedly	Allow sprayer to cool. If sprayer runs when cool, correct cause of overheating. Keep sprayer in cooler location with good ventilation. Make sure motor air intake is not blocked. If sprayer still does not run, follow Step 1.	<p>NOTE: Motor must be cooled down for the test.</p> <ol style="list-style-type: none"> 1. Check thermal device connector (yellow wires) at control board. 2. Disconnect thermal device connector from control board socket. Make sure contacts are clean and secure. Measure resistance of the thermal device. If reading is not correct, replace motor. <p>Check Motor Thermal Switch: Unplug thermal wires. Set meter to ohms. Meter should read the proper resistance for each unit (see table below).</p>  <table border="1" data-bbox="980 863 1451 936"> <thead> <tr> <th colspan="2">Resistance Table:</th> </tr> </thead> <tbody> <tr> <td>ES 2000</td> <td>2k ohms</td> </tr> </tbody> </table> <ol style="list-style-type: none"> 3. Reconnect thermal device connector to control board socket. Connect power, turn sprayer ON and control knob 1/2 turn clockwise. If sprayer does not run, replace control board. 	Resistance Table:		ES 2000	2k ohms
Resistance Table:						
ES 2000	2k ohms					
Sprayer does not run at all Control board status light blinks 8 times repeatedly	Check voltage supply to the sprayer (incoming voltage too low for sprayer operation)	<ol style="list-style-type: none"> 1. Set sprayer to OFF and disconnect power to sprayer. 2. Troubleshoot inverter. 				
Sprayer does not run at all Control board status light blinks 10 times repeatedly	Check to see if control board is over heating.	<ol style="list-style-type: none"> 1. Make sure motor air intake is not blocked. 2. Make sure fan has not failed. 3. Make sure control board is properly connected to back plate and that conductive thermal paste is used on power components. 4. Replace control board. 5. Replace motor. 				
Sprayer does not run at all Control board status light blinks 12 times repeatedly	Excessive current protection enabled	<ol style="list-style-type: none"> 1. Cycle power on and off. 				
Sprayer does not run at all Control board status light blinks 15 times repeatedly	Check the connections above the motor	<ol style="list-style-type: none"> 1. Set sprayer to OFF and disconnect power to sprayer. 2. Remove motor shroud. 3. Disconnect motor control and inspect for damage at connectors. 4. Reconnect motor control. 5. Turn power on. If code continues, replace motor. 				

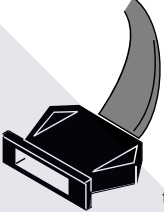
TYPE OF PROBLEM	WHAT TO CHECK	HOW TO CHECK
Sprayer does not run at all Control board status light blinks 16 times repeatedly	Check the connections. Control is not receiving a motor position sensor signal	<ol style="list-style-type: none"> 1. Turn power OFF. 2. Disconnect motor position sensor and inspect for damage at connectors. <div style="text-align: center;">  <p>ti18685a</p> </div> <ol style="list-style-type: none"> 3. Reconnect sensor. 4. Turn power ON. If code continues, replace motor.
Sprayer does not run at all Control board status light blinks 17 times repeatedly	Check voltage supply to the sprayer (sprayer plugged into wrong voltage)	<ol style="list-style-type: none"> 1. Set sprayer to OFF and disconnect power to sprayer. 2. Locate a good voltage supply to prevent damage to electronics. 3. See Sprayer Will Not Shut Off (ES 1000 & ES 2000), page 71.

goind.com.au

Sprayer Will Not Run (ES 1000 & ES 2000)

(See following page for steps)

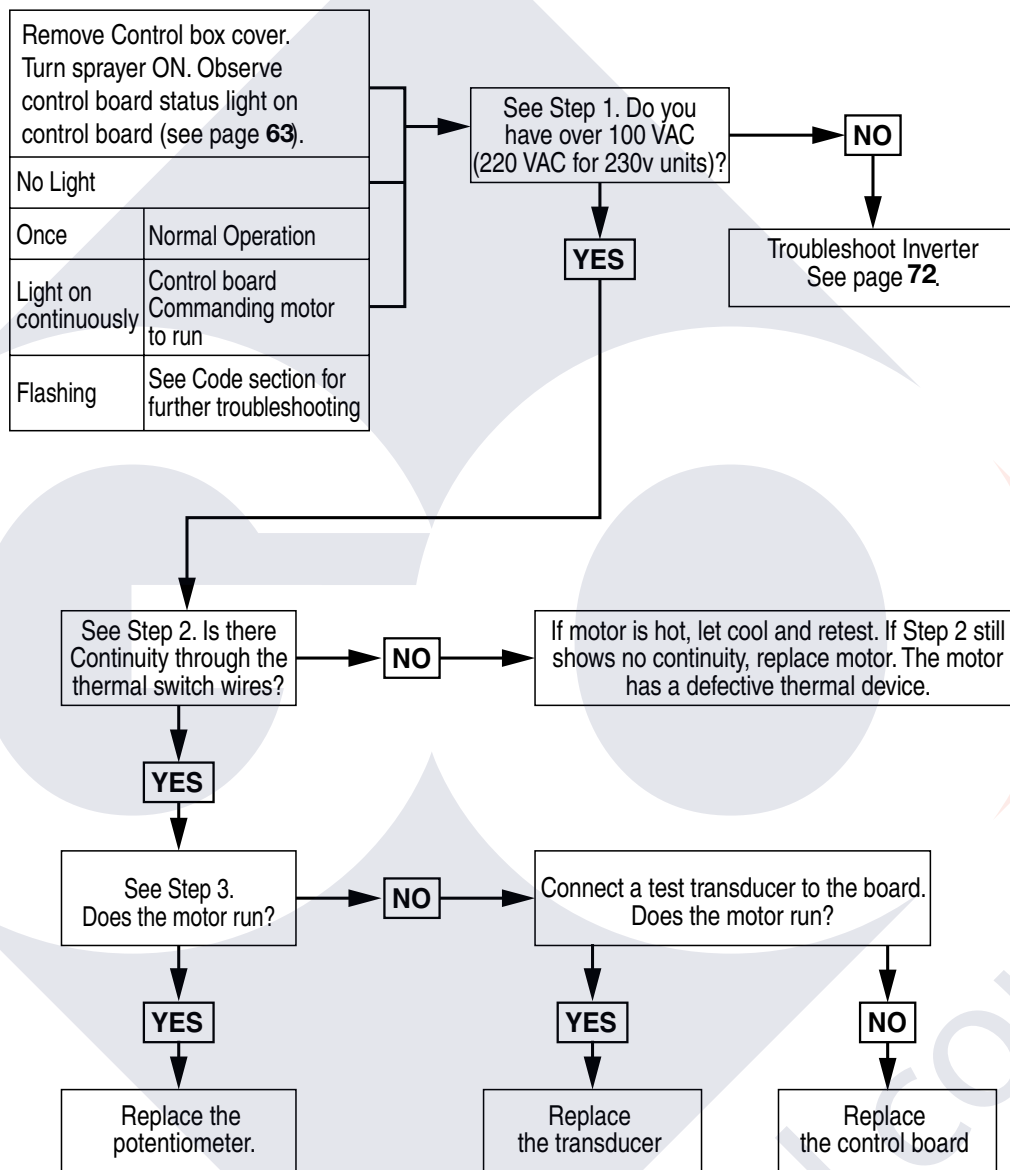

ti30335a

Step 1:

Plug Power cord in and turn switch ON. Connect probes to control board. Turn meter to AC Volts.

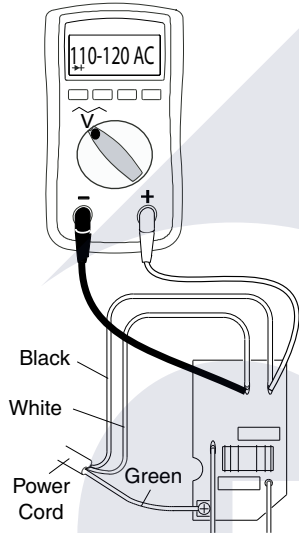

Step 2:

Check motor thermal switch. Unplug yellow wires. Meter should read 100 ohms. NOTE: Motor should be cool during reading.

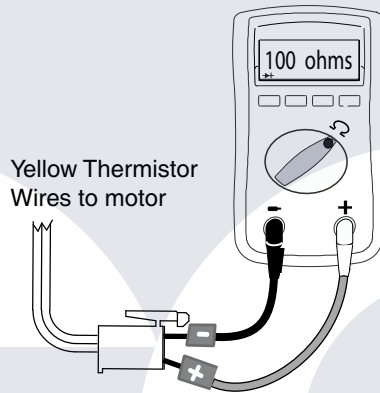

Step 3:

Disconnect potentiometer. Plug power cord in and turn switch ON.

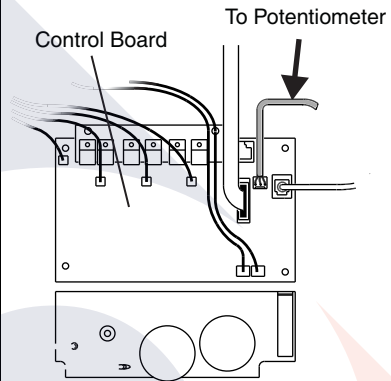

Step 4:

Connect probes to positive and negative posts on inverter.

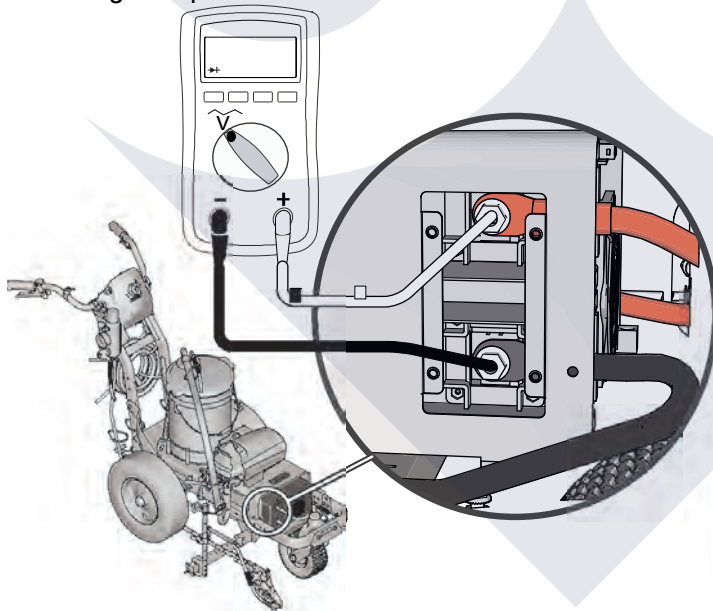

Step 5:

Connect jumper across pins 1 and 2

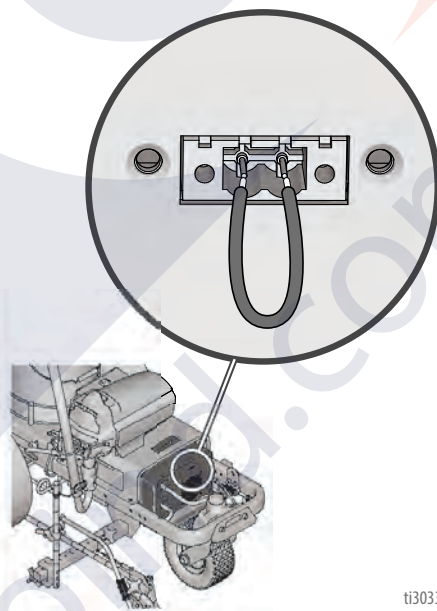

ti30331a

Sprayer Will Not Shut Off (ES 1000 & ES 2000)

1. Perform **Pressure Relief Procedure**, page 16. Leave prime valve open (down) and turn ON/OFF switch **OFF**.
2. Remove control box cover so the control board status light can be viewed if available.

Troubleshooting Procedure

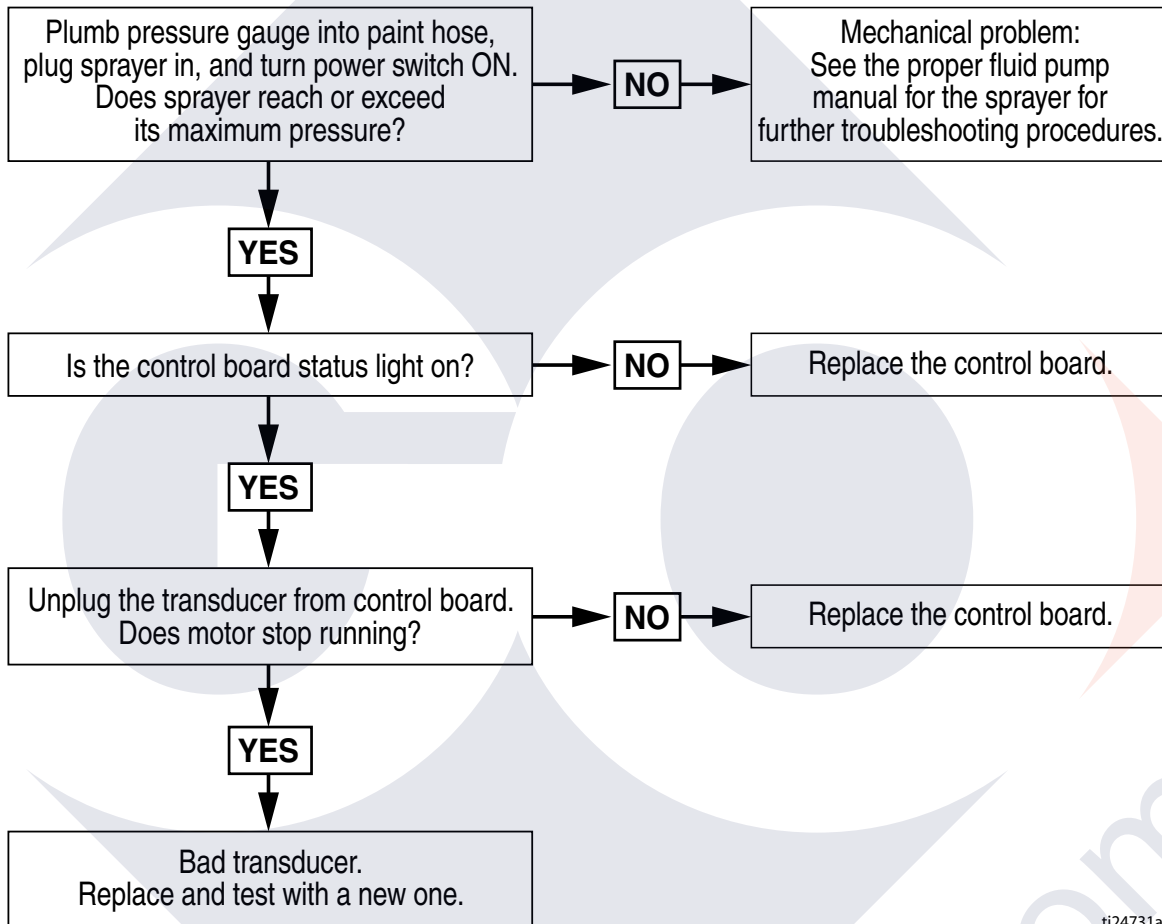

Inverter (ES 1000 & ES 2000)

The inverter has 2 circuit breakers, and an LED Status Center that communicates inverter operation status.

See chart below for different functions, alarms, and fault modes.

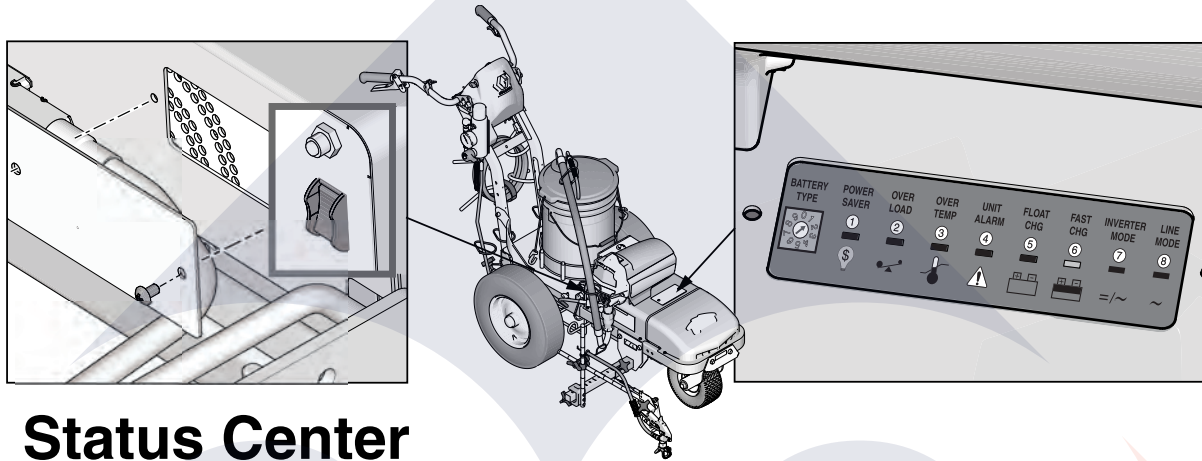

Status Center

BATTERY TYPE	POWER SAVER	OVER LOAD	OVER TEMP	UNIT ALARM	FLOAT CHG	FAST CHG	INVERTER MODE	LINE MODE
	①	②	③	④	⑤	⑥	⑦	⑧

Indication & Fault finding chart

Status	L.E.D.s Function	Alarm								
		①	②	③	④	⑤	⑥	⑦	⑧	
Charge function	Constant current charge						on Flash		on	
	Constant voltage charge								on	
	Float					on			on	
	Standby								on	
Inverter mode	Inverter on							on		
Alarms	Battery low voltage				on			on	beep 0.5s every 5 s	
	Battery high voltage				on			on	beep 0.5s every 5 s	
	Over load (inverter mode)		on		on			on	beep 0.5s every 5 s	
	Over temp (inverter mode)			on	on			on	beep 0.5s every 5 s	
	Over temp (line mode)			on	on	on			on	beep 0.5s every 5 s
	Over charge				on	on			on	beep 0.5s every 5 s
Fault mode	Fan lock								beep continuous	
	Battery high voltage							on	beep continuous	
	Inverter mode overload		on						beep continuous	
	Over temperature			on					beep continuous	

1130334a

Sprayer does not have - 100 VAC for 120V units - 220 VAC for 230V units (ES 1000& ES 2000)

Troubleshooting Procedure:

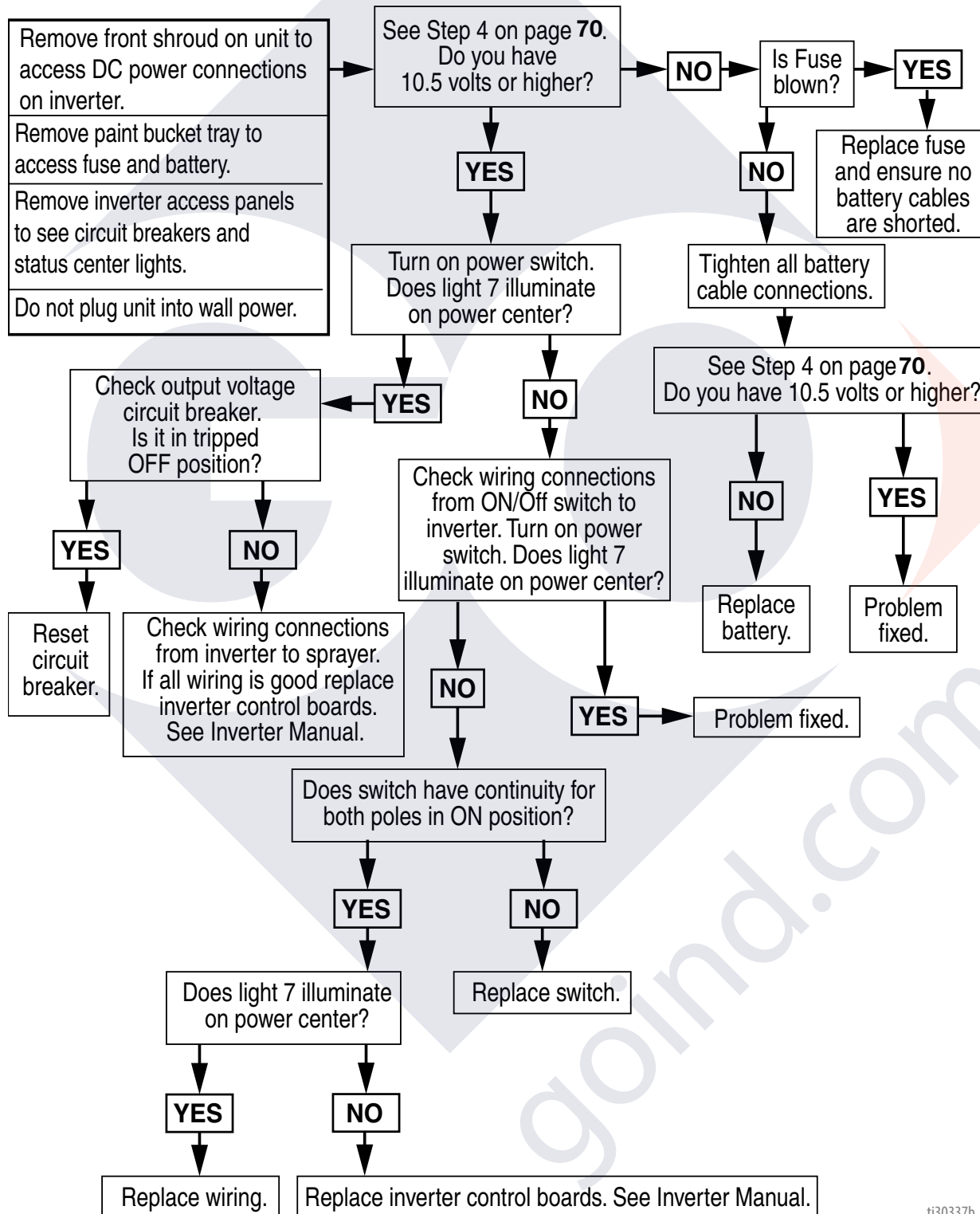

ti30337b

Battery Will Not Charge (ES 1000 & ES 2000)

Troubleshooting Procedure:

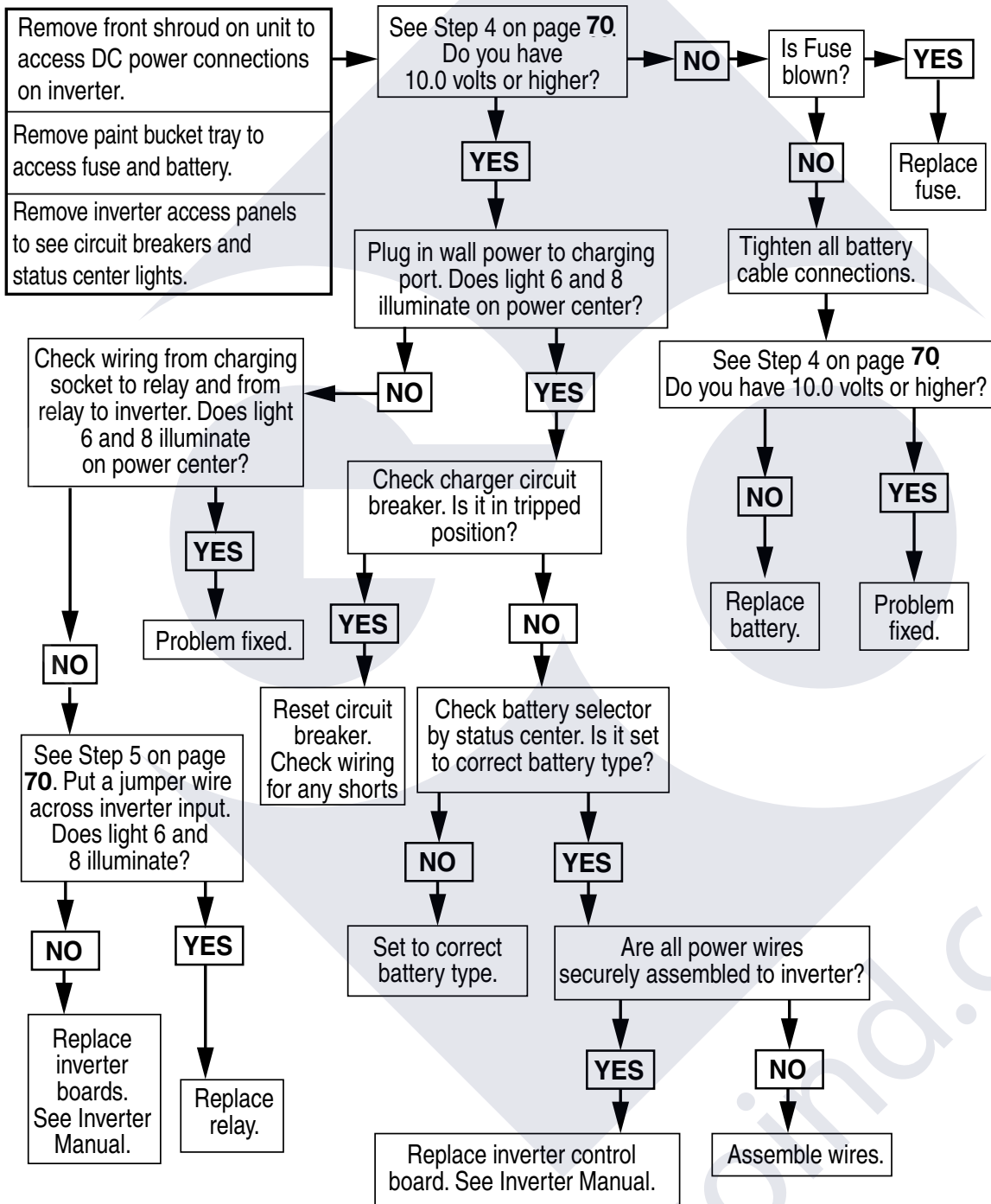

ti30338b