

Fast and Simple Label Creation Right at your Fingertips



USER MANUAL

BradyPrinter S3100 Sign & Label Printer

BradyID.com.au/S3100

Copyright and Trademarks

Disclaimer

This manual is proprietary to **Brady** Worldwide, Inc. (hereafter "**Brady**"), and may be revised from time to time without notice. **Brady** disclaims any understanding to provide you with such revisions, if any.

This manual is copyrighted with all rights reserved. No portion of this manual may be copied or reproduced by any means without the prior written consent of **Brady**.

While every precaution has been taken in the preparation of this document, **Brady** assumes no liability to any party for any loss or damage caused by errors or omissions or by statements resulting from negligence, accident, or any other cause. **Brady** further assumes no liability arising out of the application or use of any product or system described, herein; nor any liability for incidental or consequential damages arising from the use of this document. **Brady** disclaims all warranties of merchantability of fitness for a particular purpose.

Brady reserves the right to make changes without further notice to any product or system described herein to improve reliability, function, or design.

Trademarks

Microsoft, Windows, Excel, Access and SQL Server are registered trademarks of Microsoft Corporation.

All brand or product names referenced in this manual are trademarks (™) or registered trademarks (®) of their respective companies or organizations.

© 2018 **Brady Corporation**. All Rights Reserved.

Y4546717

Revision B

Brady Corporation

6555 West Good Hope Road

P.O. Box 2131

Milwaukee, WI 53201-2131

www.bradycorp.com

Sales/Customer Support:(888) 250-3082

End User License Agreement for Microsoft Windows CE®

You have acquired a device that includes software licensed by Brady Worldwide, Inc. from Microsoft Licensing or its affiliates (“MS”). Those installed software products of Microsoft origin, as well as associated media, printed materials, and “online” or electronic documentation (“SOFTWARE”) are protected by international intellectual property laws and treaties. The SOFTWARE is licensed, not sold. All rights reserved.

IF YOU DO NOT AGREE TO THIS END USER LICENSE AGREEMENT, DO NOT USE THE DEVICE OR COPY THE SOFTWARE. INSTEAD, PROMPTLY CONTACT BRADY WORLDWIDE, INC. FOR INSTRUCTIONS ON RETURN OF THE UNUSED DEVICE FOR A REFUND. **ANY USE OF THE SOFTWARE, INCLUDING BUT NOT LIMITED TO USE ON THE DEVICE, WILL CONSTITUTE YOUR AGREEMENT TO THIS END USER LICENSE AGREEMENT (OR RATIFICATION OF ANY PREVIOUS CONSENT).**

GRANT OF SOFTWARE LICENSE: This End User License Agreement grants you the following license:

You may use the SOFTWARE only on the DEVICE.

NOT FAULT TOLERANT. THE SOFTWARE IS NOT FAULT TOLERANT. BRADY WORLDWIDE, INC. HAS INDEPENDENTLY DETERMINED HOW TO USE THE SOFTWARE IN THE DEVICE, AND MS HAS RELIED UPON BRADY WORLDWIDE, INC. TO CONDUCT SUFFICIENT TESTING TO DETERMINE THAT THE SOFTWARE IS SUITABLE FOR SUCH USE.

NO WARRANTIES FOR THE SOFTWARE. **The SOFTWARE is provided “as is” and with all faults. THE ENTIRE RISK AS TO SATISFACTORY QUALITY, PERFORMANCE, ACCURACY, AND EFFORT (INCLUDING LACK OF NEGLIGENCE) IS WITH YOU. ALSO, THERE IS NO WARRANTY AGAINST INTERFERENCE WITH YOUR ENJOYMENT OF THE SOFTWARE OR AGAINST INFRINGEMENT.** IF YOU HAVE RECEIVED ANY WARRANTIES REGARDING THE DEVICE OR THE SOFTWARE, THOSE WARRANTIES DO NOT ORIGINATE FROM, AND ARE NOT BINDING ON, MS.

Note on Java support. The SOFTWARE may contain support for programs written in Java. Java technology is not fault tolerant and is not designed, manufactured, or intended for use or resale as online control equipment in hazardous environments requiring fail-safe performances, such as in the operation of nuclear facilities, aircraft navigation or communication systems, air traffic control, direct life support machines, or weapons systems, in which the failure of Java technology could lead directly to death, personal injury, or severe physical or environmental damage. Sun Microsystems, Inc. has contractually obligated MS to make this disclaimer.

No Liability for Certain Damages. EXCEPT AS PROHIBITED BY LAW, MS SHALL HAVE NO LIABILITY FOR ANY INDIRECT, SPECIAL, CONSEQUENTIAL OR INCIDENTAL DAMAGES ARISING FROM OR IN CONNECTION WITH THE USE OR PERFORMANCE OF THE SOFTWARE. THIS LIMITATION SHALL APPLY EVEN IF ANY REMEDY FAILS OF ITS ESSENTIAL PURPOSE. IN NO EVENT SHALL MS BE LIABLE FOR ANY AMOUNT IN EXCESS OF U.S. TWO HUNDRED FIFTY DOLLARS (U.S.\$250.00).

Limitations on Reverse Engineering, Decompilation, and Disassembly. You may not reverse engineer, decompile, or disassemble the SOFTWARE, except and only to the extent that such activity is expressly permitted by applicable law not withstanding this limitation.

SOFTWARE TRANSFER ALLOWED BUT WITH RESTRICTIONS. You may permanently transfer rights under this End User License Agreement only as part of a permanent sale or transfer of the Device, and only if the recipient agrees to this End User License Agreement. If the SOFTWARE is an upgrade, any transfer must also include all prior versions of the SOFTWARE.

EXPORT RESTRICTIONS. You acknowledge that SOFTWARE is of US-origin. You agree to comply with all applicable international and national laws that apply to the SOFTWARE, including the U.S. Export Administration Regulations, as well as end-user, end-use, and country destination restrictions issued by U.S. and other governments. For additional information on exporting the SOFTWARE, see <http://www.microsoft.com/exporting>.

Brady Warranty

Our products are sold with the understanding that the buyer will test them in actual use and determine for him or herself their adaptability to his/her intended uses. Brady warrants to the buyer that its products are free from defects in material and workmanship, but limits its obligation under this warranty to replacement of the product shown to Brady's satisfaction to have been defective at the time Brady sold it. This warranty does not extend to any persons obtaining the product from the buyer.

THIS WARRANTY IS IN LIEU OF ANY OTHER WARRANTY, EXPRESS OR IMPLIED, INCLUDING, BUT NOT LIMITED TO, ANY IMPLIED WARRANTY OF MERCHANTABILITY OR FITNESS FOR A PARTICULAR PURPOSE, AND OF ANY OTHER OBLIGATIONS OR LIABILITY ON BRADY'S PART. UNDER NO CIRCUMSTANCES WILL BRADY BE LIABLE FOR ANY LOSS, DAMAGE, EXPENSE OR CONSEQUENTIAL DAMAGES OF ANY KIND ARISING IN CONNECTION WITH THE USE, OR INABILITY TO USE, BRADY'S PRODUCTS.

Agency Compliance and Approvals

United States

FCC Notice

Note: This equipment has been tested and found to comply with the limits for a Class A digital device, pursuant to part 15 of the FCC Rules. These limits are designed to provide reasonable protection against harmful interference when the equipment is operated in a commercial environment. This equipment generates, uses, and can radiate radio frequency energy and, if not installed and used in accordance with the instruction manual, may cause harmful interference to radio communications.

Operation of this equipment in a residential area is likely to cause harmful interference in which case the user will be required to correct the interference at his own expense.

Changes or modifications not expressly approved by the party responsible for compliance could void the user's authority to operate the equipment.

This device complies with Part 15 of the FCC Rules. Operation is subject to the following two conditions: (1) This device may not cause harmful interference and, (2) this device must accept any interference received, including interference that may cause undesired operation.

Canada

Innovation, Science and Economic Development (ISED)

Canada ICES-003:

CAN ICES-3 (A)/NMB-3(A)

Mexico

IFETEL notice: La operación de este equipo está sujeta a las siguientes dos condiciones: (1) es posible que este equipo o dispositivo no cause interferencia perjudicial y (2) este equipo o dispositivo debe aceptar cualquier interferencia, incluyendo la que pueda causar su operación no deseada.

Europe



WARNING

This is a Class A product. In a domestic environment, this product may cause radio interference in which case the user may be required to take adequate measures.



Waste Electrical and Electronic Equipment Directive

In accordance with the European WEEE Directive, this device needs to be recycled in accordance with local regulations.

RoHS Directive 2011/65/EU (RoHS 2), 2015/863/EU (RoHS 3)

This product is CE marked and complies with the European Union's Directive 2011/65/EU OF THE EUROPEAN PARLIAMENT AND OF THE COUNCIL of 8 June 2011 on the restriction of the use of certain hazardous substances in electrical and electronic equipment.

EU Directive 2015/863 of 31 March 2015 (RoHS 3) amends Annex II to Directive 2011/65/EU of the European Parliament and of the Council as regards the list of restricted substances.

Batteries Directive 2006/66/EC



This product contains a lithium coin cell battery. The crossed-out wheeled bin shown to the left is used to indicate 'separate collection' for all batteries and accumulators in accordance with European Directive 2006/66/EC. Users of batteries must not dispose of batteries as unsorted municipal waste. This Directive determines the framework for the return and recycling of used batteries and accumulators that are to be collected separately and recycled at end of life. Please dispose of the battery according to your local regulations.

Notice to Recyclers

To remove the lithium coin cell battery:

1. Disassemble printer and locate the lithium coin cell battery located on the main circuit board.
2. Using a small screwdriver, pry the battery from its holder and remove the battery from the board. Dispose of in accordance with local regulations.

Turkey

Turkish Ministry of Environment and Forestry

(Directive on the Restriction of the use of certain hazardous substances in electrical and electronic equipment).

Türkiye Cumhuriyeti: EEE Yönetmeliğine Uygundur

China

S3100 Printer 打印机 Hazardous Substances 有害物质

Part Name 零件名称	Lead (Pb) 铅(Pb)	Mercury (Hg) 汞(Hg)	Cadmium (Cd) 镉(Cd)	Hexavalent Chromium Cr (VI) 六价铬 Cr (VI)	Polybrominated biphenyls (PBB) 聚溴联苯 (PBB)	Polybrominated diphenyl ethers (PBDE) 聚溴二苯醚 (PBDE)
Internal Power Supply 内部电源	X	O	O	O	O	O
Display 显示	X	O	O	O	O	O
Electronics 电子产品	O	O	O	O	O	O
Enclosure 附件	O	O	O	O	O	O
Keyboard 键盘	X	O	O	O	O	O
Metal Parts 金属零件	O	O	O	O	O	O
Printed Wiring Assemblies (PWA) 印刷线路板组件 (PWA)	X	O	O	O	O	O
Motor 发动机	X	O	O	O	O	O

This table is prepared in accordance with the provisions of SJ/T 11364:2014.

此表是按照 SJ/ T11364 的规定编制。

O: Indicates that said hazardous substance contained in all of the homogeneous materials for this part is below the limit requirement of GB/T 26572.

O 表示该说包含在所有均质材料中的有害物质这部分低于 GB/ T26572 的限量要求。

X: Indicates that said hazardous substance contained in at least one of the homogeneous materials used for this part is above the limit requirement of GB/T 26572.

X: 表示所述包含在用于该部分的均质材料中的至少一种有害物质是上述 GB / T26572 的限制要求。

Taiwan

Class A Statement

警告使用者

這是甲類的資訊產品，在居住的環境中使用時，可能會造成射頻干擾，在這種情況下，使用者會被要求採取某些適當的對策。

限用物質含有情況標示聲明書

Declaration of the Presence Condition of the Restricted Substances Marking

S3100 標誌和標籤印表機 限用物質含有情況標示

設備名稱: 標誌和標籤打印機 / Sign and Label Printer		型號 (型式): BradyPrinter 3100				
Equipment name:		Type designation (Type)				
限用物質及其化學符號 Restricted substances and its chemical symbols						
	鉛 Lead (Pb)	汞 Mercury (Hg)	鎘 Cadmium (Cd)	六價鉻 Hexavalent chromium (Cr+6)	多溴聯苯 Polybrominated biphenyls (PBB)	多溴二苯醚 Polybrominated diphenyl ethers (PBDE)
Power Supply 電源供應器	—	0	0	0	0	0
Display Panel 顯示面板	—	0	0	0	0	0
Keyboard 鍵盤	—	0	0	0	0	0
Metal Parts 金屬零件	0	0	0	0	0	0
Printed Circuit Board 印刷線路板 組件	—	0	0	0	0	0
Motor 馬達	—	0	0	0	0	0
Cutter 切刀	0	0	0	0	0	0
Print Head 列印頭	—	0	0	0	0	0
備考 1. “超出 0.1 wt %” 及 “超出 0.01 wt %” 係指限用物質之百分比含量超出百分比含量基準值。 Note 1 : “Exceeding 0.1 wt %” and “exceeding 0.01 wt %” indicate that the percentage content of the restricted substance exceeds the reference percentage value of presence condition.						
備考 2. “○” 係指該項限用物質之百分比含量未超出百分比含量基準值。 Note 2 : “○” indicates that the percentage content of the restricted substance does not exceed the percentage of reference value of presence.						
備考 3. “—” 係指該項限用物質為排除項目。 Note 3 : The “—” indicates that the restricted substance corresponds to the exemption.						

Wireless Regulatory Information

Regulatory markings, subject to country certification, are applied to host printer signifying WiFi (radio) approvals have been obtained. These countries include; U.S., Canada, Mexico, European Union, Brazil, Australia, New Zealand, South Africa, and South Korea.



WARNING

Operation of the device without regulatory approval is illegal.

WiFi radio module (permanently installed in printer having WiFi option)

Radio protocol	WLAN IEEE 802.11b/g/n
RF Operating Frequency	2.4 – 2.495 GHz
RF Output Power	< +20dBm EIRP (100mW)
Antenna Type \ Antenna Gain	PCB trace antenna \ -3.06 dBi
Environmental Operation	-40 to 85° C (-40° to 185° F) Note: Be mindful of Brady host printer user guide for maximum operating temperatures
Environmental Storage	-55 to 125° C (-67° to 257° F) Note: Be mindful of Brady host printer user guide for maximum storage temperatures

United States

Note: This equipment has been tested and found to comply with the limits for a Class A digital device, pursuant to part 15 of the FCC Rules. These limits are designed to provide reasonable protection against harmful interference when the equipment is operated in a commercial environment. This equipment generates, uses, and can radiate radio frequency energy and, if not installed and used in accordance with the instruction manual, may cause harmful interference to radio communications.

Operation of this equipment in a residential area is likely to cause harmful interference in which case the user will be required to correct the interference at own expense.

Changes or modifications not expressly approved by the party responsible for compliance could void the user's authority to operate the equipment.

This device complies with Part 15 of the FCC Rules. Operation is subject to the following two conditions: (1) This device may not cause harmful interference and, (2) this device must accept any interference received, including interference that may cause undesired operation.

Co-located statements: To comply with FCC RF exposure compliance requirement, the antenna used for this transmitter must not be co-located or operating in conjunction with any other transmitter/antenna except those already with radio module filing.

RF exposure guidelines: The radiated output power of this device is far below the radio frequency exposure limits. Nevertheless, to avoid the possibility of exceeding radio frequency exposure limits for an uncontrolled environment, a minimum 20cm distance should be maintained from WiFi radio module PCB antenna (internal) to the head, neck, or body during normal operation.

Canada

Innovation, Science and Economic Development (ISED)

CAN ICES-3 (A)/NMB-3(A)

This device complies with Industry Canada's license-exempt RSSs. Operation is subject to the following two conditions:

1. This device may not cause interference; and
2. This device must accept any interference, including interference that may cause undesired operation of the device.

Co-located statements: To comply with FCC RF exposure compliance requirement, the antenna used for this transmitter must not be co-located or operating in conjunction with any other transmitter/antenna except those already with radio module filing.

RF exposure guidelines / Important note: This equipment complies with IC radiation exposure limits set forth for an uncontrolled environment. This equipment should be installed and operated with minimum distance 20cm between the radiator and your body.

Note Importante: Déclaration d'exposition aux radiations: Cet équipement est conforme aux limites d'exposition aux rayonnements IC établies pour un environnement non contrôlé. Cet équipement doit être installé et utilisé avec un minimum de 20cm de distance entre la source de rayonnement et votre corps.

Mexico

IFETEL notice:

"La operación de este equipo está sujeta a las siguientes dos condiciones: (1) es posible que este equipo o dispositivo no cause interferencia perjudicial y (2) este equipo o dispositivo debe aceptar cualquier interferencia, incluyendo la que pueda causar su operación no deseada."

European Union

This is a Class A product. In a domestic environment, this product may cause radio interference in which case the user may be required to take adequate measures.

Radio Equipment Directive (RED) 2014/53/EC

- a. Frequency band(s) in which the radio equipment operates; 2.401GHz to 2.483GHz
- b. Maximum radio-frequency power transmitted in the frequency band(s) in which the radio equipment operate; < +20dBm EIRP (100mW)

International

The WiFi radio module used in Brady host printers comply with internationally recognized standards covering human exposure to electromagnetic fields, i.e. EN 62311 "Assessment of electronic and electrical equipment related to human exposure restrictions for electromagnetic fields (0 Hz - 300 GHz)".

Safety and Environment

Please read and understand this manual before using the BradyPrinter S3100 Sign & Label Printer for the first time. This manual describes all of the main functions of the BradyPrinter S3100 printer.

Precautions

Before using the BradyPrinter S3100 printer, please note the following precautions:

- Read all instructions carefully before operating the printer and prior to performing any procedure.
- Do not place the unit on an unstable surface or stand.
- Do not place anything on top of the unit.
- Keep the top clear of obstructions.
- Always use the printer in a well ventilated area. Do not block the slots and opening on the unit, which are provided for ventilation.
- Only use the power source indicated on the rating label.
- Use only the power cord that comes with the unit.
- Do not place anything on the power cord.

Technical Support and Registration

Contact Information

For repair or technical assistance, locate your regional Brady Technical Support office by going to:

- **United States:** www.bradyid.com
- **Europe:** www.bradyeurope.com
- **Asia Pacific:** www.brady.co.uk/landing-pages/global-landing-page
- **Australia:** www.bradyid.com.au
- **Canada:** www.bradycanada.ca
- **Latin America:** www.bradylatinamerica.com

Registration Information

To register your printer, go to:

- www.bradycorp.com/register
- **Australia:** www.bradyid.com.au/register
- **China:** www.brady.com.cn/membercenter/register_product.aspx

Repair and Return

If for any reason you need to return the BradyPrinter S3100 printer for repair, please contact Brady Technical Support for repair and replacement information.

Document Conventions

When using this document, it is important that you understand the conventions used throughout the manual.

- All user actions are indicated by **Bold** text.
- References to menus, dialog boxes, button and screens are indicated by *Italics* text.
- See “*About Menus, Dialog Boxes and Screens*” on page 3 for a description of the menus and controls.

Contents

1 • Introduction

Features and Functions	1
Compatible Applications	2
System Specifications	2
About Menus, Dialog Boxes and Screens	3
Home Page	3
Tools Panel	4
Button Actions	5

2 • Setting up Your Printer

Unpacking and Setting up Printer	6
What's in the Box	6
System Components	7
Setting up the Printer	8
System Power	13
Starting Printer from a Non-powered (Cold) State	13
Waking the Printer from Sleep Mode	13
Putting the Printer into Sleep Mode	14
Resetting the Printer	14
Using Your Printer with a PC	15
Configuring the Printer for Network Communication	15
Configuring a Direct USB Connection	19
Creating and Printing Labels from a PC	19
Setting up the System Defaults	20
Set Clock	20
Localization and Unit of Measure	21
Set Text Defaults	22
Set Barcode Defaults	23
Set Printing	24
Customizing Home Page Defaults	25
Displaying System Information	26

3 • Working with Labels

Creating Labels	27
Creating a Text Label	27
Creating a Label from a Template	28
Creating a Custom Label	30
Set Label Attributes	31
Creating Fixed-Length Label	31
Creating Auto-Sized Label	31
Orientation	32
Label Width	33
Framing a Label	35

Tools	36
Zooming the Label View	36
Scrolling the Label View	36
4 • Working with Objects	
Object Types	37
Object Sizing	37
Adding Objects	38
Text Objects	38
Graphic Objects	39
Shapes	39
Barcode Objects	41
Serial Objects	42
Date/Time Objects	44
Working with Text	46
Selecting or Deselecting Text	46
Increase or Decrease Text Size	47
Delete/Clear Text	47
Changing Character Font, Size or Style	48
Horizontal Text Justification	48
Vertical Text	49
Expanding or Condensing Text	49
Reversing Text	50
Typing Text and Accented Characters	50
Entering Special Characters	53
Working with Barcodes	54
Changing a Barcode	54
Changing Barcode Options	55
Handling Objects	57
Editing Objects	57
Moving Objects	57
Aligning Objects	59
Sizing Objects	60
Deleting an Object	62
Framing an Object	62
Rotating an Object	63
Converting Text or Barcode to Variable Data	64
5 • Printing Your Labels	
Previewing Labels	67
Printing Labels	68
Printing Labels	68
Canceling a Print Job	69
Resuming an Interrupted Print Job	69
Feeding and Cutting Label Stock	69
Adjusting Print Energy	70
Adjusting Print Offset	71
Printing from a PC	72

6 • Working with Label Files	
Save a Label File	73
Open a Label File	74
Delete a Label File.....	74
7 • Using System Tools	
Import Graphics	76
Delete Imported Graphics	78
Import Fonts	79
Installing Firmware Upgrades.....	80
8 • Maintenance	
Removing Power and Media from Printer.....	81
Cleaning the Printer.....	83
Cleaning Residue from Printer and Keyboard	83
Cleaning the Touch Screen	83
Cleaning the Cutter Blade	84
Cleaning the Sensors	86
Cleaning the Cutter Blade Exit Area	87
Dust Cleaning	88
Cleaning the Printhead	88
Replacing the Media Wiper	89
Clearing Jams	90
Clearing a Printer Jam	90
Clearing a Cutter Jam	91
9 • Troubleshooting	
A • Glossary of Terms	
B • Character Mapping and IME for Asian Text	
Character Mapping	99
Americas QWERTY	99
European AZERTY	100
European QWERTZ	101
European QWERTY	102
European Cyrillic	102
Using the Input Method Editor (IME).....	103
Chinese Simplified	103
Chinese Traditional	105
Korean	106
C • Specialty Label Types	
Pipe Markers.....	108
Set Up Pipe Marker Options	108
Create Pipe Marker Labels	109
Save, Open or Delete a Pipe Marker Label	116

PreMade Labels - North America	117
Creating PreMade Labels	117
PreMade Labels Reference Images - Europe	118
PreMade Labels Reference Images - North America	118
Right to Know (RTK)	133
Setting RTK Preferences	133
Create RTK Labels	137
Open, Save or Delete an RTK Label	138
GHS (CLP)	140
D • Material / Ribbon Cross Reference	

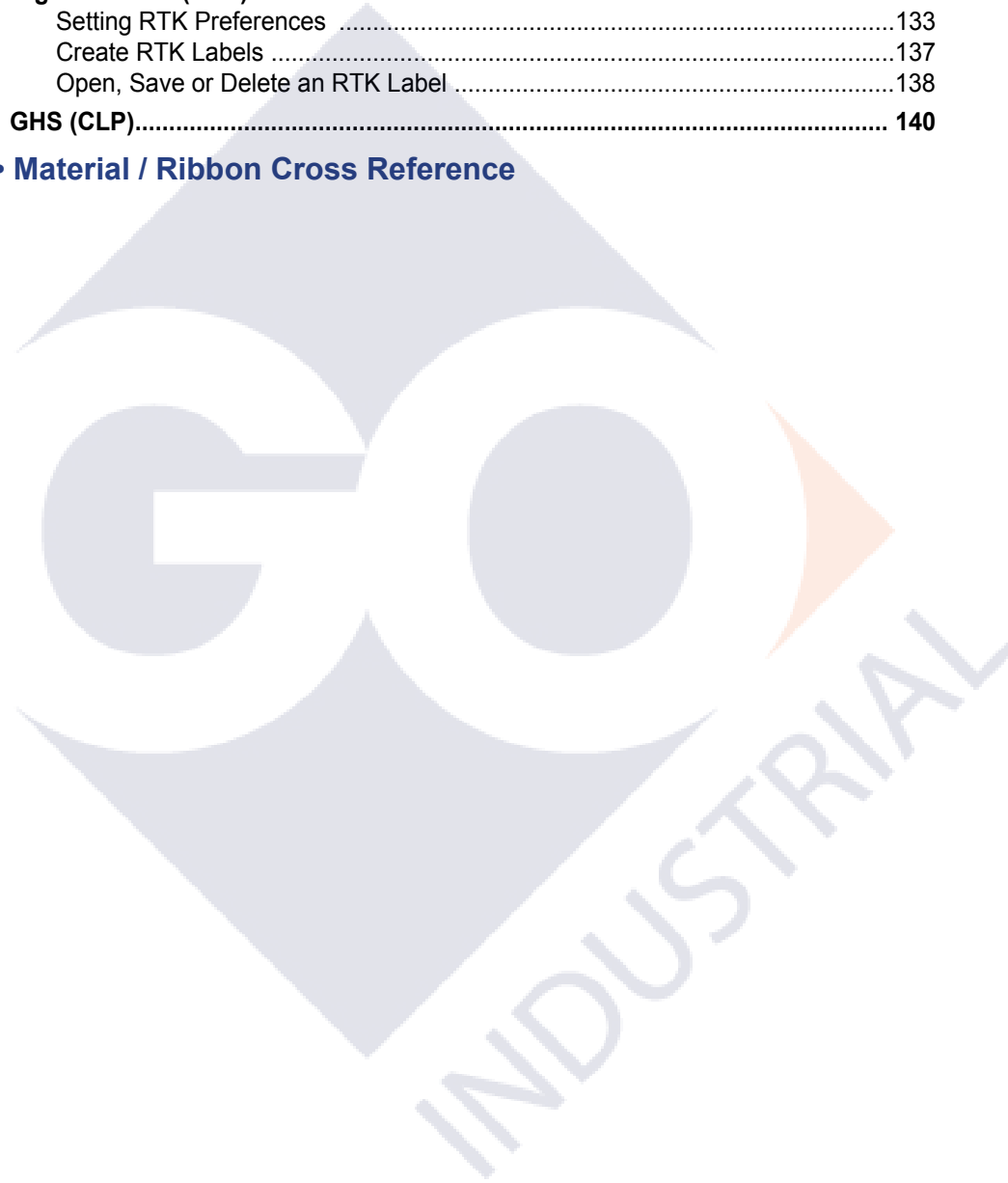

1 Introduction

Thank you for purchasing the BradyPrinter S3100 Sign & Label Printer, which you can use to create and print professional-looking industrial labels and signs. All you have to do is:

- Drop in a ribbon cartridge. You can choose from a wide range of single-color ribbons.
- Drop in a media cartridge. You can choose media in widths that range from 0.5 in. to 4 in. (12.7 mm to 101.6 mm), and come in many colors, styles, and materials.
- Type your text and insert objects or symbols of your choice; or choose a preformatted layout design.

Material and ribbons from Brady Corporation are programmed with the ability to communicate with the printer and software. This allows you to gain the full benefit of the system.

Features and Functions

The following are just some of the features that make this system so easy to use and ready to meet your label-making requirements:

- Small, lightweight (approximately 15 lbs [6.8 kg]) unit, ready for your desktop.
- Color touch screen LCD display, plus keyboard input for ease of use.
- Pre-designed layouts for many standard-use label applications.
- Hundreds of graphics for inclusion on your labels.
- Single-color job printing at 300 DPI, up to 4 in. (101.6 mm) wide and up to 60 in. (1.5 m) long.
- Wide variety of ribbon colors.
- Easy loading label and ribbon supplies.
- Continuous and die-cut label supplies in a variety of high-performance materials.
- Transfer graphics from PC or USB flash drive. Supported graphic formats are Windows metafile (*.wmf) and Bitmap (*.bmp).
- Print labels from PC.
- Automatic cutter.

Compatible Applications

The BradyPrinter S3100 Sign & Label Printer is compatible with Brady® Workstation desktop software.

When used with Brady Workstation software, the printer will automatically recognize all enabled and compatible materials up to 4 in. (101.6 mm) wide. For operation of the printer with other software, refer to the documentation for your application.

Note: Only BradyPrinter S3100 supplies will work with this printer.

System Specifications



- **Weight:** 15 lbs (6.8 kg)
- **Dimensions (stored):** 8.9 in. x 12.0 in. x 9.5 in. (22.6 cm x 30.5 cm x 24.1 cm)
- **Operating Temperature:** 50 - 104°F (10-40°C)
- **Relative Humidity:** 10% to 80% RH non-condensing
- **Storage:** -4 to 122°F (-20 to 50°C) at 15% to 90% RH non-condensing
- **Voltage:** 100 to 240VAC, 50 to 60Hz, 2A
- **Print Resolution:** 11.8 dot/mm, 300 dpi
- **Output media size:** 0.5 in. to 4 in. (12.7 mm to 101.6 mm)
- **Maximum label length (continuous media):** 60 in. (1.5 m)

About Menus, Dialog Boxes and Screens

The following information describes the menus, dialog boxes and screens used in the BradyPrinter S3100 Sign & Label Printer system.

Home Page

The *Home* page automatically displays when you first start the printer. The main sections of the *Home* page are:

	Item	Description
1	Status Bar	Shows the current label size and indicators for the amount of media and ribbon remaining.
2	Tools Panel	Depending on the option selected, provides buttons for Object Sizing, Delete, Undo, Zoom In/Out, and Help.
3	Editor	Text or object entry area. Type, touch or select objects to display and edit in this area. Shows color of installed media and ribbon.
4		Home: Returns you to the <i>Home</i> page from anywhere in the application. Button is greyed out on the <i>Home</i> page.
5	Menu	Displays File, Label and System options.
6		Print: Displays the <i>Print</i> dialog box where you can choose options for printing the current label. Not available unless an object is in the <i>Editor</i> .
7	Control Panel	Primary area for selecting all of your options for creating, editing and working with labels and objects. The panel changes depending on what option is selected.



Tools Panel

The *Tools* panel contains options for editing a label. If no label is selected, the panel contains only the Help button.









The Tools panel contains the following options:

Icon	Description
	Delete: Deletes the selected object (text, barcode or graphic). Only available when an object is selected.
	Undo: Lets you undo a limited number of actions. If there is no undo action available, the undo button is greyed out. There is no redo option available.
	Size: Toggles the display of sizing handles so you can change the size or rotation of the selected object. Only available when an object is selected.
	Help: Context sensitive help that displays information about the selected item or area on the menu.
	Zoom In: Lets you increase the view of the object(s) on the label. Scroll arrows appear if the objects are zoomed larger than the available display area.
	Zoom Out: Lets you decrease the view of the object(s) on the label.

Button Actions

These button actions are used throughout the system. Unless necessary, button actions are assumed to be understood and are not included in the procedures.

- **Help**  : Available at any time by touching the help button.
- **Home**  : Touch from anywhere in the application to return to the *Home* page. You may be prompted to save your current label file.
- **Cancel**  : In most cases, you can press Cancel at any time to return to the previous screen without making any changes.
- **Zoom**: Touch  to zoom in or  to zoom out. Applies to *labels*, not objects.
- **More Options**  : Used throughout the system and lets you choose from additional options that are available for the currently-selected object.
 - **Fonts**: Choose a font type.
 - **Text Features**: Choose one of the text options.
 - **Label Alignment**: Align an object on a label.
 - **Object Framing**: Place a frame around an object.
- **Scroll Arrows**: Display whenever there are more items than can be shown on a screen or menu. There are two types of scroll arrows:

- **Up or Down**  : Use to move through a list of items in a menu.

- **Navigation**  : Use to view all parts of a label.

2 Setting up Your Printer

Unpacking and Setting up Printer

Carefully unpack and inspect the printer surfaces (interior and exterior) and the labeling system for possible damage during shipping.

Note: Be sure to remove any transportation protection from around the printhead and inside the enclosure cover.

What's in the Box

- BradyPrinter S3100 Sign & Label Printer
- Documentation CD including: electronic Quick Start Guide, electronic User's Manual and web links
- Power Cord
- USB Type B Cable
- Printed "Quick Start Guide"
- Cleaning Kit

Note: Please keep the original packaging, including the box, in case the printer must be returned.

System Components



Figure 2-1. Printer Components

- | | |
|--------------------------------------------------------------------------|---------------------|
| 1 Display (with touchscreen) | 2 Sleep/Wake Button |
| 3 Enclosure Cover | 4 Label Exit |
| 5 Media Wiper | 6 Media Guides |
| 7 Media | 8 Cutter |
| 9 Ribbon Cartridge | 10 Ribbon Cover |
| 11 USB Port, Ethernet Port,
Power Switch, and Power
Cord Connector | 12 Keyboard |

Note: The printer is equipped with a universal power supply and can be operated with a supply voltage of 100 to 240 V~, 50- to 60 Hz. The printer senses the voltage type and automatically adjusts for the power source.

Setting up the Printer

Connect Printer Power

To setup the printer:

1. Plug the power cord into the printer at the location shown.
2. Plug the other end of the power cord into an AC power outlet.
3. Turn the power switch on. The printer turns on and displays the Home page. The size and color of the currently installed media and other status indicators are shown.

Note: If there is no ribbon or media installed, the system defaults to black ribbon and 4 in. [101.6 mm] wide continuous white media.



Install or Change Supplies

The media and ribbon supply cartridges use a “smart cell” to define and track the supply information. The system automatically recognizes the supply information for the installed media and ribbon.

Note: The printer can be either on or off when changing supplies.

To install or change ribbon:

1. To remove ribbon, open the enclosure cover (opens from left).



2. Release the latch on the ribbon cover [2] and swing open.
3. Release the ribbon cartridge latch [3] and lift the ribbon cartridge up and out.

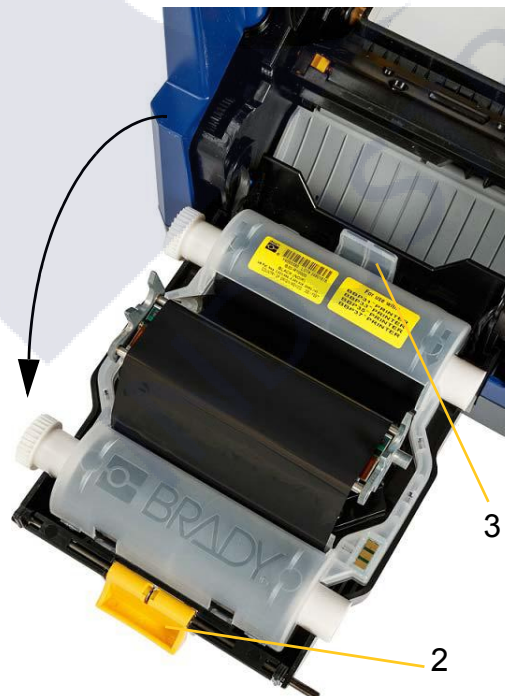

4. Place ribbon cartridge with ribbon over print head (product label toward machine), then snap into place.



5. Close and latch the ribbon cover.
6. Close the enclosure cover.
7. If printer was asleep, press . The system detects the installed supplies, sets media and ribbon colors, indicates the label dimensions and the amount of remaining supplies.

To install or change media:

1. Open the enclosure cover (opens from left).



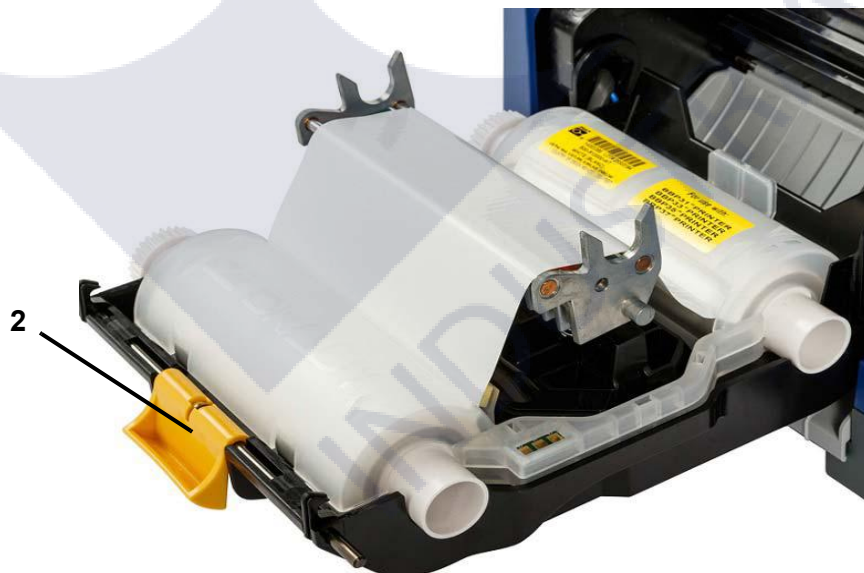

2. Release the latch on the ribbon-cover [2] and swing open.

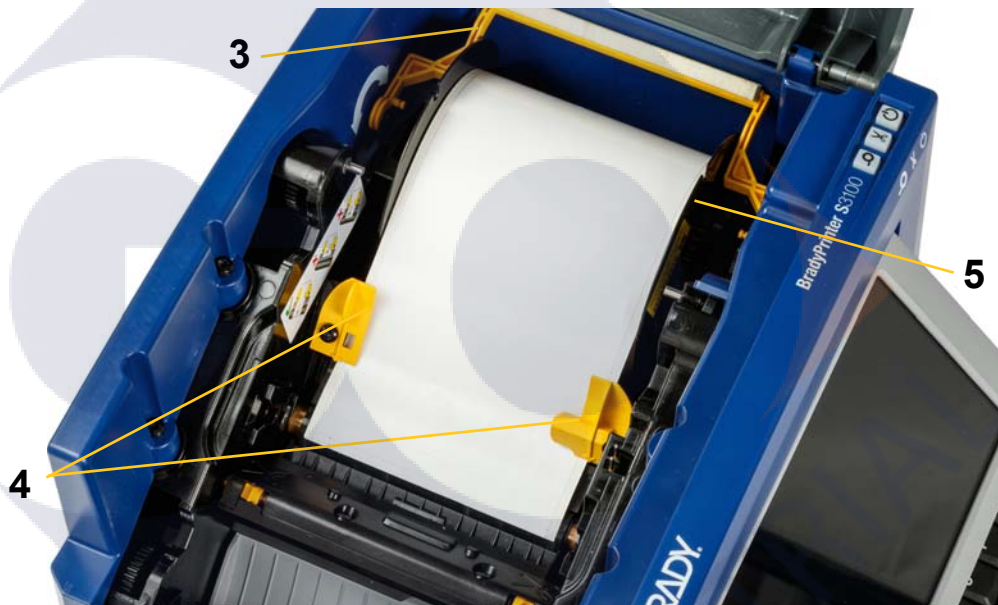

3. Swing yellow media wiper [3] to far right (when facing display), if engaged.
4. Slide yellow media guides [4] to full-open.
5. Remove existing media, if installed, by pulling cartridge from printer.
6. Insert media cartridge until spindle ends rest in slots of media holder [5].
7. Feed media from top of roll until it sits just past the black rubber roller.
8. Close media guides until they touch edge of media liner with media under the guides.
9. Move media wiper into position so it rests on media.

Note: Not all media requires the use of the media wiper. Engage the media wiper only if needed for the supply installed.



10. Close and latch ribbon cover, then close enclosure cover.
11. If printer was asleep, press . The system detects the installed supplies, sets background and foreground colors, indicates the label dimensions and the amount of remaining supplies.

System Power

Starting Printer from a Non-powered (Cold) State

This procedure describes the power-up sequence when starting from a non-powered state (i.e., printer has been unplugged). The printer does **not** retain label data in the editor during a power interruption.

To start the printer from a cold state:

1. Plug the printer into a power source.
2. Turn the power switch on. The system automatically recognizes the supply information for the installed media and ribbon and opens to the *Home* Page.
3. On the *Home* page, continue with your label activities.

Waking the Printer from Sleep Mode

If you do not touch the screen or press any keyboard or other keys/buttons for a defined period of time, the system turns off the display and goes into a low-power consumption mode (see “*Set Clock*” on page 20 for details). The current label and settings are retained.

To wake the printer from sleep mode:

1. Press  or touch the screen. The *Editor* displays the label or menu you were on when the printer went to sleep.
2. Continue with your label activities.

Note: If a label is defined when the system goes into sleep mode and the media is changed to a supply where the label no longer fits, you will be prompted to make the data fit or save the existing label before continuing. If you choose the option to make the data fit, the system will move and/or resize the objects so they fit on the new media size.

Putting the Printer into Sleep Mode

When the system is asleep, the display turns off and the system goes into a low power consumption state but does not require a cold start to turn back on. In this state, you can either touch the screen or press the sleep/wake button to return the system to the same state it was in before going into lower power consumption mode.

Note: To completely shut down the printer, turn off the power switch on the side of the printer.

To put the printer to sleep:

1. With the printer on, press and hold  for approximately two seconds.
2. If there are unsaved changes in the currently active file, you will be prompted to save the current label file.

Resetting the Printer

Use this procedure to reset the printer (e.g., if the screen freezes).

To reset the printer:

1. Press and hold  for at least 5 seconds. The system performs the initialization process and starts the printer. Any data in the *Editor* at the time of the reset will be lost.
2. When the *Home* page displays, you can continue with your label activities.

Using Your Printer with a PC

If you use computer software such as Brady Workstation to create labels, you will need to connect the printer to your computer. (For information on creating labels directly on the printer, see *“Creating Labels” on page 27.*)

Note: You must have labeling software installed on your computer to create, edit or print labels from the PC. Refer to your labeling software documentation for instructions about installing and using the software. See *“Compatible Applications” on page 2* for more details.

You can connect to a computer in one or both of the following ways:

- On a network. This method allows multiple computers to send label files to the printer. See *“Configuring the Printer for Network Communication” on page 15.*
- Directly with a USB cable. See *“Configuring a Direct USB Connection” on page 19.*

Configuring the Printer for Network Communication

The printer has two network controllers - one for Ethernet (wired) and one for Wi-Fi. These two controllers act independently and can simultaneously receive data.

Note: Wi-Fi capability is not available on all printers or in all countries.

You can set up the printer for network communication using:

- An Ethernet connection. Use this option for a wired network. See *“Configuring an Ethernet Connection” on page 15.*
- A Wi-Fi connection. See *“Configuring a Wi-Fi Connection” on page 16.*
- Wi-Fi Direct. Use this option for direct communication between the printer and a Wi-Fi Direct certified mobile device or computer. See *“Configuring a Wi-Fi Direct Connection” on page 18.*

Configuring an Ethernet Connection

1. Touch the **Menu** button at the top of the home screen.
2. Touch the **Setup** button. 
3. On the System Setup dialog, touch **Network**.
4. Touch **Ethernet Address** tab.
5. For *IP Settings*, select either the **DHCP** or **Static** check box.
 - **DHCP:** DHCP addressing is dynamic and the system uses a DNS server to obtain the printer IP address for you.
 - **Static:** For static addressing, you must supply the printer’s IP address.

6. Fill in the following addressing fields if you selected *Static*. Tap the field, type the address, and then touch the **OK** button. 
 - **IP Address:** Enter the printer's IP address.
 - **Subnet Mask:** Enter a subnet mask if you are using one.
 - **Default Gateway:** Enter the IP address of the default gateway.
 - **DNS Server (Primary):** Enter the IP address of the primary DNS server. (Optional)
 - **DNS Server (Secondary):** Enter the IP address of the secondary DNS server. (Optional)

Configuring a Wi-Fi Connection

If configuring an enterprise network connection, you will need authentication certificate files in the root directory of a portable USB storage device (also known as a memory stick or thumb drive).

Note: Wi-Fi capability is not available on all printers or in all countries.

1. Touch the **Menu** button at the top of the home screen.
2. Touch the **Setup** button. 
3. On the System Setup dialog, touch **Network**.
4. Touch **Wi-Fi**.
5. Next to *Wi-Fi Connection*, select the **Enabled** check box. The printer searches for Wi-Fi networks and displays a list of networks found.

Note: Enabling the Wi-Fi Connection will make the Wi-Fi Address and Wi-Fi Direct tabs visible.

Note: If the printer is already configured for Wi-Fi but you want to change networks touch the **Disconnect** button. If you don't see the desired Wi-Fi in the list, touch **Refresh**. The printer will search for available networks and update the list.

6. In the **Wi-Fi Network** list, touch the network to which you want to connect. In the pane to the right of the list, touch **Connect**.
7. Enter the network password and any other requested information depending on the type of network.
 - **Network Name (SSID):** This field is display-only unless you chose *Others* for the network.
 - **Security:** This field is display-only unless you chose *Others* for the network. Enter the type of security used for the network. For example, WEP64 or WPA TKIP.
 - **Authentication Type:** This field is only visible for enterprise networks. Touch **Select**. A list opens. Touch the type of authentication and then touch the OK button.

- **Username:** This field is only visible for enterprise networks.
 - **Password:** Enter the network password.
 - **Certificate Authority, Client Certificate, Client Private Key (Optional):** This field is only visible for enterprise networks. Put the memory stick into the printer's USB port. Touch **Select**. A list opens. Touch the certificate to use and then touch the **Connect** button.
8. On the *Wi-Fi* tab, touch the **OK** button. 

Configuring the Wi-Fi Address

Note: Wi-Fi capability is not available on all printers or in all countries.

1. Touch the **Menu** button at the top of the home screen.
2. Touch the **Setup** button. 
3. On the System Setup dialog, touch **Network**.



Note: Wi-Fi Address will only be visible if Wi-Fi Connection has been enabled on the Wi-Fi screen.

4. Touch **Wi-Fi Address**.
5. For *IP Settings*, select either the **DHCP** or **Static** check box.
 - **DHCP:** DHCP addressing is dynamic and the system uses a DNS server to obtain the printer IP address for you.
 - **Static:** For static addressing, you must supply the printer's IP address.
6. Fill in the following addressing fields if you selected *Static*. Tap the field, type the address, and then touch the **OK** button. 
 - **IP Address:** Enter the printer's IP address.
 - **Subnet Mask:** Enter a subnet mask if you are using one.
 - **Default Gateway:** Enter the IP address of the default gateway.
 - **DNS Server (Primary):** Enter the IP address of the primary DNS server.
 - **DNS Server (Secondary):** Enter the IP address of the secondary DNS server.

Configuring a Wi-Fi Direct Connection



Note: Wi-Fi capability is not available on all printers or in all countries.

Enabling Wi-Fi Direct disconnects any currently connected Wi-Fi connection.

1. Touch the **Menu** button at the top of the home screen.
2. Touch the **Setup** button. 
3. On the System Setup dialog, touch **Network**.
4. Touch **Wi-Fi**.
5. Next to *Wi-Fi Connection*, select the **Enabled** check box.
6. Touch **Wi-Fi Direct**.
7. Next to *Wi-Fi Direct Connection*, select the **Enabled** check box. The printer displays its IP address and network name. When you connect to the printer from your computer or mobile device, you will select this name or IP address.
8. Enter a password for the Wi-Fi Direct network. This is the password you will enter from your computer or mobile device when you connect to the printer.
9. Touch the **OK** button. 

Configuring Other Networks

Configuration for personal or enterprise networks.

1. Touch the **Menu** button at the top of the home screen.
2. Touch the **Setup** button. 
3. On the System Setup dialog, touch **Network**.
4. Touch **Wi-Fi**.
5. If Wi-Fi is disabled, check the box next to Enabled and wait for the Network list to populate.
6. Scroll to the bottom of the list of available networks and select Others.
7. On the Other Network window, choose Personal or Enterprise network and fill in the necessary details.
8. Touch the **Connect** button. 

Configuring a Direct USB Connection

To communicate directly with a USB cable, you will need the USB device driver installed on your PC. Once connected, the PC should automatically detect and install the USB driver, if it is not already installed.

1. Attach the small end of the USB cable to the printer, then the flat end of the cable to the PC.
2. Turn the printer on. On the PC, “*Found New Hardware*” pops up in the lower right corner of the screen and the print driver wizard is launched.
3. In the wizard, click **Install the software automatically** (if it is not already selected).
4. Click **Next**. The print driver installs. This takes a minute or two.
5. When complete, in the wizard, click **Finish**.

The BradyPrinter S3100 printer is now available to receive information from your computer labeling program.

When printing from the PC, the printer must be attached to the PC via the USB cable. Be sure to select the BradyPrinter S3100 printer in the print dialog box of the PC labeling program you are using.



Creating and Printing Labels from a PC

1. Connect the USB cable from the printer to any available USB port on the PC.
2. From your labeling software, print your labels to the BradyPrinter S3100 printer.

Note: You cannot save labels or templates from the PC to the printer.



Setting up the System Defaults

The System Setup function is used to set the printer default settings. Default values are common settings that are pre-assigned to make the system usable as soon as power is applied (e.g., date and time are set to your local date and time). By changing the defaults, you can set the settings to your specific requirements.

To change setup functions use the following procedures. Any defaults set here will stay in effect even when power is removed from the printer, and during upgrades.

Set Clock

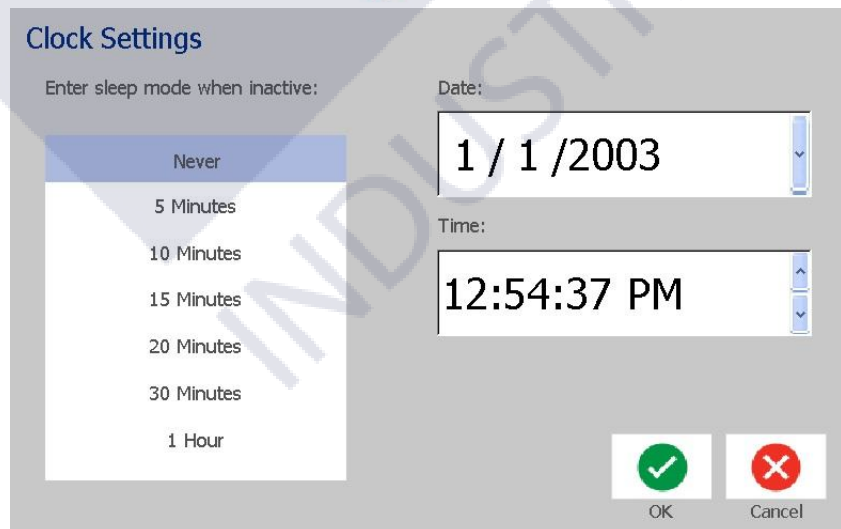

To set date, time and sleep mode:

1. Touch the **Menu** button.
2. In the menu list, touch the **Setup** button. 
3. In the *Setup* menu, touch the **Clock Settings** button.
4. In the *Clock Settings* popup, change any of the following options (this also sets the system clock, which is needed if you want a time stamp on your label):
 - **Sleep mode timeout:** Choose the amount of time you want the system to wait before entering sleep mode.
 - **Date:** Touch to highlight the *Month*, *Day* or *Year*, then touch the ▼ arrow to choose from the calendar display.
 - **Time:** Touch to highlight the *Hour*, *Minute* or *Second*, then touch the ▲ or ▼ arrows to change the time. Touch *AM/PM* to toggle between AM and PM.
5. When done, touch the **OK** button. 



Localization and Unit of Measure

To choose a language and unit of measure:

1. Touch the **Menu** button.
2. In the menu list, touch the **Setup** button. 
3. From the *Setup* menu, touch the **Localization** button.
4. In the *Language* list, choose the language you want the system to display.
5. Select a **Unit of measure** (Inches vs. Millimeters).
6. When done, touch the **OK** button. 

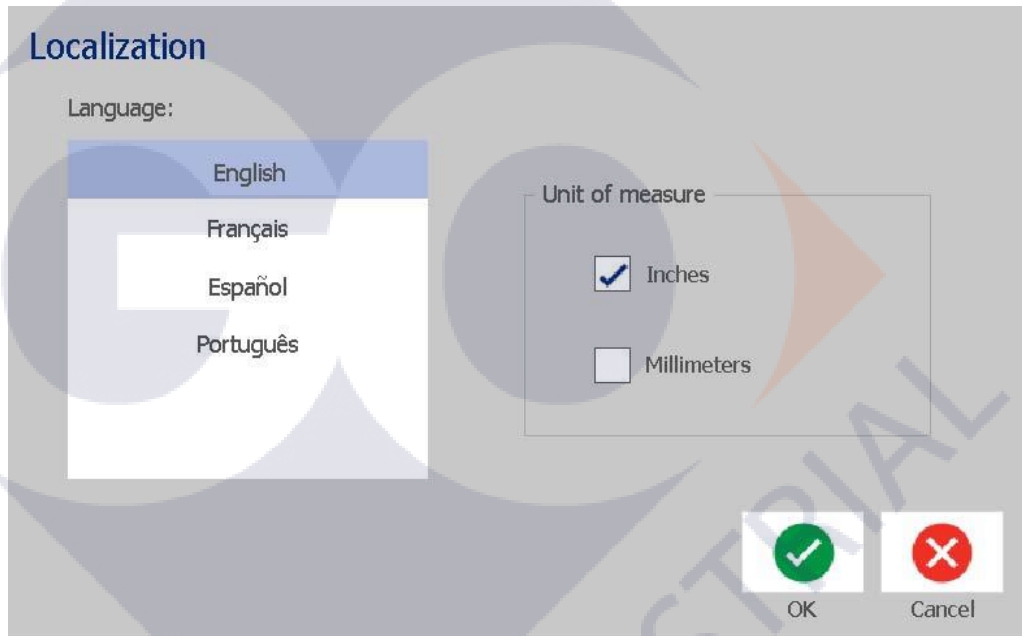

Set Text Defaults

To set the text defaults:

1. Touch the **Menu** button.
2. In the menu list, touch the **Setup** button. 
3. In the *Setup* menu, touch the **Text Defaults** button.
4. In the *Text Defaults* menu, change any of the following options:

Note: Text/object options take effect with the next text object created. Existing text objects are not affected.

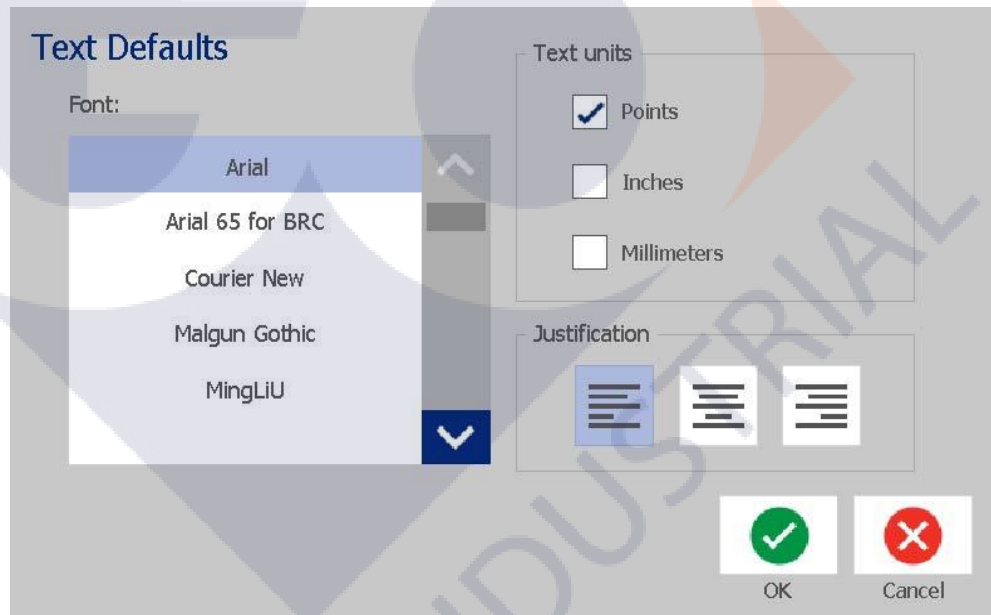

- **Font**
- **Text units**
- **Justification**

5. When done, press the **OK** button. 



Set Barcode Defaults

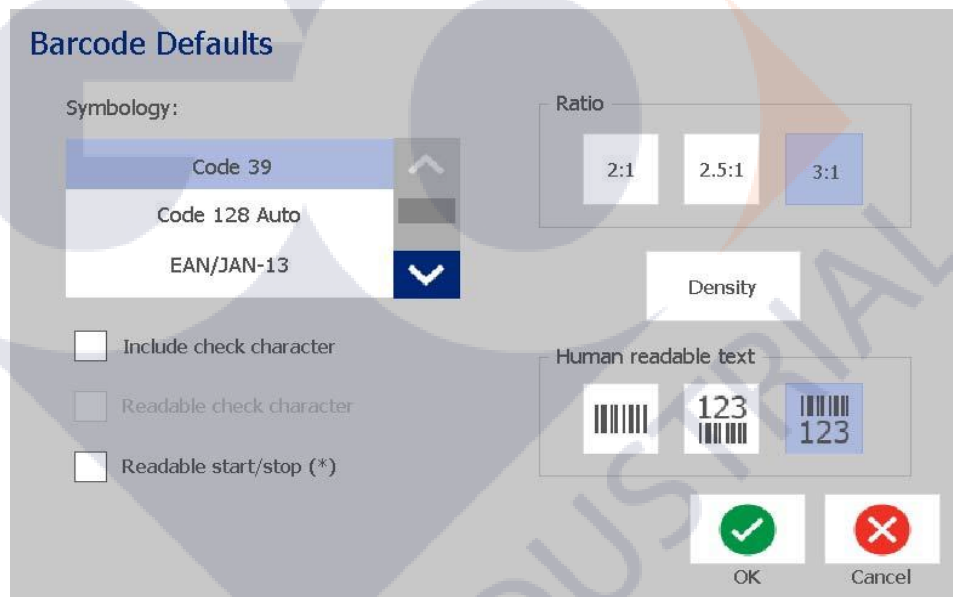

To set the barcode defaults:

1. Touch the **Menu** button.
2. In the menu list, touch the **Setup** button. 
3. In the *Setup* menu, touch the **Barcode Defaults** button.
4. In the *Barcode Defaults* menu, change any of the following options:
 - **Symbology**
 - **Check Characters**
 - **Ratio**
 - **Density**
 - **Human readable text**
5. When done, touch the **OK** button. 



Set Printing

To set the printing defaults:

1. Touch the **Menu** button.
2. In the menu list, touch the **Setup** button. 
3. Touch the **Printing** button.
4. In the *Printing* dialog, change the **Auto cut settings** to your desired option and choose whether or not to print a boundary around the label.
5. When done, touch the **OK** button. 

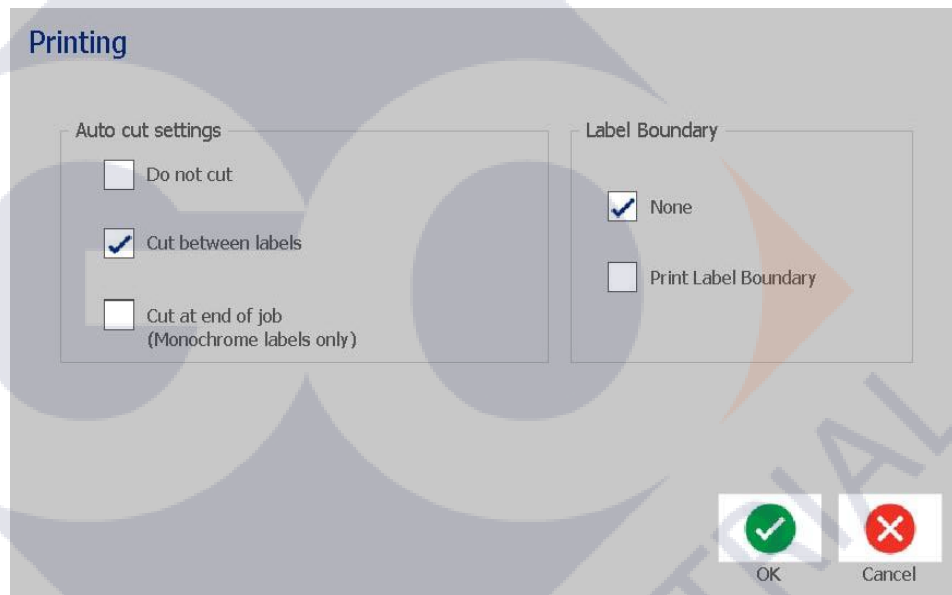

Customizing Home Page Defaults





You can choose which three label types to display on your Home page. The selected label types will be set as the default on your printer.

The *Preview* area will immediately reflect the changes.

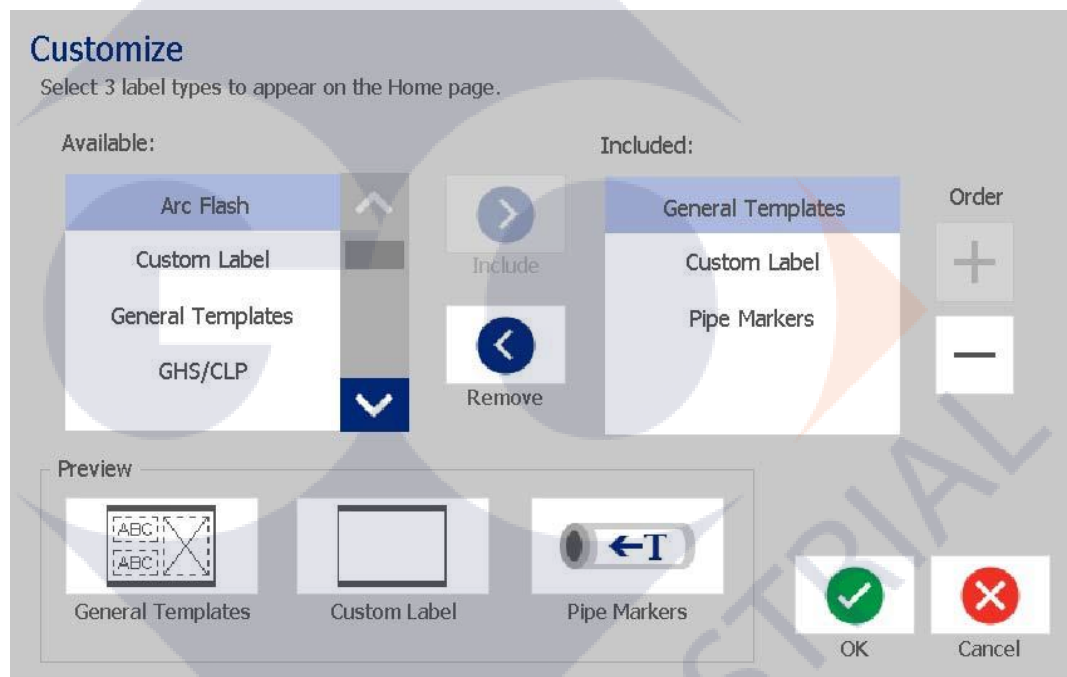
To select label type defaults:

1. From the *Home* page, touch the **More Label Types** button.
2. From the *Label Types* dialog, touch the **Customize** button. The *Customize* dialog box opens.



3. From the *Included* list, select a label type you do not want displayed, then touch the **Remove** button. 
4. From the *Available* list, select a label type to include and then touch the **Include** button. 
5. If desired, change the display order by pressing one of the **Order** buttons. 
6. When done, touch the **OK** button. 

Displaying System Information

Use this procedure to view additional information about the system, such as the current software or firmware version and the available memory.

To view system information:

1. From the *Editor*, touch the **Menu** button.
2. In the menu options list, touch the **Info** button.  The *System Information* dialog box displays.



3. Touch the **Cancel** button  when you are done viewing the system information.

3 Working with Labels

Creating Labels

Creating your first label on the BradyPrinter S3100 Sign & Label Printer is as easy as starting to type! You don't need special software and you don't have to be connected to a PC to create or print labels.

Creating a Text Label

This procedure describes how to create a text label with minimal formatting, using basic editing techniques, and printing the label.

Note: Take advantage of the powerful label creation and editing capabilities by using the pre-designed layouts, templates and graphics included with the BradyPrinter S3100 Sign & Label Printer. See the procedures in this manual for detailed instructions.

To create a text-only label:

1. From the *Home* page, start typing.
2. To create another line in your text object, press **Enter**.
3. To change the look of your text, you can select any of the available font or text attributes that display in the *Control Panel* as soon as you start typing.

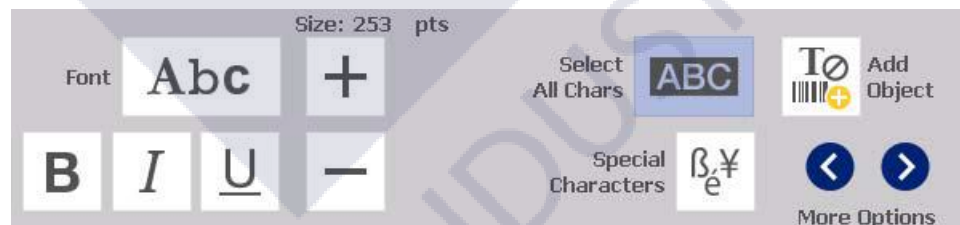

To print your label:

1. When you are done creating your label, touch the **Print** button.



Note: The printer must have ribbon and tape installed before you can print.

2. In the *Print* dialog box, type the number of copies you want to print.
3. Touch the **Start Print** button. 

Creating a Label from a Template

Use this procedure to create a label using a general template or specialty template.

To create a label from a general template:



1. From the *Home* page, touch the **General Templates** button. 
2. On the *Select Template* dialog box, touch a **Category**.



3. Choose a template from the list of available templates. The label is displayed in the *Editor* with the objects scaled to fit the installed media.
4. To choose a different template, touch the **Change Template** button.

Notes:

- Once you have defined data for at least one of the objects, the option to change the template is no longer available.
- If there are unsaved changes in the currently active file, the system will prompt you to save the file before continuing.

5. In the *Editor*, select an object using one of these methods:
 - **Screen:** Touch the object.
 - **Keyboard:** Press the **Tab** key to move to the next object.
 - **Buttons:** Touch the **Next Object** button  (only available if there are undefined placeholder objects).
6. **To enter text**, select a text object and start typing. You can change the look of your text by selecting any of the available font or text attributes that display in the *Control Panel* as soon as you start typing
7. **To change a barcode**, touch the barcode object and change any of the options in the *Barcode* dialog box.
8. **To change a graphic**, touch the graphic object and choose from any of the available graphics in the *Select Graphic* dialog box.
9. **To add an object**, touch the **Add Object** button  (if available) and choose from any of the available object types.

Note: You can only add more objects to the label if all template objects have been defined.

10. Continue selecting objects and entering data until all objects are defined.

Creating a Custom Label

Use this procedure to create a label without using a predefined template.

To create a custom label:

You can add objects to a label with the *Add Object* button.

1. From any screen, touch the **Add Object** button  to add an object to the label.
2. In the *Add Object* menu, touch a button to add an available object type.



Note: The object is placed on the label at a default size and position that varies depending on the dimensions of the label.

3. To add another object, touch the **Add Object** button  again, or touch a blank area on the label, then choose the object type you want to add.

Note: If the label is full and there is no place to add a new object, the object will be placed at the right-most edge of the label and you will have to move and/or resize it.

Note: See “*Specialty Label Types*” on page 107 for creating other label types.

Set Label Attributes

Creating Fixed-Length Label

Use this procedure to create a label where the continuous-media label length is set, not variable. Once selected, the printable area shown on the label is reduced by the amount of the leader/trailer required for the installed supply, so that the total label length output matches the selected length.

Note: The label size for die-cut media is already set and cannot be adjusted.

To create a fixed-length label:

1. From the *Home* page, touch the **Menu** button.

2. In the menu list, touch the **Size & Orientation** button.

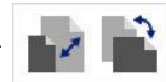

Note: You can also access the *Label Size & Orientation* box by touching the **Label Size** text at the bottom of the screen.

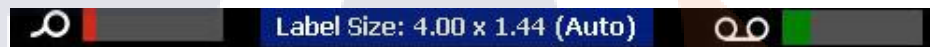

3. On the *Label Size & Orientation* dialog box, select the **Fixed Length** check box.
4. In the field to the right of the *Fixed Length* check box, enter the desired label length.

Note: Minimum supported length is 0.5 in. (12.7 mm). Maximum supported length is 60 in. (1524 mm).

5. Touch the **OK** button. The *Status Bar* indicates the new label length.

Creating Auto-Sized Label

Use this procedure to create a label where the continuous-media label length adjusts to fit the data that you add to the label (variable label length).

Note: The label size for die-cut media is already set and cannot be adjusted.

To create an auto-sized label:

1. From the *Home* page, touch the **Menu** button.

2. In the menu list, touch the **Size & Orientation** button.





3. Select the **Autosize to Fit Data** check box. When entering data, the label size will automatically be adjusted to fit the data.

4. Touch the **OK** button.

Orientation

Use this procedure to set the label in either portrait or landscape orientation. You can change the label orientation even if you are working on a label in the *Editor*.

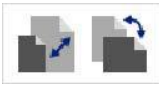
To set the label orientation:

1. Touch the **Menu** button.
2. In the menu list, touch the **Size & Orientation** button. 
3. Under *Label Orientation*, touch one of the orientation buttons to choose the orientation of your label:
 - **Portrait** : Length from top to bottom.
 - **Landscape** : Length from left to right.

Note: If the current data will not fit on the selected length, you will be prompted to have the system make the data fit, or cancel the change. If you choose to make the data fit, the objects will be moved and/or resized so they fit on the label; however, the objects will **not** be rearranged into a new orientation.

4. Touch the **OK** button. 

Label Width

You can adjust the width of the installed media to accommodate up to 4 labels printed in the space of the adjusted width. Adjusting the width automatically changes the size of the font and the margins. In this function, label width also addresses the height of the label, measured from top to bottom. For instance, if using 4-inch tape, when you select *2 Up*, two labels would be stacked and printed on the tape, each taking up 2 inches. If you select *3 Up*, three labels would be stacked and printed on the tape, each taking up approximately 1.333 inches. The fourth label would be printed trailing the first label.

Label Text 1	Label Text 1 Label Text 2	Label Text 1 Label Text 2 Label Text 3	Label Text 1 Label Text 2 Label Text 3 Label Text 4
Label Text 2	Label Text 3 Label Text 4	Label Text 4	
Label Text 3			
Label Text 4			
Match media size	Label width - 2 UP	Label width - 3 UP	Label width - 4 UP

Figure: Stacking labels using 2-, 3-, or 4-Up label width

To adjust the width:

1. Touch the **Menu** button.
2. Under *Label*, touch the **Size & Orientation** button. 
3. Under *Label Width*, touch the **Set Label Width** button.

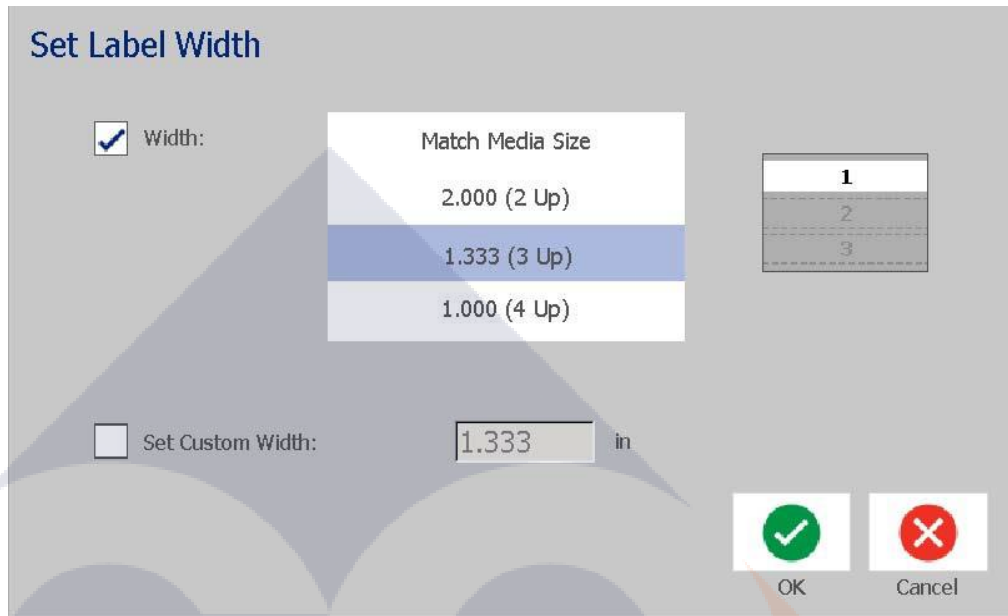

4. In the *Set Label Width* dialog box, make sure **Width** is selected, and then touch the desired width. (Observe the preview panel on the right side of the screen to view how the labels will print.)

You can also set a custom width. Setting a custom width disables the 2- 3- and 4-Up function. To set a custom width:

- a. Touch **Set Custom Width**.
- b. In the *Set Custom Width* data field, enter the desired width.
- c. When finished, touch the **OK** button. 

Framing a Label

Note: When printing with frames around the labels, be sure the media guides fit snug against the media so the tape does not shift while printing. For making fine adjustments to the frame, see “Adjusting Print Offset” on page 71.

Use this procedure if you want to place a frame (border) around the **entire** label. The following conditions apply:

- **Fixed-size labels:** When using continuous or die-cut supplies, the frame is applied to the *outer* perimeter of the printable area. If changed, the frame size changes with the label size.
- **Auto-sized labels:** When objects determine the label length, the frame is sized to fit the objects on the label *when the frame is applied*. If the label size changes after that, the frame is **not** resized. You must reapply the frame to the label after making a size change.

To place a frame around the label:

Note: If you are not working with a fixed-length label, you must have at least one object on your label before you can place a frame around the label.

1. Touch the **Menu** button.
2. In the menu list, touch the **Frame** button. 
3. From the *Label Frame* menu:
 - a. Select the frame shape (none, rectangle, rounded rectangle).
 - b. Select the frame line width (narrow, medium, wide).



Note: Line width options are available *only* when the rectangle or rounded rectangle frame shape is selected.

4. When your changes are complete, touch the **OK** button . The changes are applied.



Tools

Zooming the Label View

To zoom a label view:

1. Touch  to zoom in or  to zoom out.
2. Touch the zoom control again, as necessary, until you reach the desired zoom level.

Note: If all of the label objects cannot be displayed on the screen, the scroll arrows display. See “Scrolling the Label View” on page 36 for details.

3. Touch   as needed to return to normal viewing mode.

Scrolling the Label View

Use this procedure to view part of the label that is no longer displayed on the screen, either vertically or horizontally, without changing the zoom level.

To view hidden parts of a label:

1. When one or more scroll arrows appear in the *Editor*, touch a scroll arrow to scroll in the direction you want to view. The ruler value updates automatically as the label view changes.

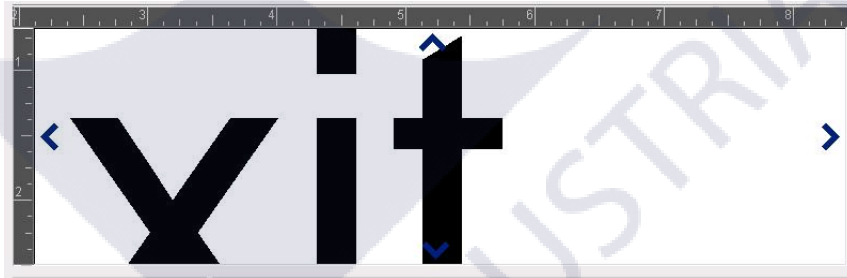

Note: If the entire label is shown on the display, no scroll arrows appear.

2. Touch the scroll arrow again to continue scrolling in the direction you want. If you hold the scroll arrow down, the system will continue scrolling.
3. To return to normal viewing mode, touch  until you can see the entire label content.

4 Working with Objects

An object can be any text, graphic or barcode element on a label. Objects can be edited, moved, aligned, deleted, rotated, framed and/or sized. Some objects also have characteristics that can be added or changed (e.g., bold, justified, underlined, density).

Object Types

Object types include Text, Graphics, Barcodes, Serialization, and Date/Time. To add objects:

- **Touch the *Editor* screen:** Inserts a placeholder object which you can then populate with any of the object types.
- **Touch Add Object button** (located in the *Control Panel*): Inserts a placeholder object which you can then populate with any of the object types.
- **Add Empty Object** (when at the *Add Object* panel): Touching an empty area of the label will create a placeholder object at the location you touched. The object type you create will then insert into the placeholder object.

Object Sizing

The system automatically reduces the object size to fit on the label and will move or resize the object so it stays within the printable area of the label (text will not be truncated).

Adding Objects

The easiest way to add an object is to touch a blank area of the *Editor*. If you are currently editing an object, touch the screen twice, once to deselect the current object and once to insert a new object.

You can also add objects using any of the following the methods.

Text Objects

To add a text object:



1. Use one of the following methods to add a text object:
 - **Start typing:** A text box is added and filled with the typed text. If there are already placeholder objects in the *Editor*, the text will be added to the first available (empty) placeholder.
 - **Touch a blank area of the screen:** A text box is added and any typed text will be added to that object.
 - **Select Add Object:** Touch the **Text** button . A text box is added and typed text will be added to that object.

Note: As soon as a text object is selected, the system goes to the text editing panel and you can type and/or edit the text.

2. To edit the text, see “*Working with Text*” on page 46.

Graphic Objects

To add a graphic object:

- Use one of the following methods to add a graphics object:
 - Touch anywhere in the *Editor*.
 - If you are already in a label, touch the **Add Object** button. 
- In the *Add Object* panel, touch the **Graphic** button. 
- In the *Select Graphics* dialog box, choose the **Category** for the graphic you want to add.
- Touch the desired graphic. The graphic is added to the label (or replaces the selected graphic placeholder).

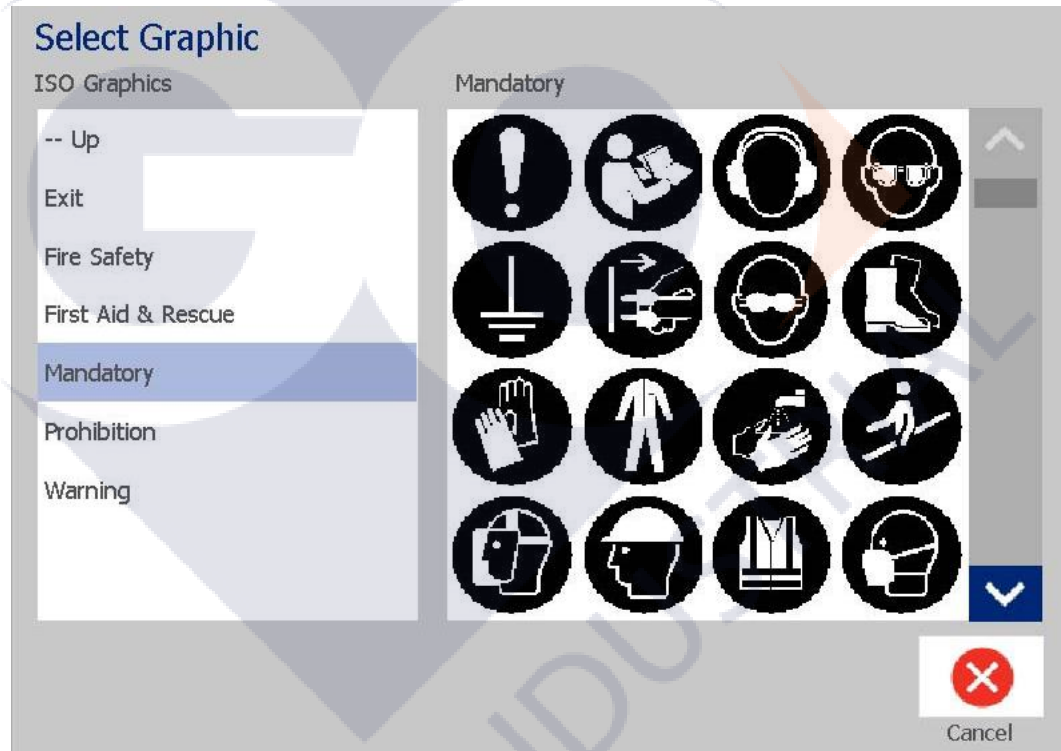

Note: You can also import your own graphics and use them like the graphics included in the system. See *“Import Graphics”* on page 76.

Shapes

Use a graphics object to add a shape, such as a circle or rectangle to your label.

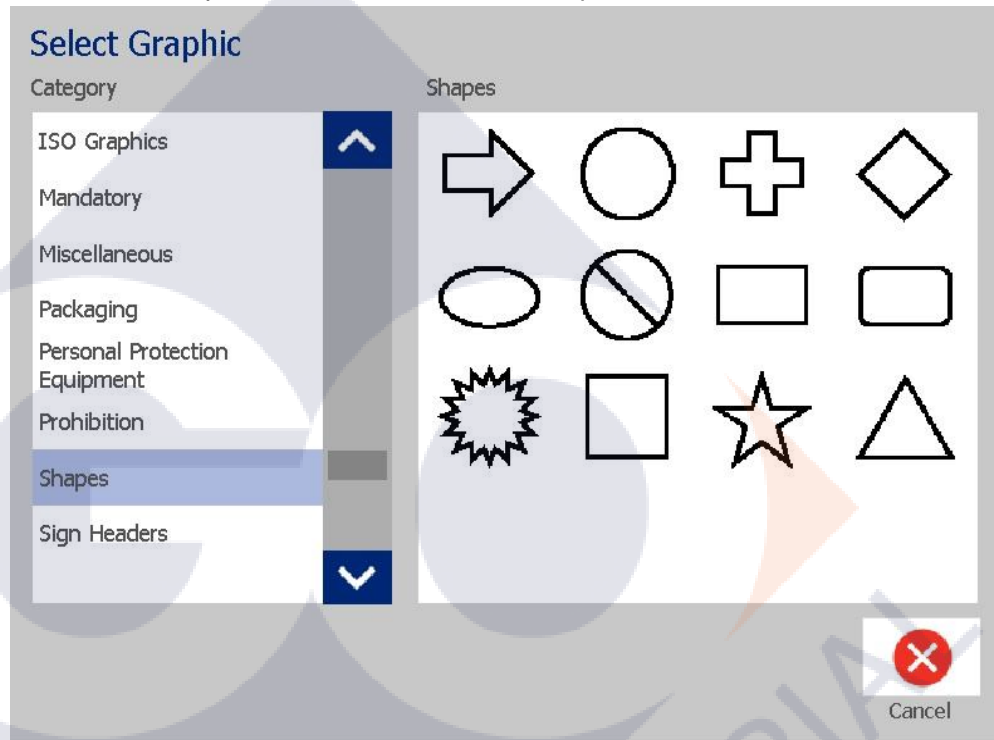

To add a shape to your label:

1. Touch the Editor screen where you want the shape to be added.
2. In the *Add Object* control panel, touch the **Graphic** button. 
3. In the *Select Graphic* dialog box, under *Category*, touch *Shapes*.
4. In the *Shapes* area, touch the desired shape.

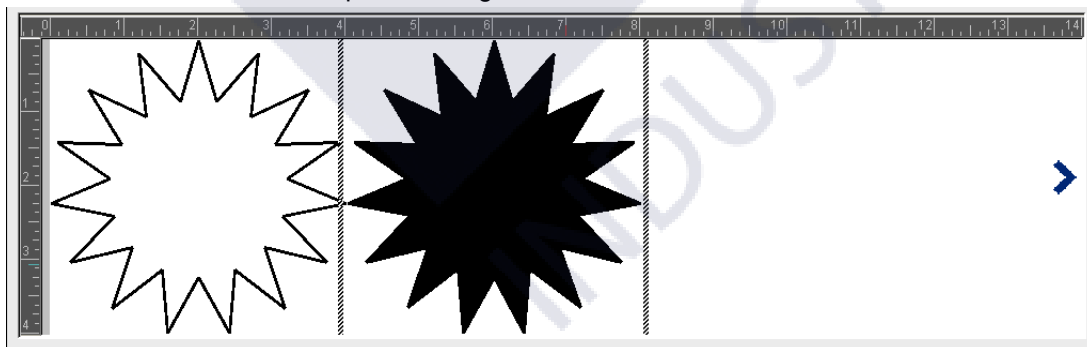

5. The shape is displayed in the Editor. Decide whether you want the shape filled in or outlined. The following image shows an outlined shape on the left and a filled in shape on the right.



- To fill in the shape touch the **Fill** button. 
- To outline the shape, touch the **Outline** button. 

Barcode Objects

For information on what a barcode is and on editing an existing barcode, see *“Working with Barcodes” on page 54.*

To add a barcode object:

1. Use one of the following methods to add a barcode object:

- Touch anywhere in the *Editor*.
- If you are already in a label, touch the **Add Object** button.



2. In the *Add Object* panel, touch the **Barcode** button.



3. In the *Barcode Content* dialog box:
 - a. Select a barcode **Symbology**.
 - b. Type a **Data Value**.

Note: You can set a different symbology as the default by using *System Setup* (see *“Set Barcode Defaults” on page 23*).

Note: To set a different data source, see *“Converting Text or Barcode to Variable Data” on page 64*.

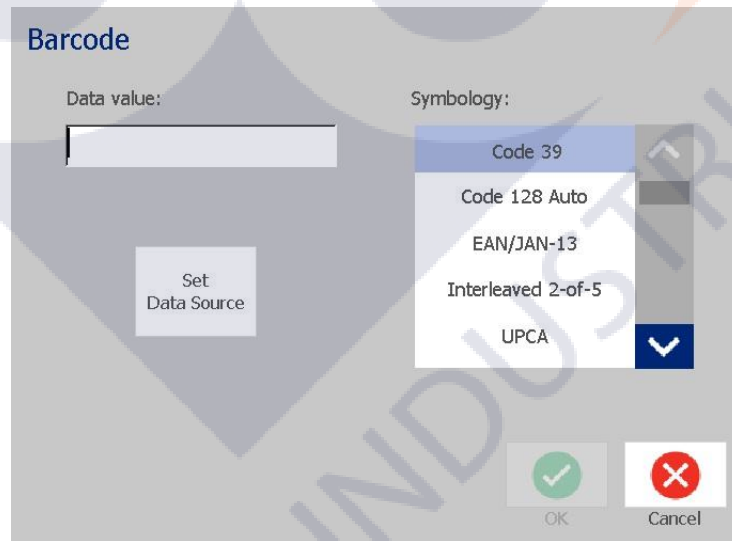

Note: If a typed character is invalid for the active symbology, a message will display indicating that you have entered an incorrect character. Options for entering barcode data and selecting symbology will remain displayed until valid characters are entered or you cancel the operation.

4. Touch the **OK** button.

Serial Objects

Serialization lets you create labels that contain number or letter sequences that print as multiple labels at print time.

Note: This procedure applies only when **not** using a template. If using a template, see “*Converting Text or Barcode to Variable Data*” on page 64.

To add a serial object:

1. Touch the **Add Object** button.



2. In the *Add Object* panel, touch the **Serial & Date/Time** button.



3. In the *Serial & Date/Time* dialog box, select either:
 - **Serial Text**
 - **Serial Barcode**
4. In the *Serial* dialog box, type or select values for setting the serial attributes (the *Sample* area will immediately display an example of the selections):
 - **Starting Value:** Starting label value for the serialization to begin. Can use alpha or numeric (positive or negative) values.
 - **Ending Value:** Ending label value for the serialization to stop (not used if Total Number of labels is entered). Can use alpha or numeric (positive or negative) values.
 - **Change by:** Number that the serial value increments or decrements for each label. Can use positive or negative values.
 - **Total number:** Number of labels that will be printed (not used if Ending Value is entered).
 - **Before serial:** Prefix (text or spaces) before the serial value.
 - **After serial:** Suffix (text or spaces) after the serial value.

Serial

Starting value: Ending value:

Change by: Total number:

Before serial:

After serial:

Sample



- When done, touch the **OK** button . The system displays the initial (first) value of the serialization on the label.

Date/Time Objects

The Date/Time option lets you place a time stamp on your label (text or barcode). Depending on the options you choose, you can add a date, time or date *and* time.

You can change the clock settings at any time by selecting **Clock Settings** (see “Set Clock” on page 20, starting at Step 4 for more details).

To add a date/time object:

1. Touch the **Add Object** button. 
2. In the *Add Objects* panel, touch the **Serial & Date/Time** button. 
3. In the *Serial & Date/Time* dialog box, select:
 - **Date/Time Text:** Places a date/time object on your label.
 - **Date/Time Barcode:** Places a barcode object with date/time data.
4. In the *Date/Time* menu, select the format(s) you want included on the label. The *Preview* area immediately displays the changes.

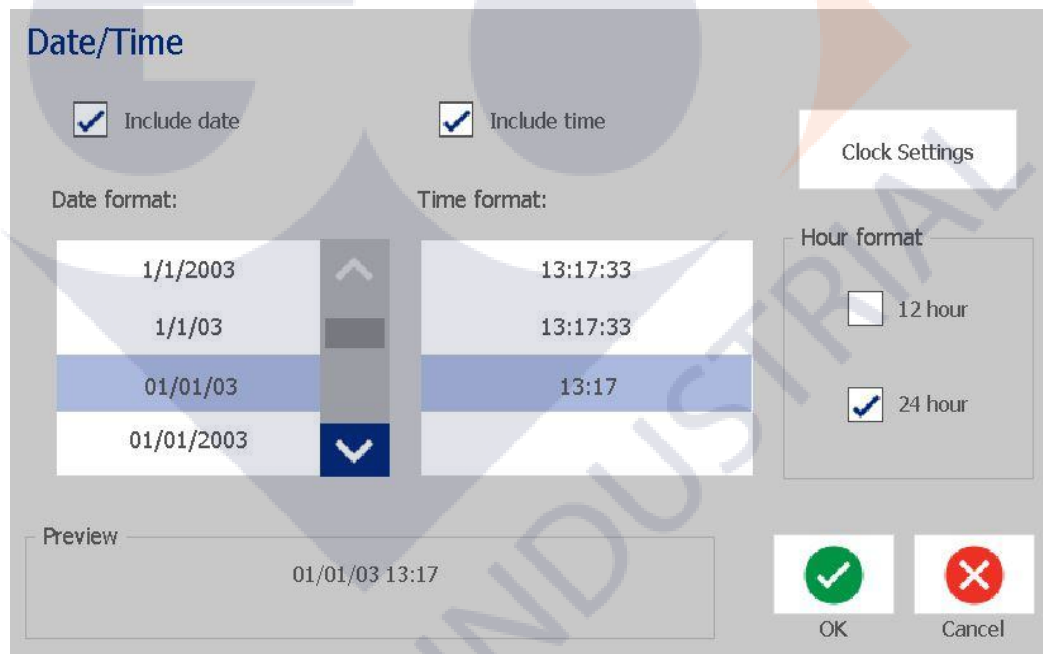

- **Include date:** Toggles the date on or off.
- **Include time:** Toggles the time on or off.
- **Date Format:** Format for date printed on label(s).
- **Time Format:** Format for time printed on label(s).
- **Hour Format:** 12-hour (AM or PM) or 24-hour time format

5. When done, touch the **OK** button  . An object with the current date/time value is added to the label.

Note: When printed, the date/time value of each label will reflect the *current* date and time of the printer.

Note: If the system clock has not been set, the system displays a message requesting that you set the system clock. Selecting **OK** takes you to **Clock Settings**. Selecting **Cancel** returns you to the *Editor*.



Working with Text

Selecting or Deselecting Text

To select or deselect words in a text box:

1. In the *Editor*, touch the words you want to select:
 - **Select a single word:** Touch the word. The system highlights the word.
 - **Extend the selection:** Press *Shift* and touch another word in the same text object. The system highlights the additional word(s).
 - **Deselect a word:** Touch the highlighted word. The system deselects the word. If more than one word is highlighted, the system deselects everything *except* the word that was touched.

To select individual characters in a text box:

1. In the *Editor*, choose the object with the character(s) you want to select.
2. Touch the area where you want the selection to start (or use the keyboard ← or → arrow keys).
3. On the keyboard, hold **Shift** and press the ← or → arrow keys to move the cursor to the position where you want the selection to end.

Note: Until **Shift** is released, the selection will be extended by one character each time you press an arrow key.

To select all characters in a text box:

1. In the *Editor*, touch a text object.
2. Touch the **Select All Chars** button . The system selects all characters in the text object.

Increase or Decrease Text Size

When you change a character-level attribute, any highlighted text will reflect the change **and** new text following the current cursor position will also reflect the change. You can grow or shrink the text sizing by this procedure.

To increase text size:

- Type text into a text box. The text will automatically size to fit the size of the text box or as it reaches the label boundary.
- Touch or select a text box and then in the *Control Panel*, touch  .
- See also “*Changing Character Font, Size or Style*” on page 48.

To decrease text size:



- Press **Enter**. A new line will be started and the text size decreased to fit the text box.
- Touch or select a text box and then in the *Control Panel*, touch  .

Delete/Clear Text

To delete/clear text in a text box:

1. With a text label in the *Editor*, touch a text object. The cursor (blinking) is positioned at the end of the text box.
2. To delete or remove text, use these keys on the keyboard:
 - **Backspace**: Deletes character(s) to the *left* of the cursor:
 - **Highlighted Characters**: If characters are highlighted, pressing *Backspace* deletes all of the highlighted text.

Note: Pressing **Enter** deletes any highlighted text *and* starts a new line.

3. To clear all text and leave the text box:
 - a. Touch the **Select All Chars** button. 
 - b. On the *Keyboard*, press **Backspace**. Removes the highlighted text.
4. To delete all text and remove the text box, touch the **Delete** button  in the *Tools* section. All text in the selected text box is deleted *and* the text box is removed.

Changing Character Font, Size or Style

Character-level attributes are those that affect a single character or characters in an object (e.g., The "T" in the word Text). Character-level attributes include font, font size and font style (bold, italic and underline).

When you change a character-level attribute, any highlighted text will reflect the change **and** new text following the current cursor position will also reflect the change.

To change a character font, size or style in the Text Attributes control panel:

Note: When you change the text attributes from the control panel, the changes are immediately reflected in the *Editor*. Any subsequent changes will also reflect this change.

1. In the *Editor*, select a single character or characters from the text box.
2. In the *Text Attributes* control panel:
 - Touch the **Font** button , then select the new font type and touch the **OK** button.
 - Touch any of the following buttons: .

To change a character font, size or style in the Fonts dialog box:

1. In the *Editor*, select a single character or characters from the text box.
2. In the *Text Attributes* controls, touch the **Fonts** button.
3. In the *Fonts* dialog box, select or change any of the following attributes:
 - **Fonts:** Select from the list of available fonts.
 - **Size:** Type a size for the text. Any highlighted text will change to the new size and new text following the current cursor position will also reflect the change.
 - **Style:** Select Bold, Italic and/or Underline (also see *"Increase or Decrease Text Size" on page 47*).
4. When you are done, touch the **OK** button.



Horizontal Text Justification

Use this procedure to set or change how text is horizontally aligned within the object. This primarily affects text objects with multiple lines; the alignment setting is either at the left edge, center, or right edge of the object.

Note: Horizontal alignment affects the way the text grows as characters are added. Left-justified text grows to the right, center-justified text grows both directions and right-justified text grows to the left.

To set text horizontal justification:

1. In the *Editor*, select the text object you want to change.

2. If not already displayed, touch the **More Options** button  to go to the *Justification* controls.
3. Touch the desired justification option (left, center, right) . The text is immediately displayed and justified to the new setting.



Note: Text objects can all be formatted with different alignments, however the last text object set becomes the default for any new text objects during the current editing session. See “*Set Text Defaults*” on page 22 for more details.

Vertical Text

Use this procedure to align text vertically as a string of characters.

Once text has been sized to fit vertically, selecting the vertical setting again will not change the text back to the original size. You will have to manually change the text size back to its original setting.

To set text vertically:

1. In the *Editor*, select the text object you want to change.
2. In the *Control Panel*, touch the **More Options** button  to navigate to the *Vertical* controls.
3. Touch the **Vertical** button . The text is immediately displayed vertically on the label.
4. To toggle the vertical setting on and off, touch the **Vertical** button  again.

Notes:



- Line breaks in the text are treated as spaces when the text is formatted vertically.
- If the vertical object does not fit on the label, the object and text will be resized so it fits within the printable area of the label (i.e., text is not truncated).

Expanding or Condensing Text

Use this procedure to expand or condense the text characters horizontally. This does not change the font size.

To expand or condense text:

1. In the *Editor*, select the text object you want to expand or condense.
2. In the *Control Panel*, touch the **More Options** button  to navigate to the *Expand/Condense* controls.

3. Touch the **Expand** button  or **Condense** button . The text is immediately displayed expanded or condensed on the label.



Note: Text expands or condenses 50% to 200% in 10% increments. If the limits are reached, the Expand/Condense buttons have no further effect.

4. Repeat *Step 3* to continue expanding or condensing the text.

Reversing Text

Use this procedure to format text with the foreground and background colors reversed (i.e., black on white background or white on black background).

To set reverse text output:

1. In the *Editor*, select the text object you want formatted in reverse.
2. In the *Control Panel*, touch the **More Options** button  to navigate to the *Reverse* control.
3. Touch the **Reverse** button . The text is immediately displayed with the foreground and background colors reversed.
4. To toggle the setting on or off, touch the **Reverse** button  again.

Typing Text and Accented Characters

As with standard PC keyboards, each character key supports multiple characters when used in combination with the **<Shift>** and **<Alt Gr>** keys.

Keycaps show characters in one of four positions (see Figure Keystroke Combinations). The character position on the physical key indicates how to access the characters with the **<Shift>** and **<Alt Gr>** keys.

Characters that require 2 keystrokes are not differentiated in any way, however, they will respond differently when selected. For example, when an accented character is typed, it will not display until the letter to be modified is also typed. The accented character will then be displayed with the letter.

Understanding Keystroke Combinations

- The term "Key" represents the physical key on which the accent character is located.
- The "+" sign indicates that two or more keys should be pressed simultaneously.
- A comma separating a keystroke combination indicates that the first set of keys should be released before typing the next keystroke combination.

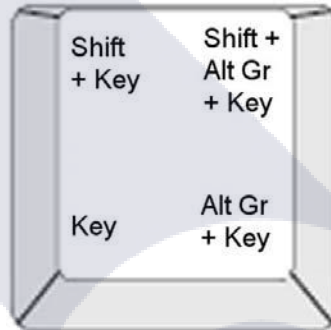

Figure: Keystroke Combinations

Typing Accented Characters

To access accented characters, typing the key combinations may vary depending on the keyboard configuration you are using.

Note: See “Character Mapping and IME for Asian Text” on page 99 for a list of accent characters available with specific keyboards.

To type an accented character:

1. On the keyboard, locate the key with the accented character you want applied.
2. Type the appropriate keystroke combination (see Figure Keystroke Combinations). The table shows example keystroke combinations.

Note: The keyboard configuration used in all of the examples is North American QWERTY, except the ring, which used the European QWERTY.

Result	Accent Key	Keystroke Combination
ç	Cedilla	Lower Case: Alt Gr + Key Upper Case: Shift + Alt Gr + Key
ô à	Circumflex Grave	Lower Case: Shift + Alt GR + Key, Letter Upper Case: Shift + Alt GR + Key, Shift + Letter
é ñ	Acute Tilde	Lower Case: Alt-GR + Key, Letter Upper Case: Alt-GR + Key, Shift + Letter
ä	Diaeresis (umlaut)	Lower Case: Shift + Key, Letter Upper Case: Shift + Key, Shift + Letter
å	Ring	Lower Case: Alt + Key, Letter Upper Case: Alt + Key, Shift + Letter

Entering Special Characters

Use this procedure to enter text characters, such as accented characters or special characters, that are *not* present on the physical keyboard.

To enter special characters:

1. In the *Editor*, choose a text object then touch the **Special Characters** button



. A list of available characters is displayed.

Note: The available characters depend on the font you are using.

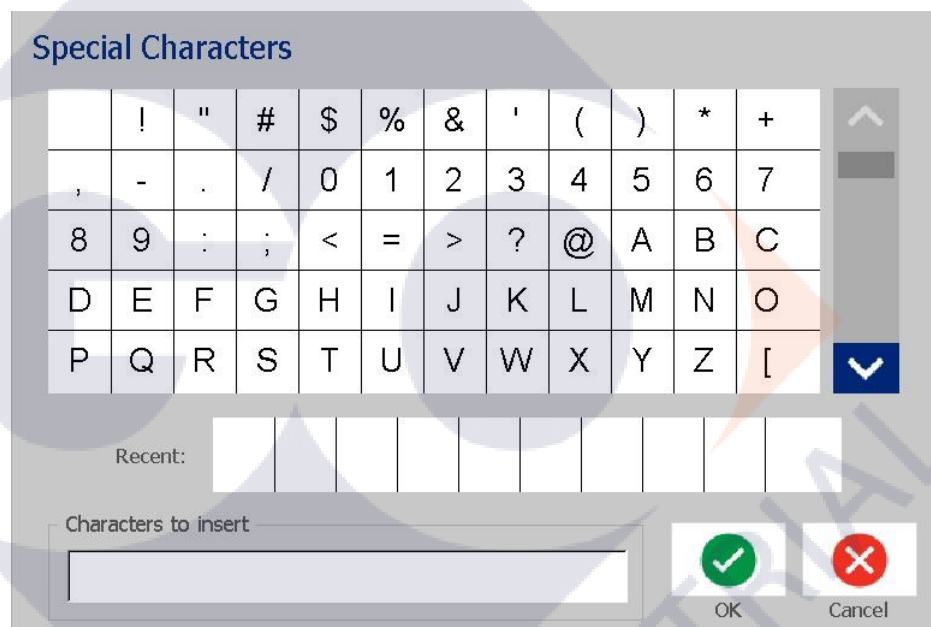

2. Select the character(s) you want to enter (you can select more than one character at a time). The selected character(s) immediately display in the *Characters to Insert* area.

Notes:

- If you want to mix special and normal characters, you can also type into the *Characters to Insert* area.
- Press **Up** or **Down** arrows to scroll through the available characters.

3. To delete characters from the area, press **Backspace** or highlight the characters and press **Delete**.
4. When you are done choosing special character(s), touch the **OK** button . The special characters are inserted in the active text object at the current cursor position.

Working with Barcodes

Barcodes are generated following industry standard symbology. A typical barcode is composed of vertical lines (bars) and spaces of varying thickness, depending on the text entered. It can also include human readable text. Human readable text is the data entered from which the barcode is generated. Because you cannot read bars and spaces, you can display the text used to generate the barcode as well.

Barcode elements support vertical resizing (height) only. The width of the barcode is based on data and symbology and cannot be changed. However, some barcode widths, depending on the symbology used, can be altered by changing the ratio and density of the barcode.

Barcode data can be displayed in the same line as other data (text or symbols). It is not necessary to have a separate area for the barcode. Barcode data on the same line as text is placed next to the text rather than overwriting the text.

Like other object elements on the printer, barcode elements can be positioned, aligned, and rotated.

This section covers making changes to a barcode that is already on the label. For information on adding a barcode, see “Barcode Objects” on page 41.

Changing a Barcode

To change a barcode:

1. In the *Editor*, select a barcode object.
2. Touch the **Change Barcode** button.

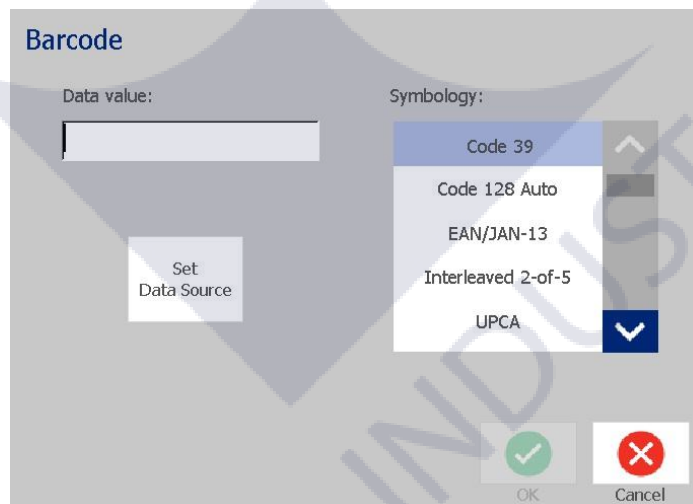

3. In the *Barcode* dialog box, change the desired options:
 - **Data value**
 - **Symbology**
 - **Set Data Source (optional)**. See “Converting Text or Barcode to Variable Data” on page 64 for details.
4. When done, touch the **OK** button. ✓



Changing Barcode Options

Barcode options include setting a different ratio and density and increasing or decreasing the barcode size.

Barcode Size, Ratio, and Density

To change the barcode size, ratio, or density:

1. In the *Editor*, select a barcode object.
2. In the *Control Panel*, edit the desired settings.

- **Size:** Touch  to increase or  to decrease the barcode vertically. Changes are immediately reflected in the *Editor*.
- **Ratio:** Ratio is the thickness between a narrow bar and a wide bar (overall width of the barcode). Does not apply to all symbologies. Choose from one of the three options . Changes are immediately reflected in the *Editor*.





- **Density:** Density controls the width of the barcode lines and spaces. Typically, the thinner the bar and spaces, the higher the bar code density and the less space it takes on a label. Touch the **Density** button, and then, in the *Density* dialog box, choose a density for your barcode. Touch the **OK** button. The changes are immediately reflected in the *Editor*.

Human-Readable Text Options



Barcode text options let you choose whether to show any human-readable text on your barcode and where it should be positioned (above or below the barcode).

You can also decide whether you want the text to include a check character or a start/stop character.

To add human-readable text:

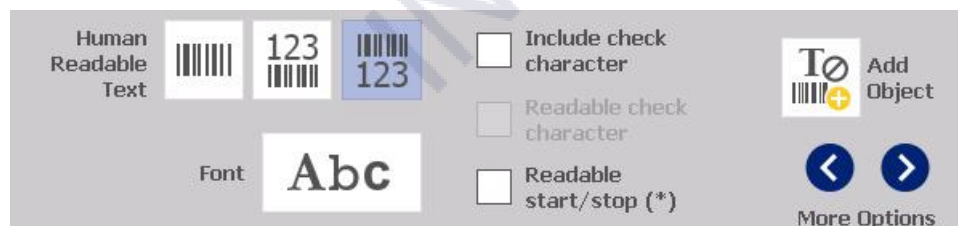
1. In the *Editor*, select a barcode object.
2. Touch the **More Options** button   to go to the *Human Readable Text* control panel.



3. Choose the **Human-Readable Text** option you want: *none*, *above barcode* or *below barcode*.
4. To choose a font and/or size for your human-readable text, touch the **Font** button. 
5. In the *Font* dialog box, choose a font, size and/or style for the human-readable text that will be included on your barcode.
6. When done, touch the **OK** button . The barcode reflects the changes.
7. Select the check character options you want for your barcode. The changes are immediately reflected in the *Editor*.

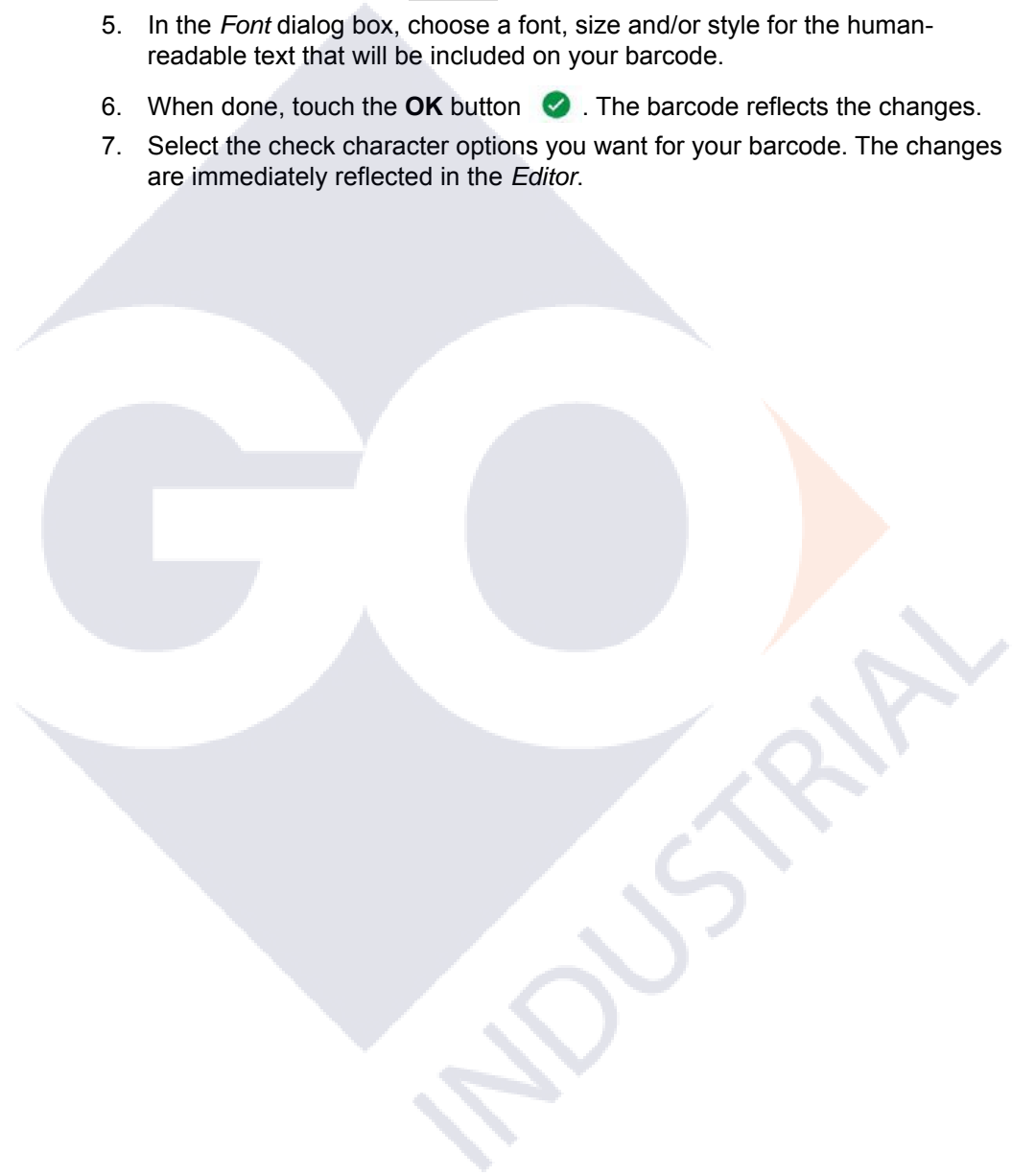

Handling Objects

Editing Objects

To edit an object, touch the object and then edit it using any of the settings and/or attributes available in the Control Panel. If you want to change to a different graphic or barcode, touch the **Change Graphic** or **Change Barcode** button, then change any of the options available in the *Barcode* or *Select Graphic* dialogs.

Moving Objects

Use this procedure to reposition objects on the label. Objects can be positioned either by dragging, using arrow keys on the keyboard, or by setting specific x- and y-coordinates. They can also be positioned by aligning them to one of the edges of the label or centering them either horizontally or vertically on the label.

Note: Objects must be entirely contained within the printable area of the label.

Drag Objects

To drag an object:

1. In the *Editor*, select the object you want to move.
2. Drag the object to the new location.

Notes:

- If you drag an object off the edge of the displayed part of the label (but still within the label boundary), the display will automatically scroll so the object stays visible.
 - If you move an object so that some or all of the object is outside the printable area of the label, the object will be repositioned within the label boundary.
-

Use Keyboard Arrow Keys

To move an object using keyboard keys:

1. In the *Editor*, select the object you want to move.
2. On the keyboard, press the up, down, left, or right arrow key [↓←→↑] to move the object in the corresponding direction. If you hold down the shift key while using the arrows, the objects move in larger increments.

Note: The text-editing panel cannot be displayed if you want to move a text object using the arrow keys. If the text-editing panel is displayed, using the arrow keys will move the cursor within the text box. To exit text editing mode, touch **More Options**, then use the arrow keys to move your object.

3. Repeat Step 2 until the object is positioned where you want it.

Set Object Position

Use this procedure if you want to move an item on the label to a specific position by setting the specific x- and y-coordinates.

To move an object using object position coordinates:

1. In the *Editor*, select the object you want to move.
2. In the *Control Panel*, touch the **More Options** button  to navigate to the *Exact Size & Position* option.
3. Touch the **Exact Size & Position** button.
4. Type a value for:
 - **Distance from the top of label** (Y coordinate).
 - **Distance from left edge** (X coordinate).

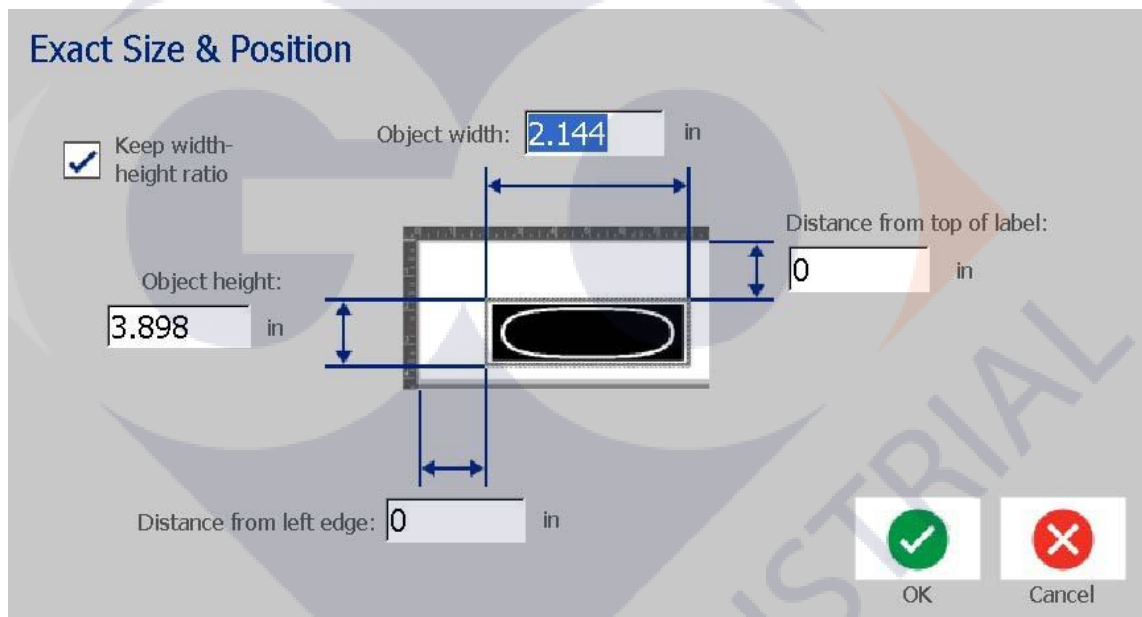

5. When done, touch the **OK** button . The object is displayed at the specified position.

Note: If the values entered result in the object being positioned outside the printable area, the system resizes and repositions the object to fit on the label.

Aligning Objects

To align objects on label:

1. In the *Editor*, select the object you want to align.
2. Touch the **More Options** button   and go to the alignment *Control Panel*:

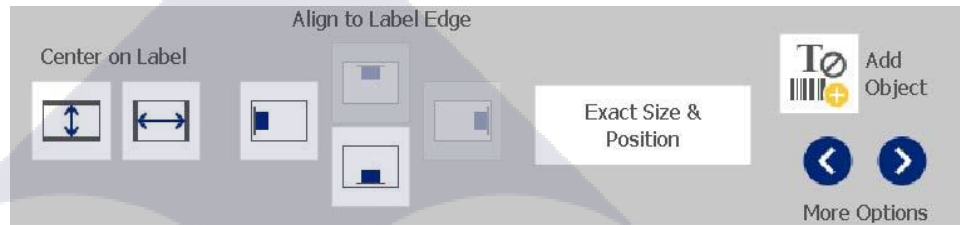



3. Choose the alignment option(s) you want (changes are immediately reflected in the Editor):
 - **Center on Label:** Positions the object in the *vertical* or *horizontal* center of the label.
 - **Align to Label Edge:** Align object to *top*, *bottom*, *left* or *right* of label edge. If the object already reflects an option, or if the option cannot be used for this object, the button is greyed out.

Note: If an option is unavailable, or if the object already reflects the change, the option button(s) are greyed out.

Example:

To move an object to the upper left corner:

- a. Touch  (top).
- b. Touch  (left).



Sizing Objects

Use this procedure to set the object size. Objects can be sized by using the size buttons, dragging objects to size or setting object label length and width.

Note: Sizing an object too large may cause it to overlap or cover other objects in the *Editor*.

Use Size Buttons

To use the size buttons:

1. In the *Editor*, select the object you want to resize.
2. In the *Toolbar*, touch the increase  or decrease  button. Increasing or decreasing the object size with the **Size** buttons results in proportional resizing only.

Note: For barcode objects, resizing occurs only in the direction of the barcode bars (usually the vertical direction, unless the barcode has been rotated).

3. Repeat *Step 2* until the object is the size you want.

Drag Objects to Size

To drag objects to size:

1. In the *Editor*, select the object you want to resize.
2. In the *Tools* panel, touch the **Size** button  to display the sizing handles on the object.

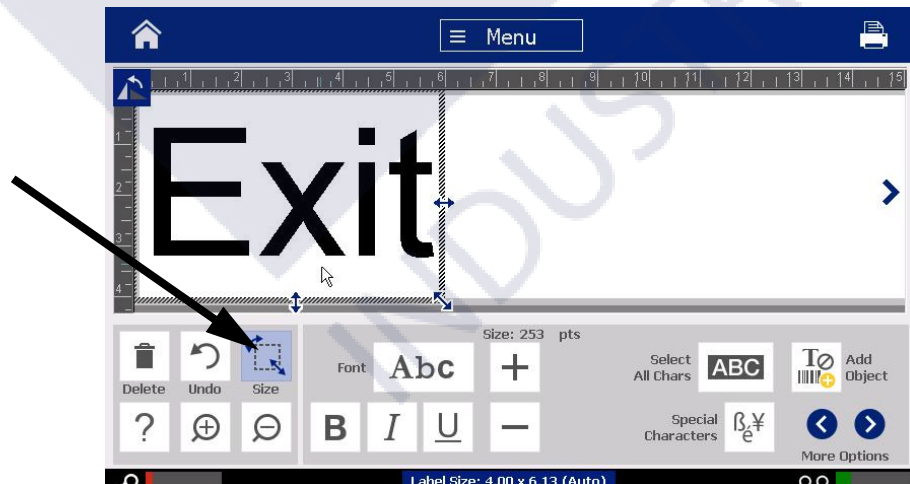

Note: If an object is rotated, the non-proportional sizing handles are hidden. To size non-proportionally, return the object to an unrotated state (0 degrees).

3. Touch a handle and drag on the touch screen to resize the object:
 - **Proportionally:** Drag the corner handle to resize the object proportionally.
 - **Non-Proportionally (Width):** Drag the right-side handle to stretch or shrink the object width in the direction of the handle only.
 - **Non-Proportionally (Height):** Drag the bottom handle to stretch or shrink the object width in the direction of the handle only.
4. To hide the sizing handles, touch the **Size** button  again.

Set Object Size

Use this procedure if you want to size an object by setting the object height and width.

To size an object using object dimensions:

1. In the *Editor*, select the object you want to resize.
2. In the *Control Panel*, touch the **More Options** button  to navigate to the *Exact Size & Position* option.
3. Touch the **Exact Size & Position** button.
4. To maintain the object proportions, select the **Keep width-height ratio** check box.
5. Type a value for:
 - **Object width**
 - **Object height**

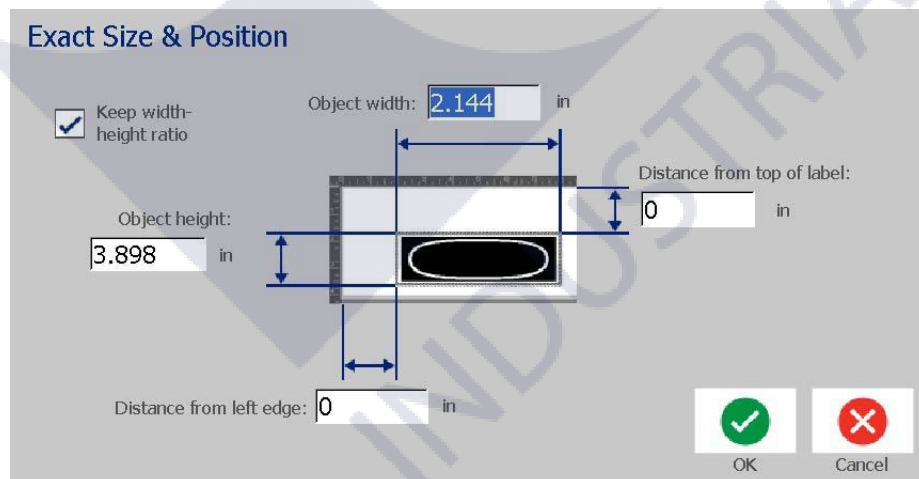

6. When done, touch the **OK** button . The object is displayed at the specified size.

Note: If the values entered result in the object being positioned outside the printable area, the system resizes and repositions the object to fit on the label.

Deleting an Object

To delete an object from a label:

Note: This procedure does not delete the text within an object. To delete text, see *“Delete/Clear Text”* on page 47.



1. In the *Editor*, select the object you want to delete.
2. Touch the **Delete** button  or press **Del** on the keyboard.

Framing an Object

To place (or remove) a frame around an object, the object must be either text or graphic. Barcode objects cannot be framed. When selected, changes are immediately reflected in the *Editor*.

Note: To frame the entire label, see *“Framing a Label”* on page 35.

To frame an object on a label:

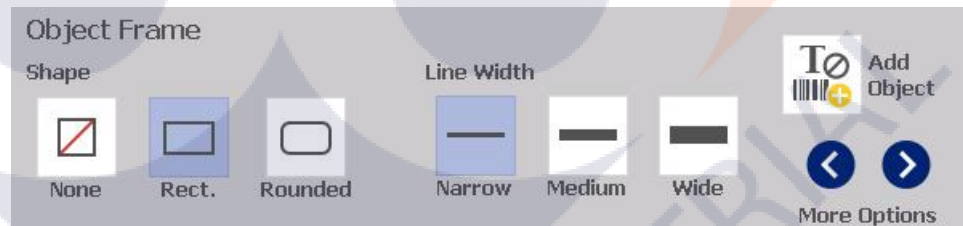

1. With a label defined in the *Editor*, select the object you want to frame.
2. Touch the **More Options** button   to go to the *Object Frame* panel.



3. Select the *Shape* you want around the object (none, rectangle, rounded).
4. Select a *Line Width* for the frame (narrow, medium, wide).

Rotating an Object

To rotate an object:

1. In the *Editor*, touch the object you want to rotate.
2. In the *Tools Panel*, touch the **Size** button  [1] to display the sizing and rotation handles.
3. On the label, touch the **Rotate** button  [2]. The object is rotated 90° counterclockwise.

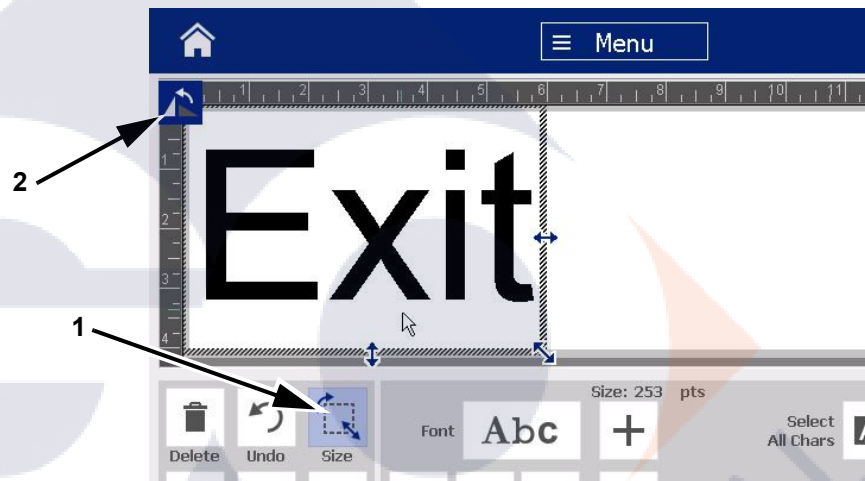

Note: When rotated, the text font will be reduced so that the entire text box fits on the label. The font size will stay reduced even if the object is rotated back to its original position (a full 360°).

4. Repeat *Step 3* to rotate the object further (selecting **Rotate** 4 times returns the object to the original unrotated state).

Converting Text or Barcode to Variable Data

Use these procedures to convert an existing text or barcode object into a serial or date/time object on the label. This applies to both template or freeform objects.

Note: You cannot add serial data to a graphic.

Convert to Serial Data

To convert text or barcode to serial data:

1. In the *Editor*, select the text or barcode object that you want to use for the serial data.
2. **Text:** Touch the **More Options** button  and go to **Set Data Source**.
 - or -

Barcode: Touch the **Change Barcode** button .

3. Touch the **Set Data Source** button.
4. In the *Set Data Source* dialog box, select from the following options to choose the data source and change the format options:
 - **Constant:** Fixed (non-variable) object.
 - **Serial**
 - **Date/Time:** Places a date/time object on your label.
5. Touch the **Serial** button . The *Serial* dialog box displays. See “*Serial Objects*” on page 42 for details.
6. In the *Serial* dialog box, type or select values for setting the serial attributes (the *Sample* area will immediately display an example of the selections):

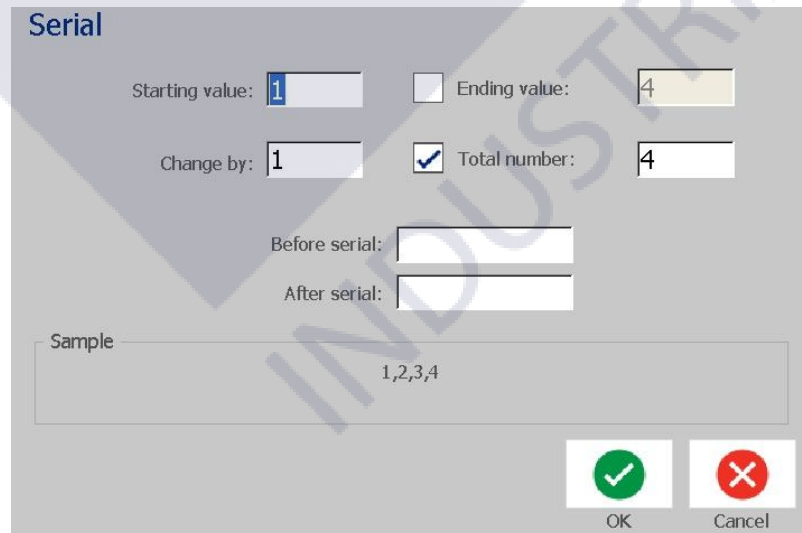

Serial

Starting value: Ending value:

Change by: Total number:

Before serial:

After serial:

Sample:

7. When you touch the **OK** button , The text or barcode object is converted to a serial object on the label.

Convert from Serial Data

Use this procedure if you want to convert a serial object to constant data.

To convert text or barcode to constant data:

1. In the *Editor*, select the serialized text or barcode object that you want converted to constant data.
2. **Text:** Touch the **More Options** button  and go to **Set Data Source**.
 - or -

Barcode: Touch the **Change Barcode** button.



3. Touch the **Set Data Source** button.
4. In the *Set Data Source* dialog box, touch the **Constant** button. The Barcode dialog opens and gives you the option to change the data value.

Note: If you do not change the data value, it will default to the value shown in the *Data value* box.

5. Touch the **OK** button . The object will change to fixed (non-serialized) data.

Convert to Date/Time

To convert a date/time object to constant data:

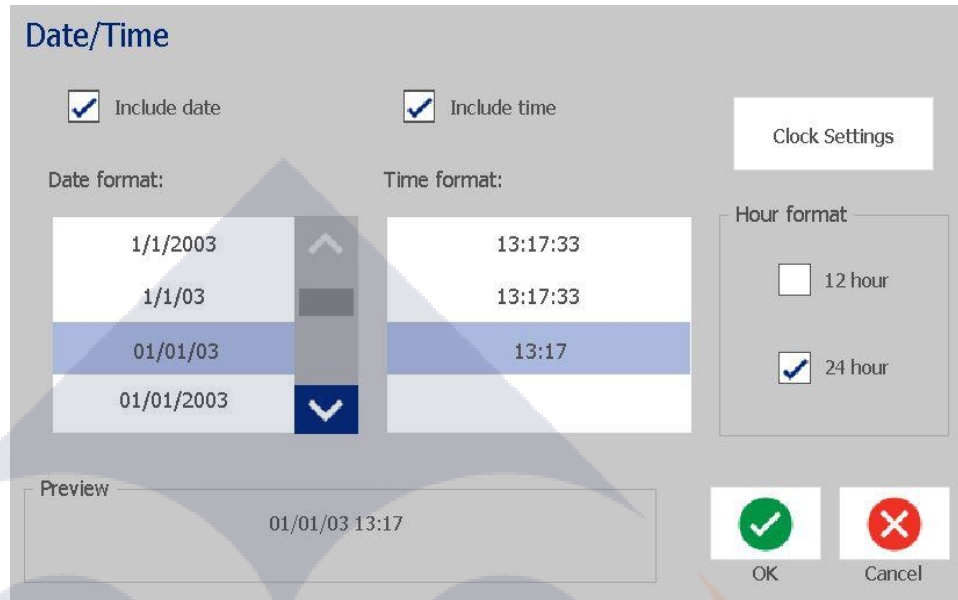

1. Select an object.
 - or -
 Touch the *Editor* to create an object.
2. Touch the **Serial & Date/Time** button . The *Date/Time* dialog box displays. See “*Serial Objects*” on page 42 for instructions.
3. In the *Serial & Date/Time* dialog box, choose either **Date/Time Text** or **Date/Time Barcode**.
4. In the *Date/Time* dialog box, choose the settings you want for the object.



- When done, touch the **OK** button. ✓

Convert from Date/Time

To convert a date/time object to constant data:



- Select the date or time object.
- Touch the **More Options** button   to go to the *Set Data Source* option.
- Touch the **Set Data Source** button.
- Touch the **Constant** button. The date/time is converted to editable data.

5 Printing Your Labels



Previewing Labels

Preview your labels before printing to make sure they will print as expected.

To preview a label:

1. With a defined label in the *Editor*, touch the **Print** button. 
2. From the *Print* dialog box, touch the **Preview** button . The entire label is displayed for your review.



3. (Serial data only.) If you used serial data, multiple labels are generated. Touch the **Next Label**  or **Previous Label**  button to view the labels generated from the serial object.

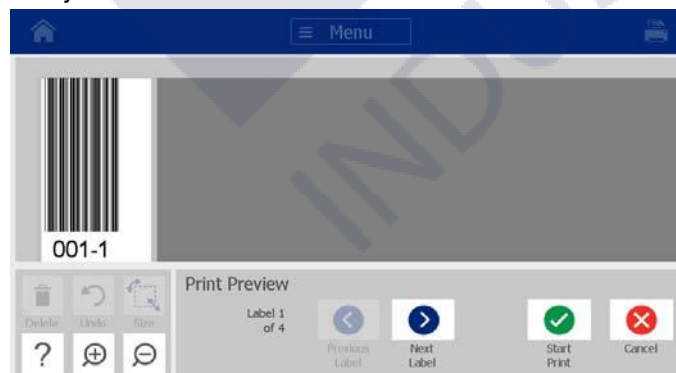

4. Touch the **Start Print**  or **Cancel** button .

Printing Labels



As you print your labels, keep the following in mind:

- The printer cuts between labels or at the end of the job, according to the selected cut settings.
- If there is no media or ribbon installed, printing does not start and you will be prompted to install media or ribbon.
- If you open the ribbon cover during the print operation, printing stops and a message displays prompting you to close the cover. The print job is canceled. To print the labels, you must restart the print job.

Printing Labels

Use this procedure to print labels created on the printer.



To print labels:

1. With a defined label in the *Editor*, touch the **Print** button . The *Print* dialog box displays with default copies set to 1.
2. From the *Print* dialog box, select the print options:
 - **Copies:** (Visible only for a label that does not contain serial data.)
 - **Labels to print:** (Visible only for labels with serial data.) Choose whether to print all labels, or select a range of labels to print. One set of labels is printed. If the label includes more than one serial object, the option to “print all labels” results in one complete set of the labels generated from the serial object that prints the most labels; the shorter series will repeat until the longer series is completed.
 - **Mirror:** Print labels suitable for reading in a mirror or through the back of the label. The Mirror setting is **not** retained for the next print job. The Mirror setting must be reselected each time you want to print mirror-image labels.
 - **Preview**
 - **Print energy** (accessed from the *Advanced Settings* button)
 - **Adjust Offset** (accessed from the *Advanced Settings* button)
3. Touch the **Start Print** button  to start printing the label.

Canceling a Print Job

Multiple print jobs can reside in the print queue. Only the currently printing job can be cancelled.

To cancel a print job:

1. On the *Home* screen, touch the print button  to display the *Print* dialog box if it is not already displayed.
2. In the *Print* dialog box, touch the **Cancel Current Print Job** button . The printer immediately stops printing and displays a *Cancel Job* confirmation message.
3. Touch **Yes** to cancel the job. The printer cuts the media.

Note: Once canceling is confirmed, the print job cannot be resumed.

Resuming an Interrupted Print Job

Use this procedure to resume a print job that was interrupted.

To resume an interrupted print job:

1. When the job interruption message displays, correct the condition that caused the interruption (e.g., replace the media or ribbon).
2. Select the option to continue:
 - **Resume Current** (reprints the current label, then continues printing)
 - **Resume Next** (prints the next label, then continues printing)
 - **Cancel** the print job.

Feeding and Cutting Label Stock

If you install media that has a roughly cut front edge, it is best to feed and cut the media. Also, feed and cut media if you have a partially printed job that you need to remove from within the printer.

To feed and/or cut label stock:

1. With the printer power on, press **Feed**  repeatedly until the length of media you want exits the printer.

Note: For die-cut media, the media advances to the cut position which is the next die-cut label. For continuous media, the media advances two inches each time you press the Feed button.

2. If desired, press **Cut** . The printer will cut off the media.

Adjusting Print Energy

If your printing is spotty, you may want to increase the darkness of the print. However, if your ribbon is sticking or tearing during printing, the heat energy may be too high and should be reduced.

⚠ CAUTION!

Constantly printing at high energy levels may cause printer jams or other printing errors and may reduce the overall life of your printhead.

To adjust the print energy:

1. With a defined label in the *Editor*, touch the **Print** button. 
2. In the *Print* dialog, touch the **Advanced Settings** button.

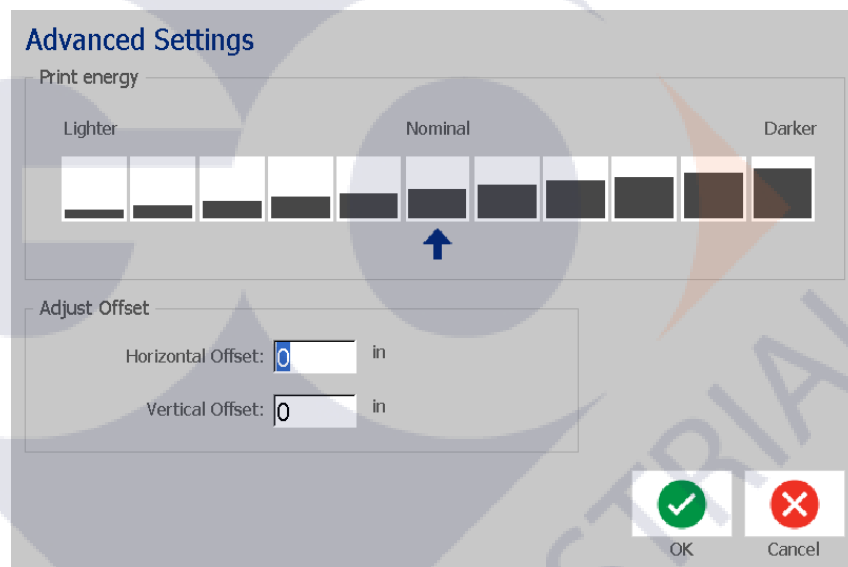

3. In the *Print Energy* area, select the appropriate box to make the print darker or lighter.

Note: By default, the print energy is at the nominal setting for the best overall performance.

4. Touch the **OK** button . The print energy level is changed and the *Print* dialog box is displayed.

- Choose your print options and touch the **Start Print** button . The system uses the new setting for printing the label(s) in this print job.

Note: The selected print energy setting will stay in effect for all subsequent print jobs with the currently installed media. When new media is installed, the print energy level is reset to the default setting. The print energy level is also reset by rebooting the system.

Adjusting Print Offset

Print Offset is a value that will move the image from its “nominal” position slightly in one direction or another on the label. Adjust Offset is typically used to do a fine adjustment of the printed image on a die-cut label, or to move the image slightly closer or further from the edge of a continuous supply.

To adjust the print offset:

- With a defined label in the *Editor*, touch the **Print** button. 
- In the *Print* dialog, touch the **Advanced Settings** button.

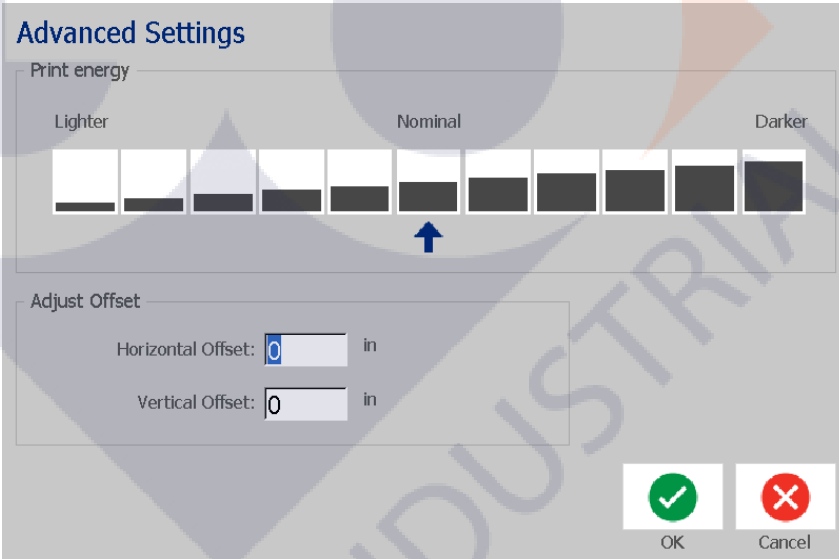

- In the *Adjust Offset* area, enter a value in the horizontal and/or vertical offset boxes:
 - Horizontal Offset:** shifts the image (printed portion of the label) to the right or left.
 - Vertical Offset:** shifts the image (printed portion of the label) up or down.

Printing from a PC

Use this procedure to print labels that you created on a PC. See *“Compatible Applications”* on page 2 for more details.

Note: To use this procedure, the printer must be physically connected to PC, the appropriate drivers (i.e., printer driver, USB driver) must be installed on the PC (see *“Using Your Printer with a PC”* on page 15) and the BradyPrinter S3100 printer must be powered on.

To print from a PC:

1. From the label creation application at the PC, start the print job. The job is sent to the print queue on the printer. To cancel a job see *“Canceling a Print Job”* on page 69.



6 Working with Label Files

Save a Label File

Use this procedure to save a label file.

1. With a label created in the *Editor*, touch the **Menu** button.
2. Touch the **Save File** button . The *Save File* dialog box displays.

Note: If the label was previously saved, the system defaults to that location and file name. If the storage location is no longer available (e.g., the external storage location has been removed), the system defaults to the internal memory location.

3. Choose a **Label Location**:
 - **Internal Memory** (file is saved on the printer).
 - **External USB** (file is saved on a USB flash drive). If the location is full, no files can be saved until one or more files in that location are deleted.

Note: The system will support only one USB flash drive at a time.

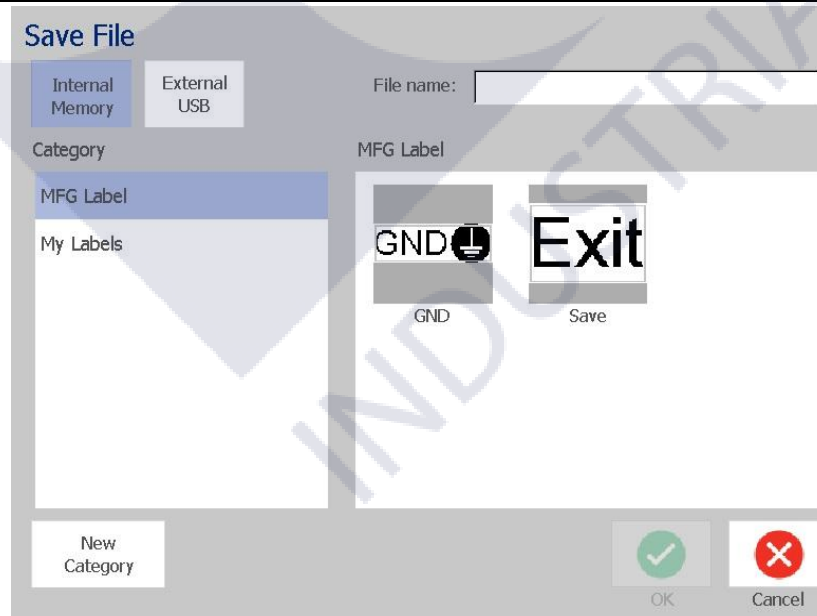

4. Choose a **Category** or touch the **New Category** button and type a category name.

5. Choose a **Filename**: Type a name for the label file, or confirm the existing label file name, if the file has been previously saved in this location. The system will not let you type illegal characters.

Note: If filename already exists, the system will ask if you want to replace the existing file.

6. Touch the **OK** button  to save the label file. The label remains displayed in the *Editor*.

Open a Label File

Use this procedure to retrieve a label file that has been saved in internal or external storage.

1. Touch the **Menu** button.
2. Touch the **Open File** button . If a label file with unsaved changes is currently in the *Editor*, you will be prompted to save the current label. Touch **No** if you do not want to save the label.
3. In the *Open Label File* dialog box, select the **Location** and **Category** where the file is stored. The system will display all of the label files available at that location.
4. Select the label file you want to open. The label will immediately open in the *Editor*.

Note: If the selected label does not fit on the currently installed media, you will be prompted to have the system make the data fit, or cancel the operation. If you choose to make the data fit, objects will be moved and/or resized to fit on the label.

Delete a Label File

To delete a label file:

1. Touch the **Menu** button.
2. In the menu list, touch the **Delete File** button .
3. In the *Delete Label File* dialog box, choose the location where the file is located:
 - **Internal Memory** (label files saved on the printer)
 - **External USB** (label files saved on a USB flash drive)
4. Choose the **Category** where the label is saved. The system will display the label files available in the selected location.

5. Touch the label file you want deleted.
6. At the prompt to confirm file deletion, touch **Yes**. The file is permanently deleted.

- or -

Touch **No** if you want to return to the previous screen without deleting the file.

Note: If you delete all labels in a category, the system will automatically delete the category (except My Labels).



7 Using System Tools

Import Graphics

Use this procedure to add your own graphics for use in labels that will be created on the printer. Graphics that will be imported must be in the supported format(s) and imported from a USB flash drive. Supported graphics file formats are Windows metafile (*.wmf) and Bitmap (*.bmp).

Note: This is a monochrome printer. Imported graphics should be black and white.

Windows metafile (*.wmf) formats are vector images that maintain their clarity and crispness when they are resized. Bitmap files (*.bmp) are composed of pixels which may appear fuzzy and become distorted when they are resized. Be sure to choose the correct format for the graphic you are using.

To import a graphic:



1. Copy the graphics you want to import into the root directory of the USB flash drive you will be using.
2. Connect the USB flash drive that contains the graphic(s) to any available USB port on the printer.

Note: The system will only support one USB flash drive at a time.

3. Touch the **Menu** button.

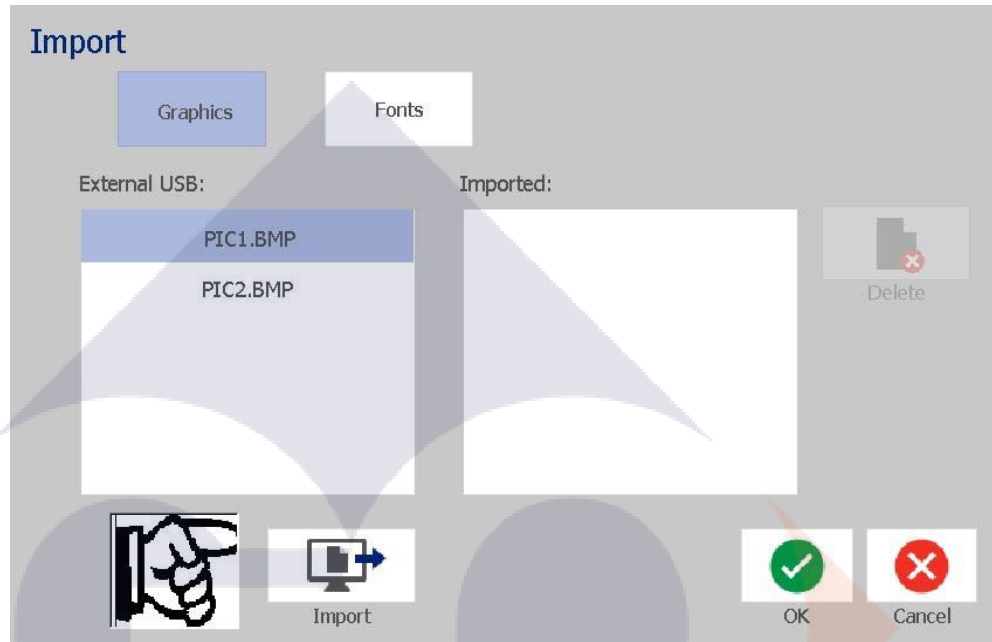
4. Touch the **Import** button . The *Import* dialog box displays.



5. In the *Import* dialog box, touch the **Graphics** button.
6. In the *Available:* list, select the graphic you want to import. A preview of the selected graphic shows at the bottom of the dialog box.
7. Touch the **Import** button . The graphic will be imported and the name will display in the *Imported* list.
8. Repeat Steps 5-7 until all of your graphics have been selected.
9. Touch the **OK** button . The graphics are placed in the *Imported Graphics* category for using on labels. For more information on adding graphics to a label, see “*Graphic Objects*” on page 39.

Note: If there is not enough space available to store the imported graphic(s), you will have to clear some space by deleting saved files (“*Delete a Label File*” on page 74) or deleting previously imported files (“*Delete Imported Graphics*” on page 78) before you can import any new graphics. There is approximately 56MB of storage space available.



Delete Imported Graphics

Use this procedure to delete your own imported graphics that you no longer need.

To delete a graphic:

1. Touch the **Menu** button.
2. Touch the **Import** button . The *Import* dialog box displays.



3. In the *Import* dialog box, touch the **Graphics** button.
4. In the *Imported:* list, select the graphic you want to delete.
5. Touch the **Delete** button. .
6. Touch **Yes** to confirm the deletion. The graphic will be deleted from the *Installed* list.
7. Repeat Steps 3-6 to delete additional graphics.
8. Touch the **OK** button  to exit the dialog.

Import Fonts

Use this procedure to add your own fonts for use in labels created on the printer. Only True-Type fonts can be imported.



To import a font:

1. Copy the fonts you want to import into the root directory of the USB flash drive you will be using.
2. Connect the USB flash drive to any available USB port on the printer.

Note: The system will only support one USB flash drive at a time.

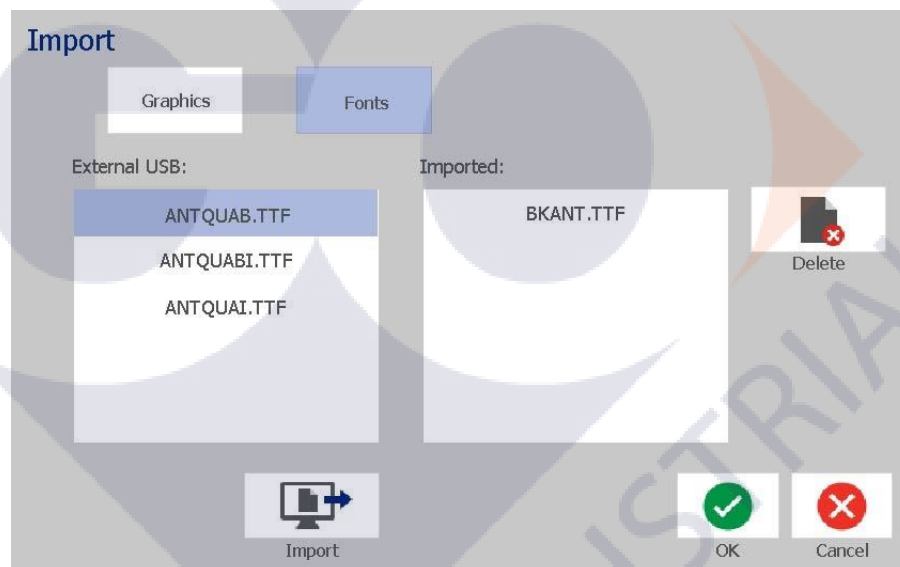
3. Touch the **Menu** button.
4. In the menu options list, touch the **Import** button . The *Import* dialog box displays.



5. In the *Import* dialog box, touch the **Fonts** button.
6. In the *External USB* list, select the font you want to import.
7. Touch the **Import** button . The font will be imported and the name will display in the *Imported* list.
8. Repeat Steps 5-7 until all of your fonts have been imported.
9. Touch the **OK** button. 

Note: If there is not enough space available to store the imported font(s), you will have to clear some space on the system before you can import any new fonts. You can clear space by deleting saved files. There is approximately 56MB of storage space available.

Installing Firmware Upgrades

To upgrade firmware:



CAUTION!

Do not interrupt printer power during an upgrade.

1. On a computer, go to www.bradyid.com.
2. Point to **Technical Support** and then, under the *Downloads* heading, click **Firmware**.
3. Find the most recent BradyPrinter S3100 firmware upgrade in the list and click it. You can sort the list alphabetically to make it easier to find the printer model.
4. Click **Begin Download**.
5. Save the downloaded file to a USB flash drive.
6. Connect the USB flash drive to any available USB port on the printer. The printer recognizes the upgrade file and displays a message on the touch screen.
7. Follow the instructions on the touch screen. When the upgrade is complete, the printer restarts.

8 Maintenance

Removing Power and Media from Printer

Before performing any maintenance procedure that involves opening the enclosure cover, you should remove the power and media from the printer.

To remove printer power and media:

1. Remove the power plug [1] from the printer.



2. Open the enclosure cover (opens from left).



3. Release the latch on the ribbon cover [2] and swing open.
4. Release the ribbon cartridge latch [3] and lift the ribbon cartridge up and out.

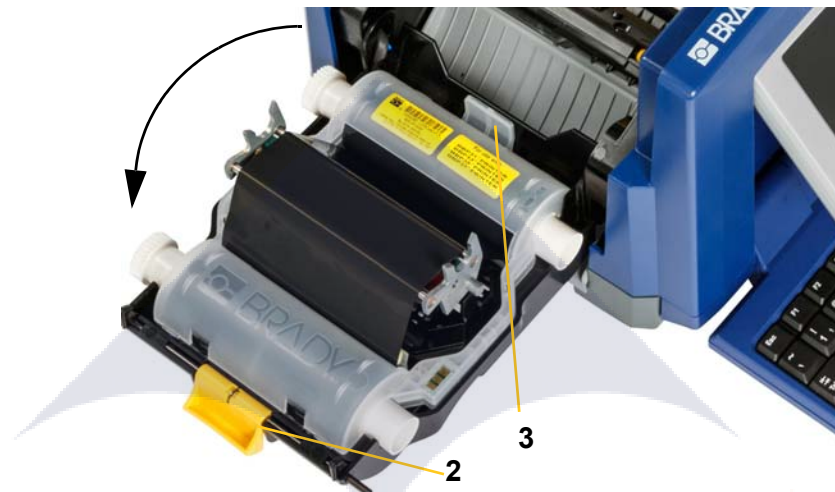

5. Move yellow media wiper [4] to far right (when facing display).
6. Move yellow media guides [5] to full-open.
7. Remove media cartridge from the slots of media holder [6].



Cleaning the Printer

Cleaning Residue from Printer and Keyboard

Whenever performing any maintenance on the printer, you should also clean any residue caused by the media.

Materials Required :

- Compressed Air Bottle, purchased locally (e.g., HOSA AIR-464 Gear Duster)
- Lint-free Cloth
- Isopropyl Alcohol
- Safety Glasses

To clean residue from the printer:



CAUTION!

Always wear safety glasses when using compressed air.

1. Remove power and media from the printer (see “Removing Power and Media from Printer” on page 81).
2. With safety glasses on, spray compressed air on any parts of the printer and keyboard that have built-up residue.

Note: If compressed air is not available, use a lint-free cloth lightly moistened with isopropyl alcohol and wipe off residue.

3. If necessary, use a moistened, lint-free cloth to clean the keyboard keys.
4. Replace the ribbon and tape.
5. Close all covers and plug in the power cord.

Cleaning the Touch Screen

Materials Required

- Lint-free Cloth, non-abrasive
- Isopropyl Alcohol
- or -
- Pre-moistened Cloth (appropriate for cleaning PC screens)

To clean the touch screen:

Note: Normal cleaners with ammonia, soaps, or any acids can damage the screen. Use only a lint-free cloth dampened with isopropyl alcohol.

1. Lightly moisten a lint-free cloth with isopropyl alcohol, or use a pre-moistened cloth suitable for cleaning a PC screen.
2. Gently rub the damp cloth across the screen until all of the residue is removed.

Cleaning the Cutter Blade

Note: When cleaning the cutter, you should also clean the media and cutter sensors.

Materials Required

- BradyPrinter S3100 Cleaning Kit (Cat # B31-CCT)
- Isopropyl Alcohol
- Cutter Cleaning Tool (included in cleaning kit)

To clean the cutter:

1. Remove power and media from the printer (see “Removing Power and Media from Printer” on page 81).
2. Squeeze the two yellow cutter tabs [7] to release the cutter. The cutter mechanism and exit chute [8] will slide down behind the ribbon cover.

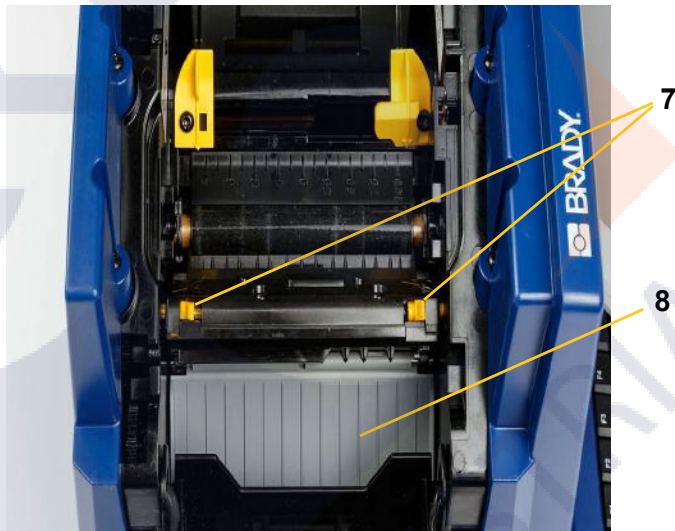

3. Fill the plastic bottle from the cleaning kit with isopropyl alcohol.

4. Clean metal cutting blade [9]:
 - a. If the cutting blade shows significant residue, use the cutter cleaning tool in the cleaning kit to gently scrape the residue off the cutting blade.
 - b. Moisten one of the foam swabs from the cleaning kit with the alcohol. Do not allow the alcohol to drip from the swab.
 - c. Clean cutting blade with moistened swab until all residue is removed.
 - d. Clean beneath the edges of the blade housing with moistened swab. To avoid forcing residue deeper into the machine, use motions from the outer edge of the blade toward the center.
 - e. Continue cleaning until no residue is visible and clean swabs do not become discolored.



5. Close the cutting blade by pushing up on the exit chute until the cutter tabs snap into place.

Note: You may need to hold ribbon cover up slightly to access the exit chute.

6. Replace the ribbon and tape.
7. Close all covers and plug in the power cord.

Cleaning the Sensors

The media and cutter sensors are located inside the printer and may be covered with dust that results from cutting the media. The media sensor is located under the yellow media guide. The cutter sensor is located above the cutting blade and is visible only when the cutter is released.

Materials Required

- BradyPrinter S3100 Cleaning Kit (Cat # B31-CCT)
- Isopropyl Alcohol

To clean the sensors:

1. If necessary, remove power and media from the printer (see “Removing Power and Media from Printer” on page 81).
2. If not already released, squeeze the two yellow cutter tabs to release the cutter.
3. With a pre-moistened foam swab, gently wipe the surface of the media sensor [10] and cutter sensor [11] at the locations shown in the figure. Do not allow the alcohol to drip from the swab.

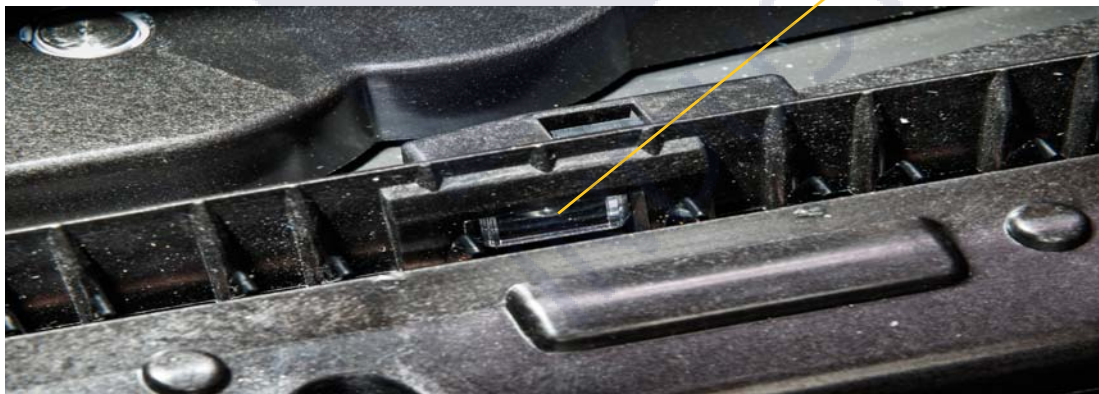
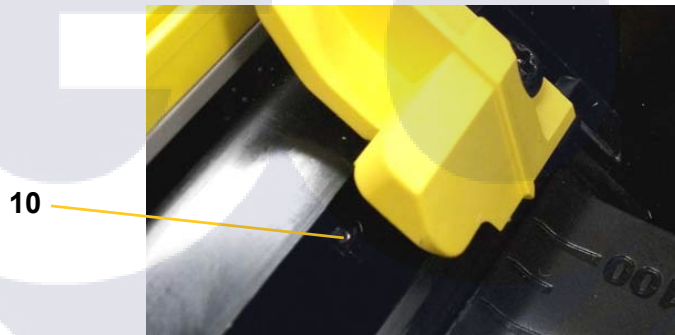

Cleaning the Cutter Blade Exit Area

This procedure cleans the cutter blade exit area and the exit chute.

Note: You should clean the exit area after cleaning the cutter blade and sensors. The cleaning swab may be damaged when cleaning the exit area.

Materials Required

- BradyPrinter S3100 Cleaning Kit (Cat # B31-CCT)
- Isopropyl Alcohol

To clean the exit chute:

1. If necessary, remove power and media from the printer (see “*Removing Power and Media from Printer*” on page 81).
2. Close the ribbon cover. It does not need to snap into place.
3. Using swabs from the cleaning kit moistened with alcohol, clean the exit chute entrance [12] and exit chute ramp [13].

Note: To reach all areas of the exit chute, you can close the enclosure cover and tilt the printer up on its side.

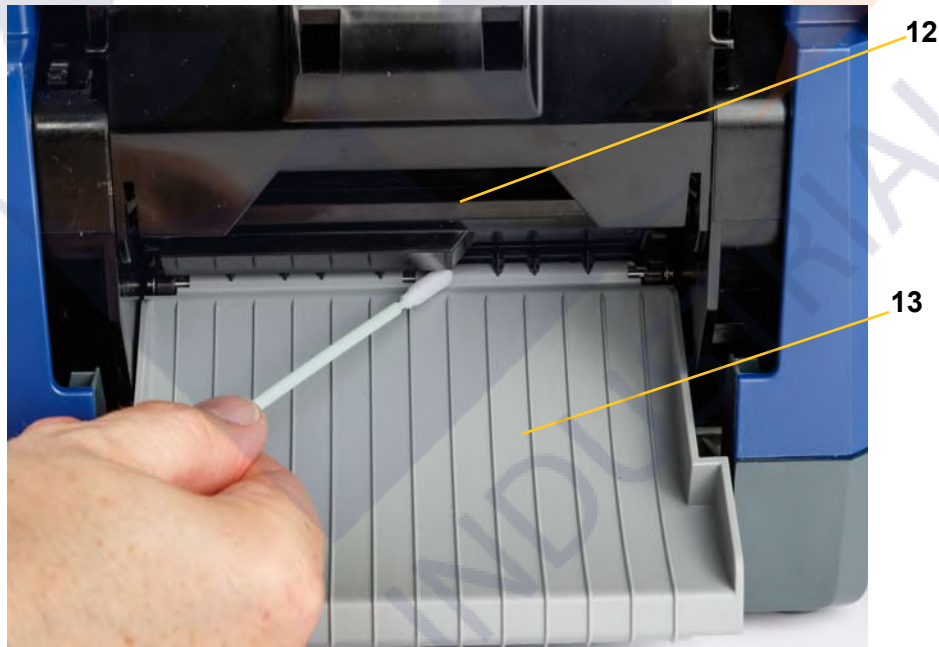

4. Replace the ribbon and tape.
5. Close all covers, plug in the power cord, and turn on the power switch.

Dust Cleaning

Dust generated by media cuts can accumulate in the unit. If a significant amount of dust is built up, clean the unit using this procedure.

Materials Required

- BradyPrinter S3100 Cleaning Kit (Cat # B31-CCT)
- Isopropyl Alcohol
- Compressed Air Bottle, purchased locally (e.g., HOSA AIR-464 Gear Duster)

To clean dust from the unit:



CAUTION!

Always wear safety glasses when using compressed air.

1. Remove power and media from the printer (see “*Removing Power and Media from Printer*” on page 81).
2. Using compressed air, spray all visible areas inside the printer to remove accumulated dust.
3. Using a cloth moistened with isopropyl alcohol, wipe any remaining dust from inside the printer.
4. Wipe exterior cover and frame of printer for dirt and residue.

Cleaning the Printhead

Materials Required

- BradyPrinter S3100 Cleaning Kit (Cat # B31-CCT)
- Isopropyl Alcohol

To clean the printhead:

1. Remove power and media from the printer (see “*Removing Power and Media from Printer*” on page 81).
2. Fill the plastic bottle from the cleaning kit with isopropyl alcohol.

Note: Do not rub the swab over the bronze-colored area of the printhead.

3. Moisten one of the foam swabs from the cleaning kit with the alcohol and gently rub across the green and black area of the printhead [14].



CAUTION!

Use only the materials supplied in the cleaning kit. Using other materials may permanently damage the printhead.

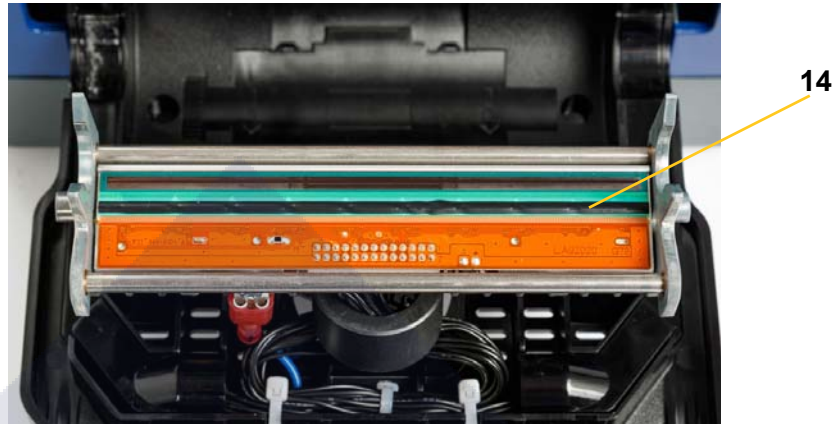

4. Replace the ribbon and tape.
5. Close all covers and plug in the power cord.

Replacing the Media Wiper

Materials Required

- B31-WIPER

To replace the media wiper:

1. Remove power and media from the printer (see “Removing Power and Media from Printer” on page 81).
2. Lift and hold the wiper arm while grasping the tab of the wiper insert [15].
3. Pull the tab slightly forward and then slide the wiper insert out of the wiper arm.
4. To replace the wiper, insert the lip of the wiper insert into the slot [16] of the wiper arm and slide in until the tab snaps into place.



5. Replace the ribbon and tape.
6. Close all covers and plug in the power cord.

Clearing Jams

Clearing a Printer Jam

To clear jams from the printer:

1. Remove all damaged ribbon and/or media from the printer.
2. Check that there is no damage to the print head, cutter blades, sensors, etc.
3. Check whether any cleaning is needed. If cleaning is required, see “*Cleaning the Printer*” on page 83 for details.
4. Reload ribbon and media and clear all error messages.

Clearing a Cutter Jam

To clear a jam from the cutter:

1. Cut the media as shown below.



2. Squeeze the tabs to release and tilt the cutter module.

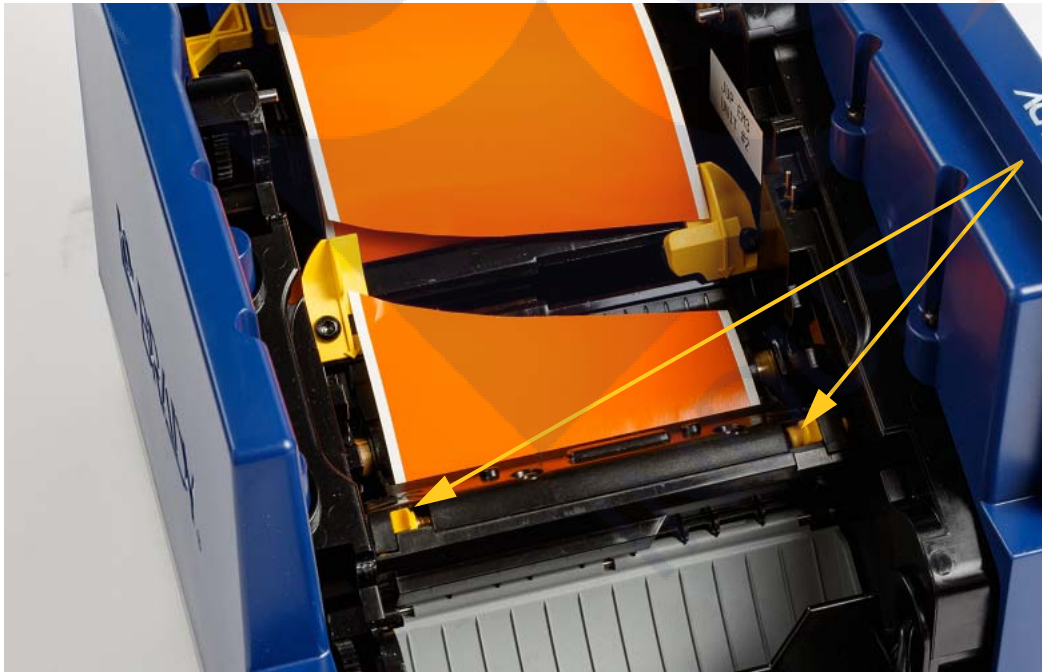



3. Rotate the cutter gear counter-clockwise to lower the blade.



4. Remove the media.
5. Rotate the gear clock-wise to raise the blade.
6. Push the cutter mechanism back into place so that the pins snap into place.

9 Troubleshooting

Use the following table to troubleshoot problems. In situations where the printer displays an error message, follow the instructions on the touch screen.

Problem	Cause	Corrective Action
Keyboard works intermittently or not at all.	One or more keys is stuck in depressed state.	Identify any keys stuck in down position. Repress key to unstick. Clean the keyboard (see <i>“Cleaning Residue from Printer and Keyboard”</i> on page 83).
Printer does not power up when turned on.	Power cord has been pulled out of printer or wall socket.	Check power cord.
Screen freezes	User Interface error	<ol style="list-style-type: none"> 1. Press Sleep/Wake  . 2. After printer goes to sleep, press Sleep/Wake  again. If that doesn't work: <ol style="list-style-type: none"> 1. Turn off the power switch on the side of the printer. 2. Wait five seconds and then turn the power switch on.
Printer will not feed labels.	<ul style="list-style-type: none"> • The leading edge of the label roll is not inserted correctly. • The leading edge of the label roll is uneven or torn (not a straight edge). 	<ul style="list-style-type: none"> • Install the media correctly • Cut a straight leading edge on the label roll.
Faint print on labels.	Ribbon not advancing correctly.	<ul style="list-style-type: none"> • Tension the ribbon by rotating the rewind spool (top spool) in a downward direction until all slack is removed. • Try another ribbon cartridge.
	Print energy might be too low.	Adjust the print-energy setting (see <i>“Adjusting Print Energy”</i> on page 70).
No print on the label.	The label or ribbon is not loaded correctly or out of ribbon.	<ul style="list-style-type: none"> • Reinstall the ribbon cartridge. • Load a new ribbon.

Problem	Cause	Corrective Action
Poor print quality.	Ribbon and label media are incompatible, or using an incorrect label material and ribbon combination.	<ul style="list-style-type: none"> • Verify the correct ribbon for the label roll is loaded in the printer. • Change the ribbon or label combination.
	Dust or adhesives accumulated on the printhead.	Clean the printhead (see <i>“Cleaning the Printhead”</i> on page 88).
	Media wiper dirty.	Replace media wiper (see <i>“Replacing the Media Wiper”</i> on page 89).
Void areas or lines appear on printed text.	Ribbon wrinkling.	<ul style="list-style-type: none"> • Tension the ribbon by rotating the rewind spool (top spool) in a downward direction until all slack is removed. • Try another ribbon cartridge.
Cut quality is poor.	Cutter needs cleaning.	Clean the cutter (see <i>“Cleaning the Cutter Blade”</i> on page 84).
Media shifts when printing frames around label causing a slight misalignment of the frame.	Media guides not adjusted correctly, producing slack that allows the tape to shift during printing.	Adjust media guides so they are snug against the media. To make fine adjustments to the frame, see <i>“Adjusting Print Offset”</i> on page 5-8.
Print Queue Full	Other jobs are printing or waiting to print and no additional jobs can fit in the queue.	Wait for a job to complete printing and try again.

A Glossary of Terms

The following are the definitions of terms that are used in this manual.

- **Alignment/Justification** page 4-48: Refers to how text lines are aligned in the text object. Alignment can refer to both horizontal and vertical alignment. Justification is only used in the context of horizontal alignment.
- **Autosize** page 3-31: When setting label length, to automatically set the label length to fit the data included on the label. Applicable for continuous media only. When setting text size, to automatically set the size of the text to the largest possible size that still fits on the label.
- **Barcode** page 4-41: A barcode is a series of black and white bars and white spaces with varying widths. Linear barcodes are based on bars or spaces, bar height, bar position or distance of adjacent bars.
 - **Barcode Check Character:** Identify the barcode symbology and also enable the scanner to read the data in the correct order.
 - **Barcode Start/Stop Characters:** Start/stop characters help to detect errors during the printing process. Available options are:
 - **Include Check Character:** On/off. Includes a check character in the barcode. Does not apply to all symbologies.
 - **Readable Check Character:** Displays the check character on the label if *Include Check Character* is also selected. Does not apply to all symbologies.
 - **Readable Start/stop:** Displays the start/stop character (*) on the label (does not apply to all symbologies).



- **Barcode Ratio:** The thickness ratio between a narrow bar and a wide bar. Usually, the ratio is between 2:1 and 3:1.
- **Barcode Density:** The number of characters that can be captured in a particular space, usually a linear inch. The "X" dimension determines a bar code's density. High-density bar codes have low numbers (e.g., 5 mil) and low-density bar codes have high numbers (e.g., 55 mil). When "X" is small, the area required for each character is less than when "X" is large; thus the bar code can hold more per linear inch and is said to be of higher density. The width of the barcode is influenced by the following 3 variables:
 - **Symbology:** Different symbologies have different widths of bars and spaces.
 - **Ratio of Wide to Narrow Elements:** Basically, changing the width of the narrowest bar in relation to the width of the thickest bar.
 - **Width of Narrowest Bar (x-dimension):** The most common user variable density component, is measured in thousandths of an inch or mils. Very high density barcodes can have a density as low as 3 mils.
- **Category** [pages 28, 39, 73, 74, 74]: Group of related items (symbols, graphics, files).
- **Condense** page 4-49: To compress text characters horizontally but not vertically, distorting the font. Does not change the font size.
- **Default** page 2-20: Predetermined action or setting. The one that will be taken or established if the user makes no changes.
- **Editor** page 1-3: The display area used to create and edit labels.
- **Expand** page 4-49: To widen text characters horizontally but not vertically, distorting the font. Does not change font size.
- **External USB** [pages 73, 74]: Removable device such as a USB flash drive .
- **Feed** page 5-69: Physically advance the media without printing.
- **Font Attribute** page 3-27: General term referring to attributes of text characters. Includes bold, italic, underline, size, superscript, subscript.
- **Font Size** page 4-48: Size of characters, often measured in "points" although sometimes in inches or mm.
- **Frame** page 4-62: A printed outline around the label or portion of the label.
- **Function:** An action or operation. Often used on a keypad key to access secondary operations from other keys.
- **Graphic:** An image or visual representation of an object. Any non-photo image or (non-text) symbol.
- **Horizontal Offset** page 5-71: Shifts the image (printed portion of the label) to the right or left.
- **Internal Memory** page 6-73: Memory built into the device used for permanent storage of files, graphics, fonts, templates, etc.
- **Key:** Physical component, typically on keyboard. Used for data entry and navigation.

- **Keystrokes** page 4-50: A combination of keys that when typed together result in a special or accented character. Keystroke types are:
 - **Alt Gr** (Alternative Graphic): A modifier key used to access alternate characters, represented on keys with a third or fourth symbol on the right side. Key accessed also depends on the state of the “Caps Lock” key and the type of toggle it performs.
 - **Alt Gr Lock**: A key that toggles the keyboard between access to Alt Gr and non-Alt Gr mode for specific keys.
 - **Caps Lock**: A key that toggles the keyboard between upper-case and lower-case modes for all alphabetic keys, but has no affect on other keys.
 - **Shift**: A modifier key used to access alternate “upper” characters on keys. Key accessed also depends on the state of the “Caps Lock” key and the type of toggle it performs.
 - **Shift Lock**: A version of caps lock that affects all keys as shift does.
- **Label**: The area on the display where text, graphics and barcodes are located. A discrete “page” or unit of output.
- **Media**: Substrate on which labels are printed. Includes “tape” (continuous) and “label” (die-cut).
- **Menu** page 1-3: A display of options that are provided to a user. There are several types of menus (e.g., pop-up, cascading, pull-down, moving-bar, etc.).
- **Mirror Print** page 5-68: Output that is suitable for reading in a mirror, or through the back of the label.
- **Object** page 4-37: Discrete data, graphic or barcode element on a label that is movable as a unit.
- **Print Energy** page 5-70: Defines how much heat is applied to the printhead when you are printing a label. As you print, heat applied to the printhead elements causes the ink to transfer to the label material as it passes under the printhead. The higher the print energy, the more ink is transferred to the label (i.e., the higher the heat on the heat element). Therefore, if your printing is spotty, you may want to increase the darkness of the print. However, if your ribbon is sticking or tearing during printing, you should reduce the darkness of the print.
- **Print Offset** page 5-71: A value that will move the image from its “nominal” position slightly in one direction or another. Adjust Offset is typically used to do a fine adjustment of the printed image on a die-cut label, or to move the image slightly closer or further from the edge of a continuous supply.
- **Proportional Sizing** page 4-60: Uniform scaling of an object or text. Object maintains its size in both the horizontal and vertical direction.
- **Non-proportional Sizing** page 4-60: Non-uniform scaling of an object or text. Object size is distorted in the direction being sized.

- **Reverse Print** page 4-50: Attribute applied to an object where the foreground and background colors are switched.
- **Rotate** page 4-63: Turning the label data some number of degrees on the label (the printer supports 90, 180, 270 degree rotation only).
- **Screen**: A unit of software content to show on the display (could also be called a page or a window). Not the physical display itself.
- **Sequence/Serialization/Serial** page 4-64: Generating a series of alpha or numeric characters for subsequent labels. Also called variable data.
- **Sizing Handles** page 4-60: Small arrows that appear at the corner (proportional sizing) and sides (non-proportional sizing) of an object.
- **Supply**: Includes ribbon and media or both.
- **Template** page 3-28: Label with predefined content areas or data placeholders.
- **Undo** page 1-4: Restores the last editing operation. For example, if a segment of text was deleted or changed, performing an undo will restore the original text.
- **USB Device** (Universal Serial Bus) [pages 19, 80]: A plug-and-play interface between a computer and other devices. A USB device can be a Type B cable that connects from the PC to a device (e.g., BradyPrinter S3100 printer), or a small, portable storage device (e.g., flash drive).

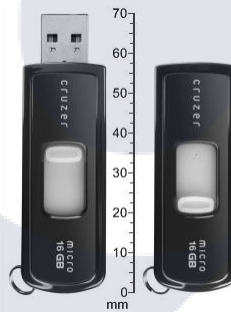

USB Flash Drive

- **Vertical Offset** page 5-71: Shifts the image (printed portion of the label) up or down.
- **Vertical Text** page 4-49: Text characters oriented one above the next, so subsequent characters appear below preceding characters.
- **Wizard** page 2-19: Series of prompts guiding user through specific action(s).

B Character Mapping and IME for Asian Text

Character Mapping

Keyboard configurations vary by region. When used in combination with the **<Shift>** and **<AltGr>** keys, the keyboards support multiple characters. The position in which the character appears on a keycap indicates which combination of keystrokes to use to access the character.

For a complete description of how to use the special characters, see *“Entering Special Characters” on page 53.*

The following are the accent keys that are available depending on which keyboard you have. To access the keys, just press the key and then the character (not simultaneously).

Americas QWERTY

Accent	Characters Affected
`	A, a, E, e, I, i, O, o, U, u
´	A, a, E, e, I, i, O, o, U, u, Y, y
^	A, a, E, e, I, i, O, o, U, u
~	N, n, O, o
¨	A, a, E, e, O, o, U, u
¸	C, c, K, k, G, g, N, n, L, l, R, r, S, s, T, t

European AZERTY

Accent	Characters Affected
`	A, a, E, e, I, i, O, o, U, u
´	A, a, E, e, I, i, O, o, U, u, Y, y, C, c, S, s, N, n
^	A, a, E, e, I, i, O, o, U, u
~	N, n, O, o, A, a
¨	A, a, E, e, O, o, U, u
ˇ	S, s, Z, z, C, c, T, t, N, n, E, e, R, r
˘	A, a, G, g
“	U, u, O, o
°	A, a, U, u
-	A, a, E, e, I, i, U, u
▪	E, e, Z, z, C, c

European QWERTZ

Accent	Characters Affected
`	A, a, E, e, I, i, O, o, U, u
´	A, a, E, e, I, i, O, o, U, u, Y, y, C, c, S, s, Y, y, N, n
^	A, a, E, e, I, i, O, o, U, u
~	N, n, O, o, A, a
¨	A, a, E, e, O, o, U, u
ˇ	S, s, Z, z, C, c, T, t, N, n, E, e, R, r
˘	A, a, G, g
“	U, u, O, o
°	A, a, U, u
ˉ	A, a, E, e, I, i, U, u
ˆ	E, e, Z, z, C, c

European QWERTY

Accent	Characters Affected
`	A, a, E, e, I, i, O, o, U, u
´	A, a, E, e, I, i, O, o, U, u, Y, y, S, s, Z, z, C, c, N, n
^	A, a, E, e, I, i, O, o, U, u
~	N, n, O, o, A, a
¨	A, a, E, e, O, o, U, u
ˇ	S, s, Z, z, C, c, T, t, N, n, E, e, R, r
˘	A, a, G, g
“	U, u, O, o
°	A, a, U, u
ˉ	A, a, E, e, I, i, U, u
ˆ	E, e, Z, z, C, c

European Cyrillic

Accent	Characters Affected
`	A, a, E, e, I, i, O, o, U, u

Using the Input Method Editor (IME)

Printers shipped to certain regions come with an Input Method Editor (IME) for including Asian language characters on labels. The IME converts text to one of the following languages as you type: Chinese Simplified, Chinese Traditional, or Korean. The language is set at the factory depending on where the printer is to be shipped.

Note: The composition window displays the current language of your system. For example, if your printer is setup for Korean, the window displays Korean.

Chinese Simplified

To use IME:

1. Touch the language button **EN** [1] to toggle the language between the current language of your system and Chinese mode.

Note: Touch the *Language* button at any time to toggle between the IME and the standard input, or type **Ctrl-Spacebar** to toggle between languages.

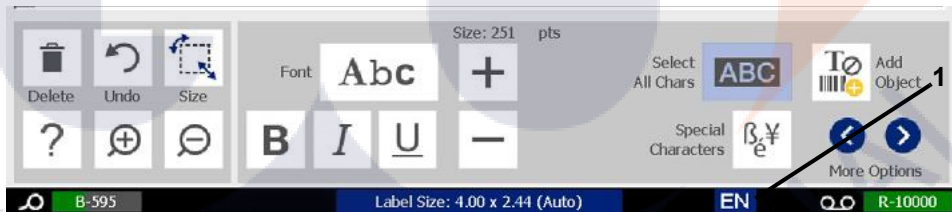

When you start typing, the control and tool panels fade and the Chinese text editor displays.

2. Enter the words or keystrokes that you want converted. A list of candidates is generated and displayed in the Chinese text editor window, with the first candidate highlighted by default [2].

Note: For each letter typed, the IME predicts a set of characters based on the entered text. For frequently selected characters, the printer "learns" the characters and moves them up the list of character options.



3. Touch the candidate you want. The selected words or characters are added at the current cursor position. To use the keyboard:
 - *Change highlighted candidate:* Press keyboard **Up/Down** keys.
 - *Scroll through list:* Press keyboard **Page Up/Page Down** keys.
 - *Select highlighted character:* Press **Spacebar**
 - *Choose a corresponding character:* On keyboard, type 1, 2, 3, etc. to choose the character
4. To close the text editor, press **Esc** or touch anywhere outside the text editor window.
5. Touch the language button  to toggle back to the original language.



Chinese Traditional

To use IME:

1. Press the symbol on the left of the IME control panel [1] to change the language option from English to Chinese Traditional. If nothing happens, press Alt-Shift on the printer keyboard twice to enable the button.
2. In the editor, type the words or keystroke(s) that you want converted. If the keystroke combination forms a character, it will display in the candidate list [2].
3. To choose an option from the candidate list, enter the number of the candidate. The character is immediately added to the text box and the candidate dialog closes.
 - or -
 - Press the ↓ arrow to select the correct candidate, then press **Enter**.
4. Repeat Steps 2 and 3 until all of your text is entered.



Korean

To use IME:



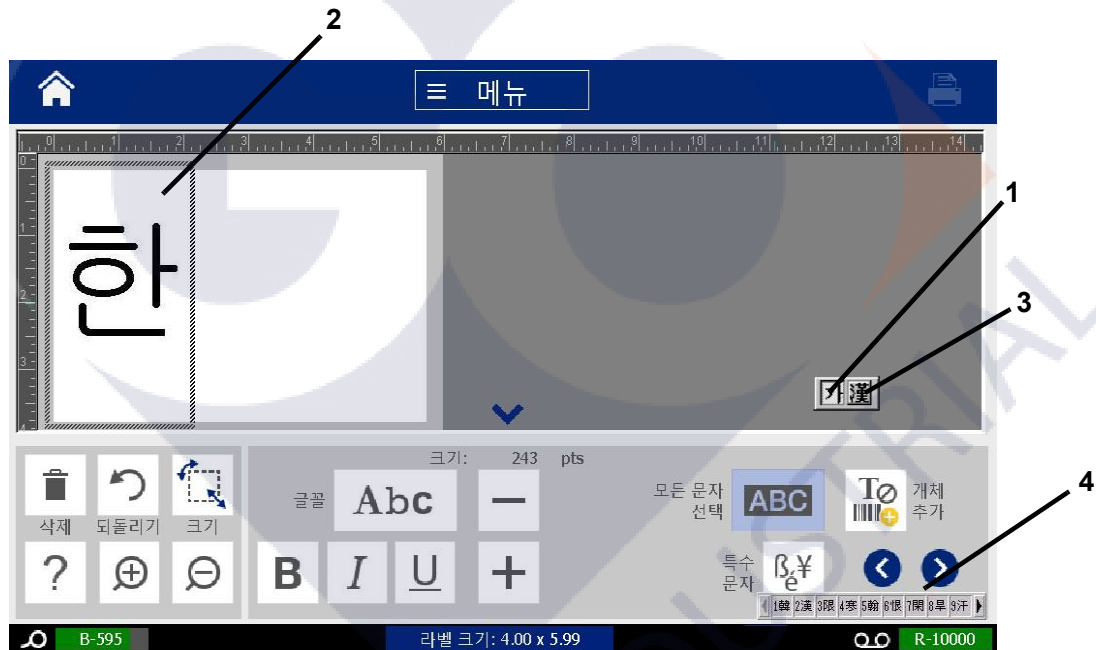





1. Press the symbol on the left of the IME control panel [1] to change the language option to Korean.
2. In the editor, type the words or keystroke(s) that you want converted. If the keystroke combination forms a character, it will display in the text box [2].
3. To choose an option from the candidate list, press the symbol on the right of the IME control panel [3]. The candidate list will open.
4. Touch the candidate you want [4]. The character is immediately added to the text box and the candidate dialog closes.
5. Delete the initial symbol so that only the selected candidate displays.
6. Repeat Steps 2 through 5 until all of your text is entered.



c Specialty Label Types

From the Home page, you can access all of the available label types. You can see all available label types by pressing the **More Label Types** button.

Note: Not all label types will be available with all configurations.

Button	Description
	General Templates: Templates for creating commonly-used label types.
	Custom Label: Lets you create a label without a template.
	Pipe Markers: Standard or roll-form pipe markers and symbol and arrow-tape pipe markers.
	Right To Know (RTK): OSHA (Occupational Safety and Health Administration) chemical warning labels.
	CLP [GHS] Globally Harmonized System: Compliant chemical warning labels. Classification and Labeling intended to minimize physical, health and environmental risks associated with chemicals during transport, storage, use and disposal.
	Arc Flash: Product Safety Signs and Labels for implementing compliant labels appropriate for work practices that are required to safeguard workers from injury while working on or near exposed electrical parts that could become energized.
	PreMade Labels: Specialty labels that let you select from a list of predefined labels.
	WHMIS: (Workplace Hazardous Materials Information system). Canada's national hazard communication program for hazardous workplace chemicals of controlled products and hazardous materials.
	HSID: (Hazardous Substances Identification). Compliant chemical warning labels for use in Europe. These templates are installed for European regions only.
Customize	Customize: Lets you determine which three (default) label types will display on the Home page.

Pipe Markers

Set Up Pipe Marker Options

Setup options for Pipe Markers are different than those for standard labels. Use this procedure to set up the pipe marker color norms.

To setup pipe marker color norms:

1. From the *Home* page, touch the **Pipe Markers** button. 

- or -

Touch the **More Label Types** button, then touch the **Pipe Markers** button.

2. From the *Pipe Marker* home page, touch the **Menu** button.

3. Touch the **Setup** button. 

4. In the *Pipe Marker Preferences* dialog, choose the desired color norm:



Preference	Description
ANSI/ASME 2007	Current American pipe marker standard.
CAN/CGSB	National standard of Canada.
AS1345-1995	Australia & New Zealand standard for hazardous substances.
ANSI/ASME 1996	Previous American pipe marker standard.

5. When done, touch the **OK** button. Until changed, these settings will remain for all future labels.

Create Pipe Marker Labels

Use these procedures to create pipe marker labels. See “Set Up Pipe Marker Options” on page 108 for an explanation on setting color norm and other Pipe Marker preferences.

To create a pipe marker label:

- From the *Home* page, touch the **Pipe Markers** button. 
 - or -
 - Touch the **More Label Types** button, then touch the **Pipe Markers** button.
- From the *Pipe Marker* panel, touch the **Create New File** button. 
- From the *Pipe Marker Style* dialog, select one of the following pipe marker label types:

Label Type	Description
Standard	Label is placed along the length of the pipe. Contents include text and graphics. Flow direction is optional.
Rollform	Similar to standard pipe markers except designed to wrap around the circumference of the pipe.
Symbol or Arrow Type	<i>Symbol</i> repeats along the entire length of the label and wraps around the circumference of the pipe. <i>Arrow</i> wraps around the pipe and indicates the direction of flow.

- Perform the steps appropriate for your pipe marker style (see “Creating a Standard Pipe Marker” on page 110, “Creating a Rollform Pipe Marker” on page 113 or “Creating a Symbol or Arrow Tape Pipe Marker” on page 115).

Creating a Standard Pipe Marker

To create a standard pipe marker:

1. In the *Dimensions* dialog, choose a **Tape Width** that corresponds to the diameter of your pipe, then touch the **Next** button.
2. In the *Pipe contents* dialog, choose the type of material that will flow through the pipe, then touch the **Next** button.

The material selected determines the pipe marker colors based on the selected color norm in the Pipe Marker setup menu.

Note: The *Ribbon/Tape* information in the dialog indicates the ribbon and tape colors that should be installed for this type of label.

3. In the *Legend* dialog, enter the text you want to appear on the label, then touch the **Next** button. 

4. To enter special characters, click the **Special Characters** button  , then enter the character(s). See “*Entering Special Characters*” on page 53 for more detail.

If too many characters per line are used, a message will display prompting you to edit the text or lengthen the pipe marker.

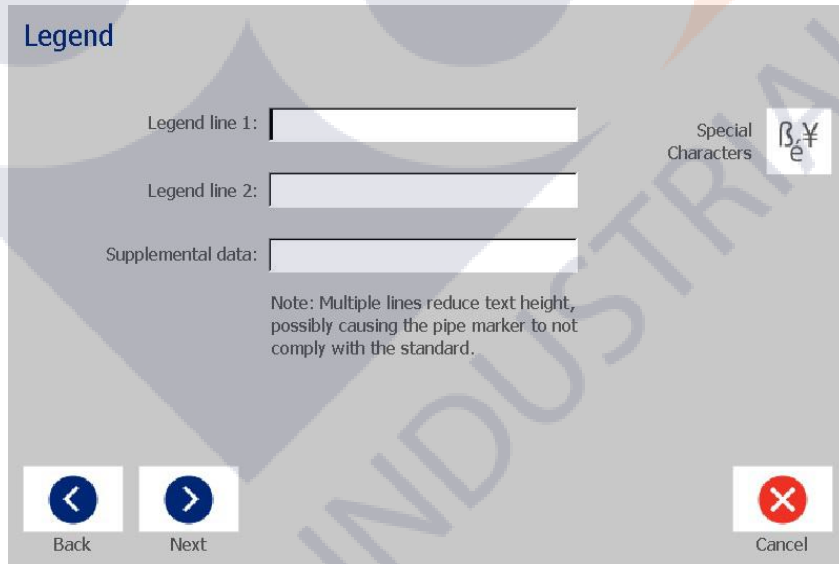

Legend



Legend line 1:

Legend line 2:

Supplemental data:

Note: Multiple lines reduce text height, possibly causing the pipe marker to not comply with the standard.

Special Characters 

  

Back Next Cancel

5. In the *Graphics* dialog:
 - a. Touch the graphic(s) you want to include on the label. A white line appears around the selected graphic(s) and the total number of selected graphics immediately updates. A maximum of 4 graphics are allowed.

Note: To deselect a graphic, touch the graphic again.

- b. If necessary, touch the **Change Category** button to choose from a different set of graphics. You can select graphics from more than one category.

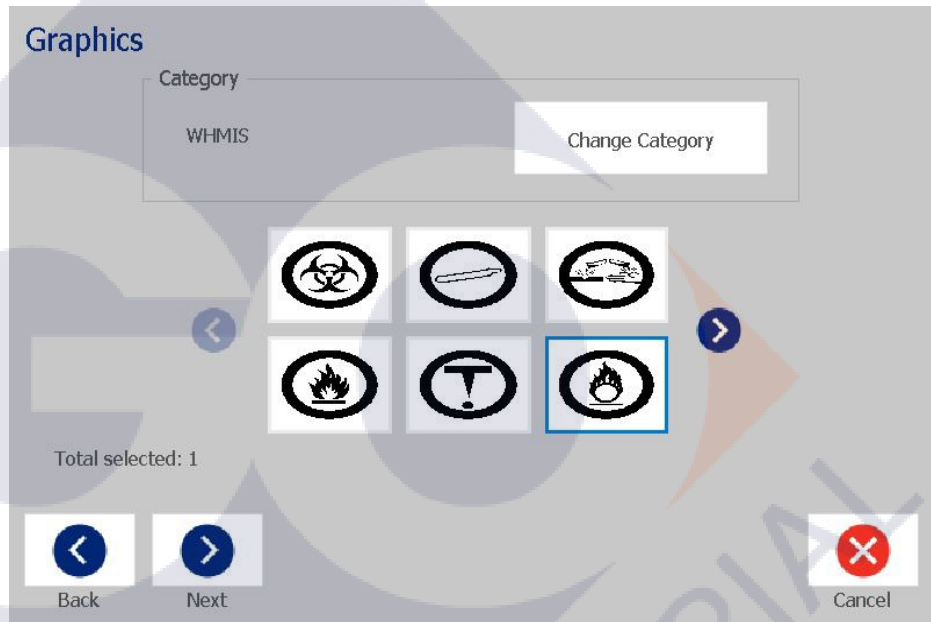

6. Touch the **Next** button. 

7. In the *Arrows* dialog, choose from the following options:
 - **Include:** *Before legend*, *After legend* (selecting both will include arrows both before and after the legend).
 - **Direction:** *Left*, *Right*, *Both*

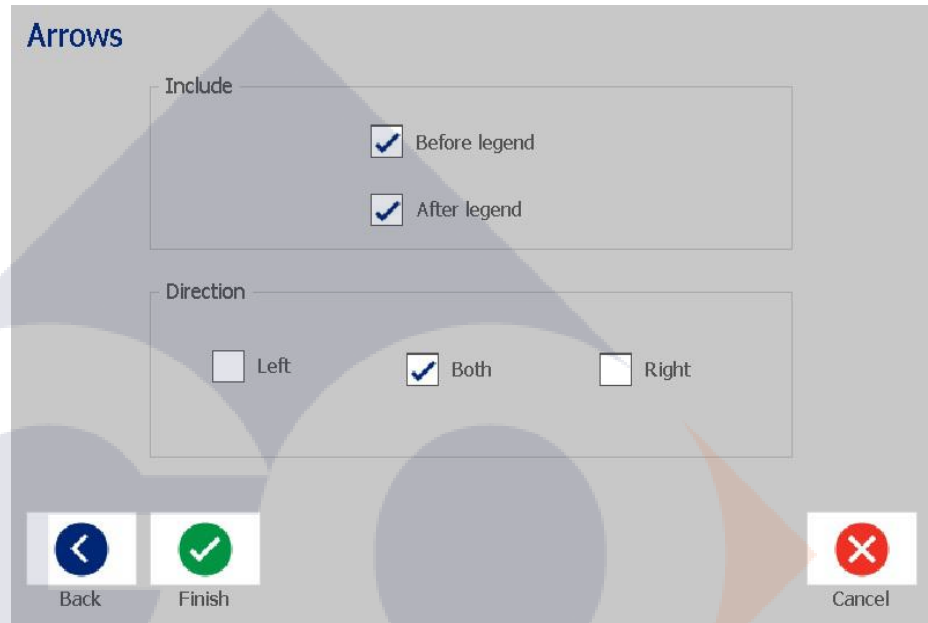

8. Touch **Finish**. The completed label will display in the Editor.
9. If desired, edit the data by touching the **Edit Pipe Marker Data** button  in the *Pipe Marker* control panel. Not all fields are editable.

Note: If the length of all elements together exceeds the recommended length, you will be prompted to edit the data or lengthen the pipe marker.

10. Install the correct ribbon and tape as necessary, and print the label.

Creating a Rollform Pipe Marker

To create a rollform pipe marker:

1. In the *Dimensions* dialog, enter the pipe diameter.
2. Choose a *Tape width* from the list, then touch the **Next** button.
3. In the *Pipe contents* dialog, choose the type of material that will flow through the pipe, then touch the **Next** button.

The material selected determines the pipe marker colors based on the selected color norm in the Pipe Marker setup menu.

Note: The *Ribbon/Tape* information changes to indicate the ribbon and tape colors that should be installed for this label.

4. In the *Legend* dialog, enter the text you want to appear on the label, then touch the **Next** button.

Sentences will line wrap as needed, however, long single words cannot wrap. Instead, the font will reduce to fit the whole word on the line.

5. To enter special characters, click the **Special Characters** button , then enter the characters. See “*Entering Special Characters*” on page 53 for more detail.

6. In the *Graphics* dialog:
 - a. Touch the graphics you want to include on the label. Selected graphics are highlighted and the total number of selected graphics immediately updates. A maximum of 4 graphics are allowed.

Note: To deselect a graphic, touch the graphic again.

- b. If necessary, press the **Change Category** button to choose from a different set of graphics. You can select graphics from more than one category.
7. Touch **Finish**.

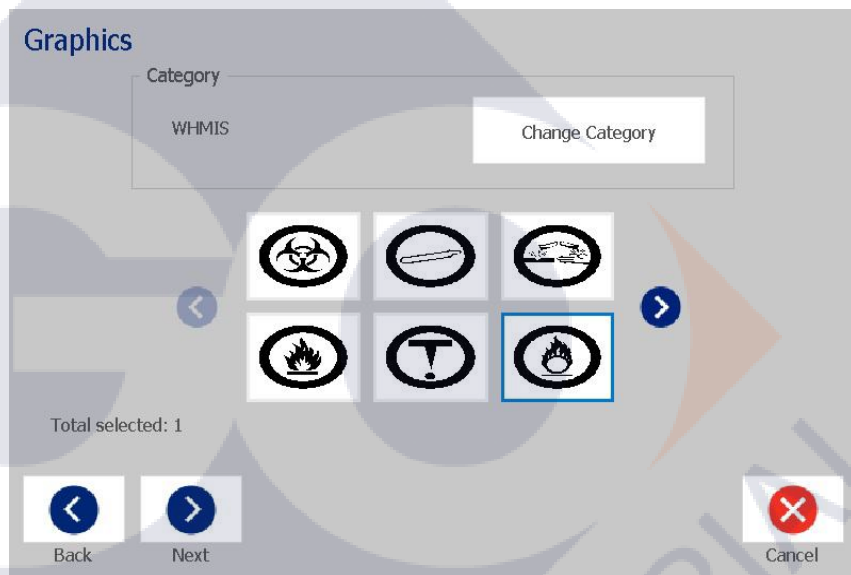

8. If desired, edit the data by touching the **Edit Pipe Marker Data** button  in the *Pipe Marker* control panel. Not all fields are editable.
9. Install the correct ribbon and tape as necessary, and print the label.

Creating a Symbol or Arrow Tape Pipe Marker

To create a symbol or arrow pipe marker:

1. In the *Dimensions* dialog, enter the pipe diameter.
2. Choose a *Tape width* from the list.
3. Touch the **Next** button. 
4. In the *Pipe contents* dialog, choose the type of material that will flow through the pipe, then touch the **Next** button.

The material selected determines the pipe marker colors based on the selected color norm in the *Pipe Marker* setup menu.

Note: The *Ribbon/Tape* information changes to indicate the ribbon and tape colors that should be installed for this label.

5. In the *Symbol Type* dialog, choose the symbol type:
 - a. Touch the **Arrow** button, then touch the **Finish** button.
 - or -
 - b. Touch the **Symbol** button, then choose a category and graphic. As soon as you select a graphic, the label will be created and displayed in the *Editor*.
6. Install the correct ribbon and tape as necessary, and print the label.

Save, Open or Delete a Pipe Marker Label



You can only save, open or delete pipe marker labels from the Pipe Marker application.

To open the pipe marker application:

1. From the *Home* page, touch the **Pipe Markers** button. 
- or -
- Touch the **More Label Types** button, then touch the **Pipe Markers** button.

To save a pipe marker:

Note: This procedure assumes that a pipe marker has already been created. To create a pipe marker, see “*Create Pipe Marker Labels*” on page 109.

1. With the pipe marker displayed in the *Pipe Marker* control panel, touch the **Menu** button.
2. Touch the **Save File** button. 
3. Select a category, or if desired, create a new category.
4. In the *File name* field, enter a file name for the pipe marker.
5. Touch the **OK** button . The pipe marker is saved.

To open an existing pipe marker:

1. From the *Pipe Marker* control panel, touch the **Open Saved File** button. 
2. In the *Open File* dialog, select a category.
3. Select a label. The file immediately opens in the pipe marker editor.
4. To edit the pipe marker, touch the **Edit Pipe Marker Data** button.

To delete a pipe marker:

1. In the *Pipe Marker* control panel, touch the **Menu** button.
2. Touch the **Delete File** button. 
3. In the *Delete File* dialog, select the category where the label is located.
4. Select the label you want to delete.
5. When prompted to delete the file, touch **Yes**. Selecting *No* will cancel the operation.

PreMade Labels - North America

Creating PreMade Labels

PreMade Labels is an application that lets you choose from a list of predefined labels. Use this procedure to open PreMade Labels.

To create a label with PreMade Labels:

1. From the *Home* page, touch the **PreMade Labels** button. 
 - or -
 - Touch the **More Label Types** button, then touch the **PreMade Labels** button.
2. From the *Select Label* dialog, enter the **Label ID**, then touch **OK**.

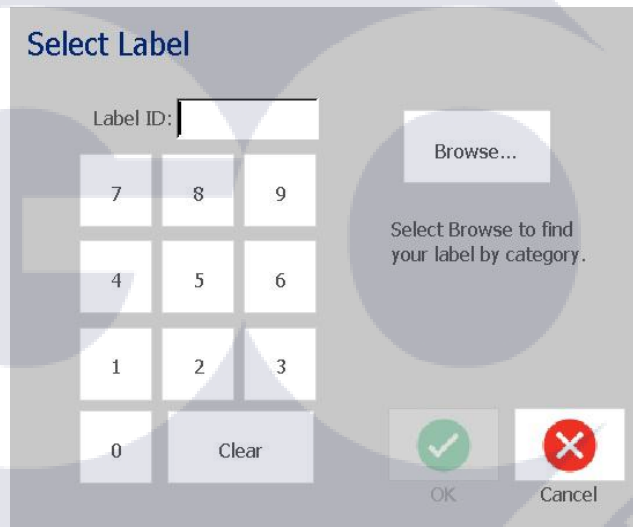

- or -

Touch the **Browse** button, choose a category, then select the label you want. The label immediately opens in the *Editor*. See “*PreMade Labels Reference Images - North America*” on page 118 for examples of available pre-defined labels.

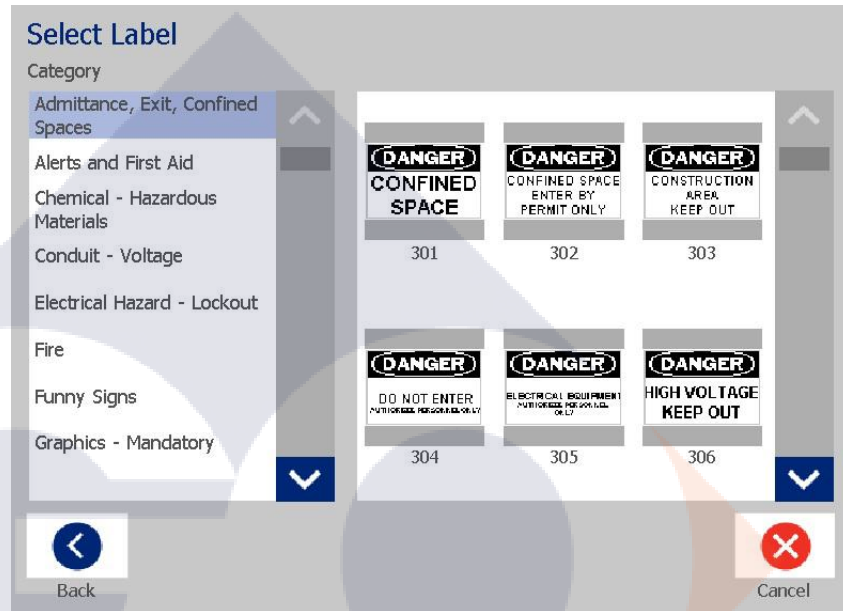

3. If desired, edit the label using the normal editing procedures. See “*Working with Labels*” on page 27 and “*Working with Objects*” on page 37 for more information.
4. To open, save or delete a pre-defined label, see “*Working with Label Files*” on page 73.

PreMade Labels Reference Images - Europe

For information about the available labels for Europe, contact your local Sales Representative.

Note: PreMade Labels for Europe are available only in French, German, Italian and Dutch.

PreMade Labels Reference Images - North America

Reference the following labels when creating PreMade Labels.

Admittance, Exit, Confined Spaces



Alerts and First Aid



326 – 4" x 6"



327 – 4" x 6"



328 – 4" x 10"



329 – 4" x 10"



330 – 4" x 10"



331 – 4" x 6"



332 – 4" x 6"

Chemical - Hazardous Materials

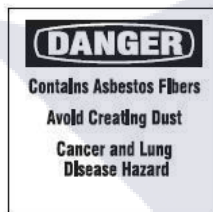

333 – 4" x 4"



334 – 4" x 6"



335 – 4" x 6"



336 – 4" x 6"

Conduit - Voltage



408 - 2.25" x 9"



409 - 2.25" x 9"



410 - 2.25" x 9"



411 - 2.25" x 9"



412 - 2.25" x 9"

Electrical Hazard - Lockout



337 - 3" x 5"



338 - 3" x 5"

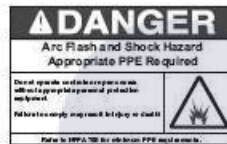

339 - 3" x 5"



340 - 3" x 5"

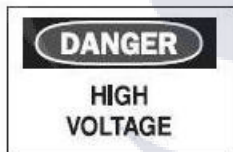

341 - 4" x 6"



342 - 6" x 4"



343 - 8" x 4"



344 - 6" x 4"



345 - 6" x 4"



350 - 8" x 4"

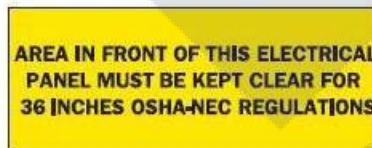

351 - 4" x 10"



352 - 3" x 5"



354 - 2.25" x 5"



355 - 2.25" x 5"



356 - 2.25" x 5"

Fire



361 - 4" x 14"



362 - 4" x 14"



358 - 4" x 6"



359 - 4" x 6"



363 - 4" x 6"



365 - 4" x 10"

Funny Signs



366 - 4" x 6"



367 - 4" x 6"



368 - 4" x 6"



371 - 6" x 4"



372 - 4" x 6"

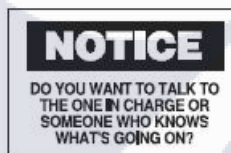

369 - 4" x 6"



370 - 4" x 6"

Graphics - Mandatory



Graphics - Packaging



046



047



048



049



050



051



052

Graphics - PPE



027



028



029



030



031



032



033



034



035



036



037



038



039



040



041



042



043



044



045

Graphics - Prohibition



Graphics - Signal Words



Graphics - Warning

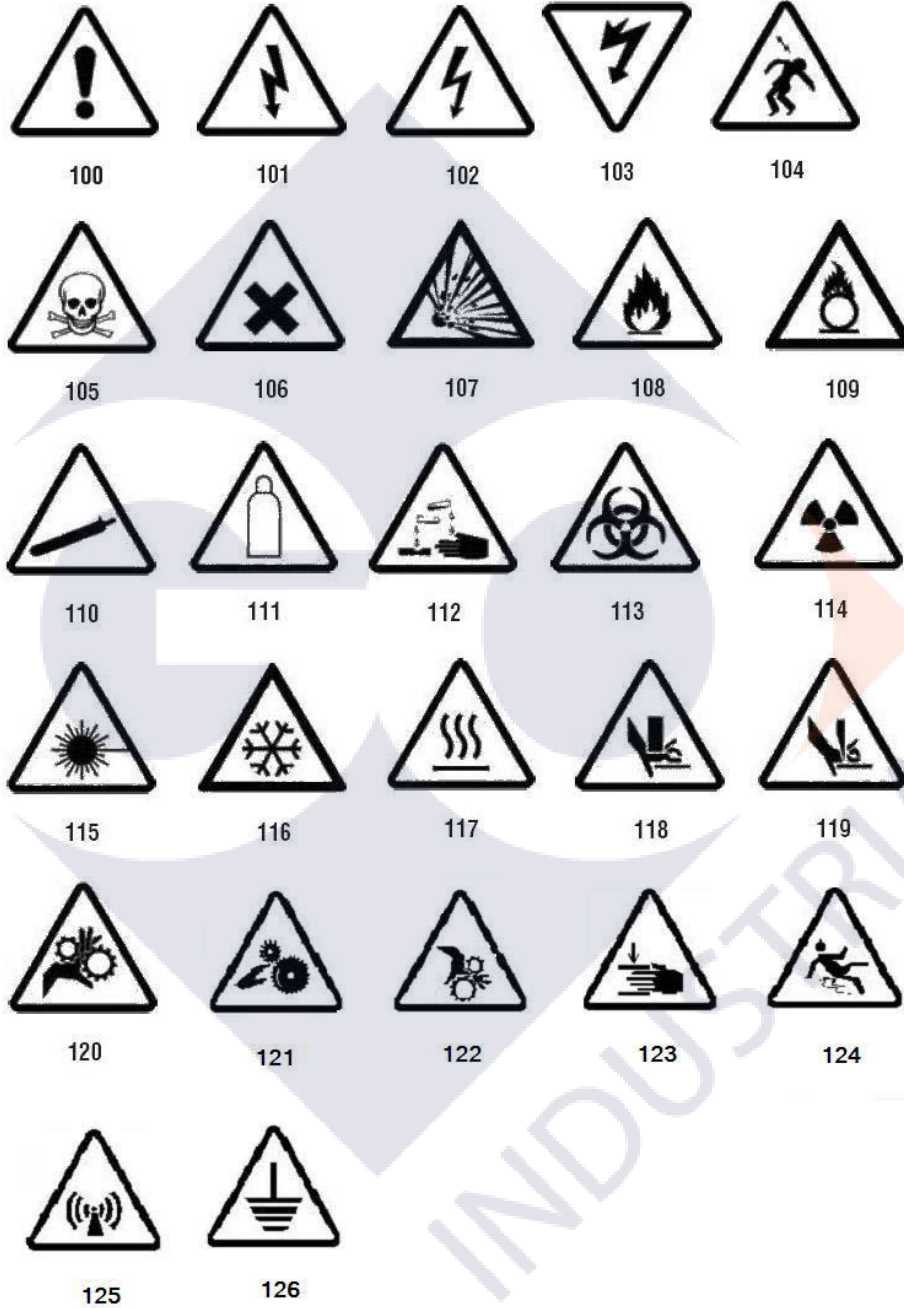

Inspection



402 – 0.5" x 2"



403 – 0.5" x 2"

Machine - Operational



374 – 4" x 6"



376 – 4" x 6"



378 – 4" x 6"



379 – 4" x 6"



380 – 4" x 6"



381 – 4" x 6"



382 – 4" x 6"



384 – 4" x 6"

No Smoking



385 – 4" x 6"



386 – 4" x 6"



387 – 4" x 6"



388 – 6" x 4"



389 – 4" x 6"

Pipe Marker Arrows



595



599



603



607



611



615



619



623



637

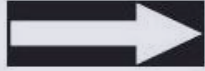

638

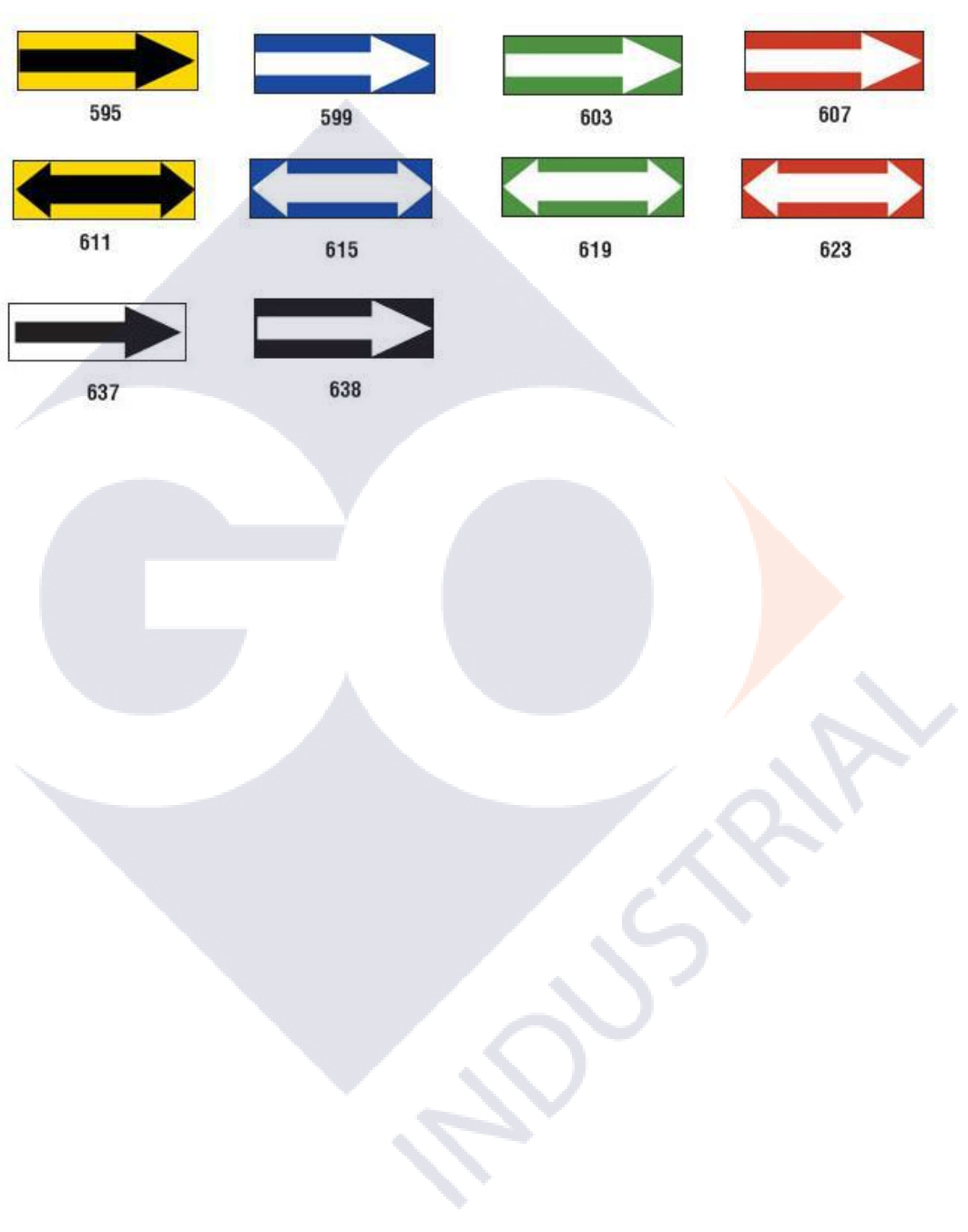

Pipe Markers



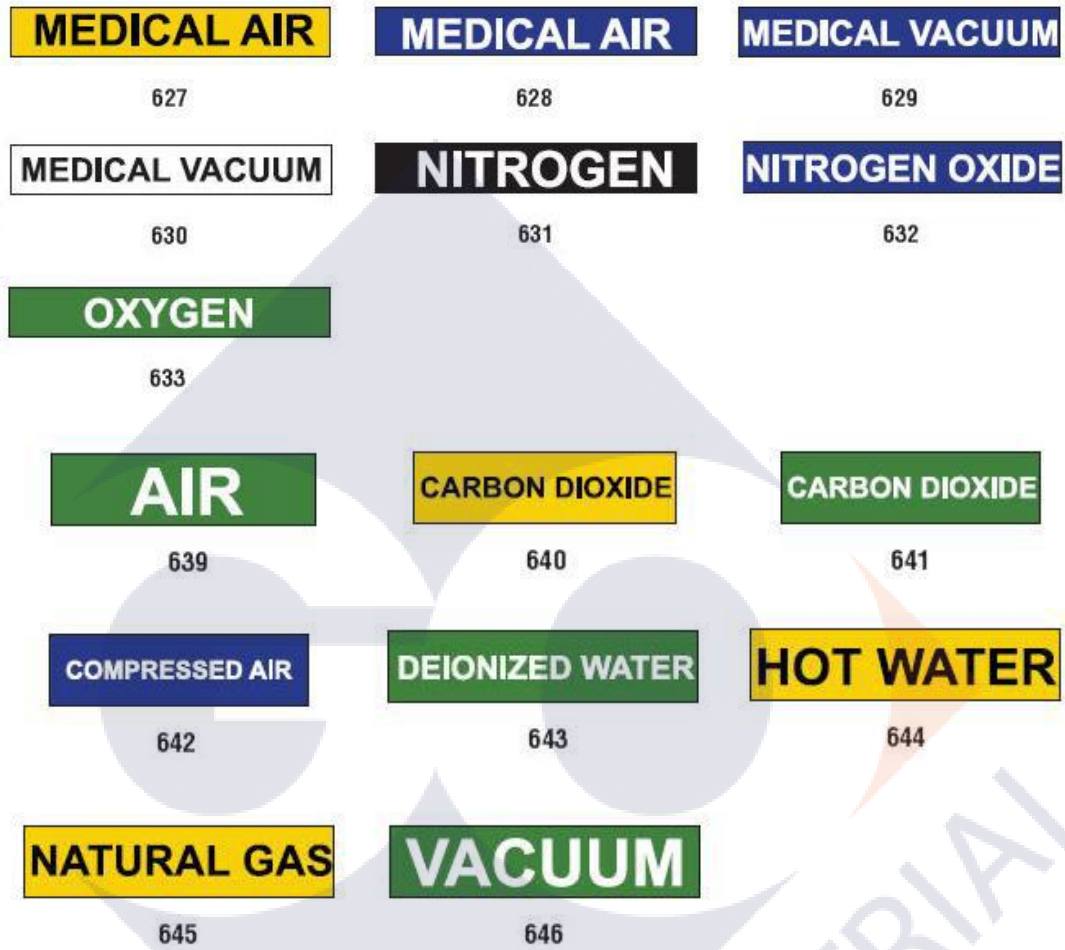

Protective



Warning Stakes

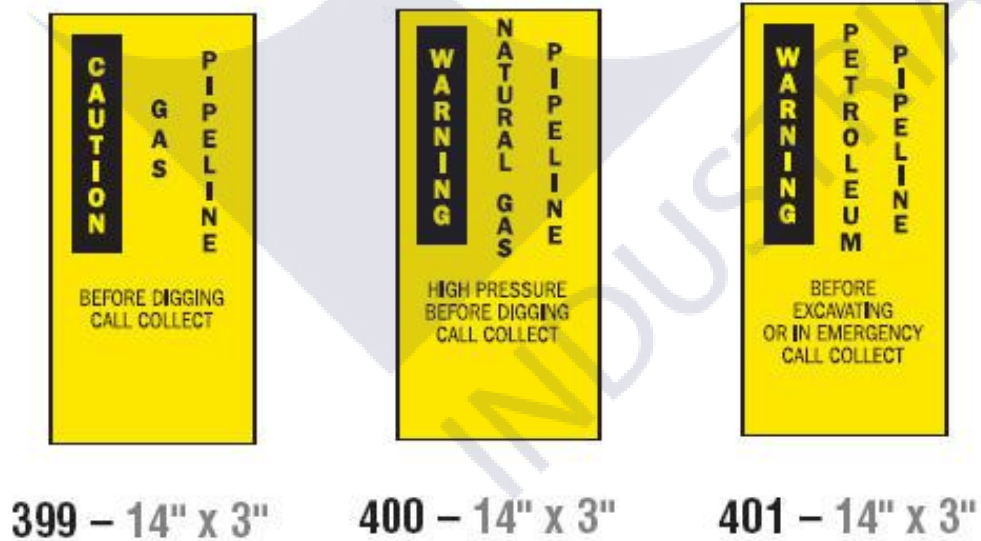

Right to Know (RTK)

Setting RTK Preferences

From the *Right-to-Know Preferences* menu, you can choose default label settings for size and format. You can also add or delete hazards and/or organ types. Any defaults set here will stay in effect until you change them.

1. From the *Home* page, touch the **Right To Know** button.



- or -

Touch the **More Label Types** button, then touch the **Right To Know** button.

2. From the *Right To Know* home page, touch the **Menu** button.

3. Touch the **Setup** button . Choose from any of the available options, then follow the instructions in “*Set Label Defaults*” on page 134 or “*Add or Delete Hazards or Organs*” on page 135.

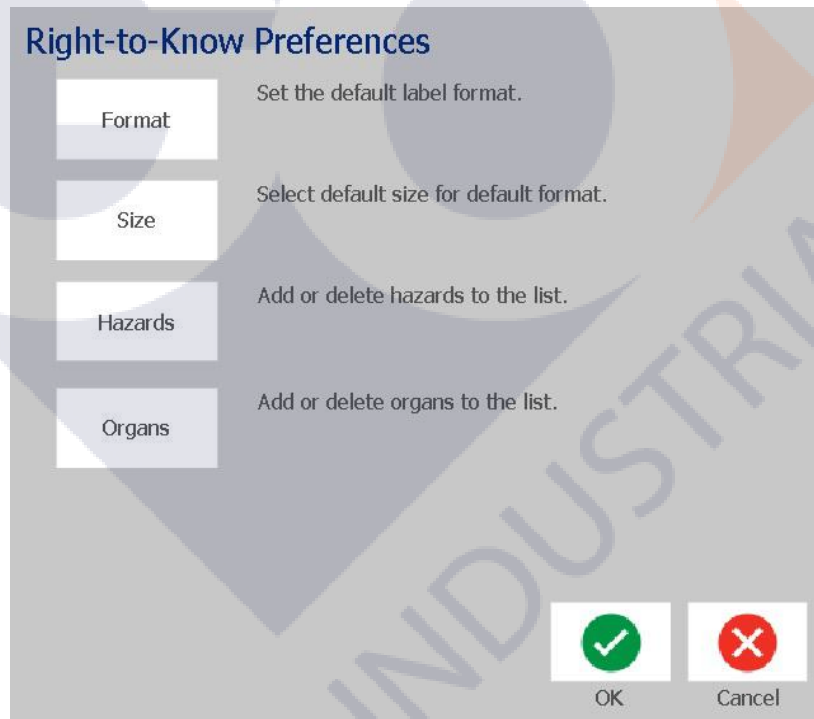

Set Label Defaults

Format

To setup a default label format:

1. In the *Right-to-Know Preferences* dialog, touch the **Format** button.
2. In the *Right-to-Know Format* dialog, choose a format type from the list. An example of the highlighted format type will display on the right side of the screen.
3. Click the **OK** button. ✓
4. Click the **OK** button ✓ again to close the dialog and return to the main page.

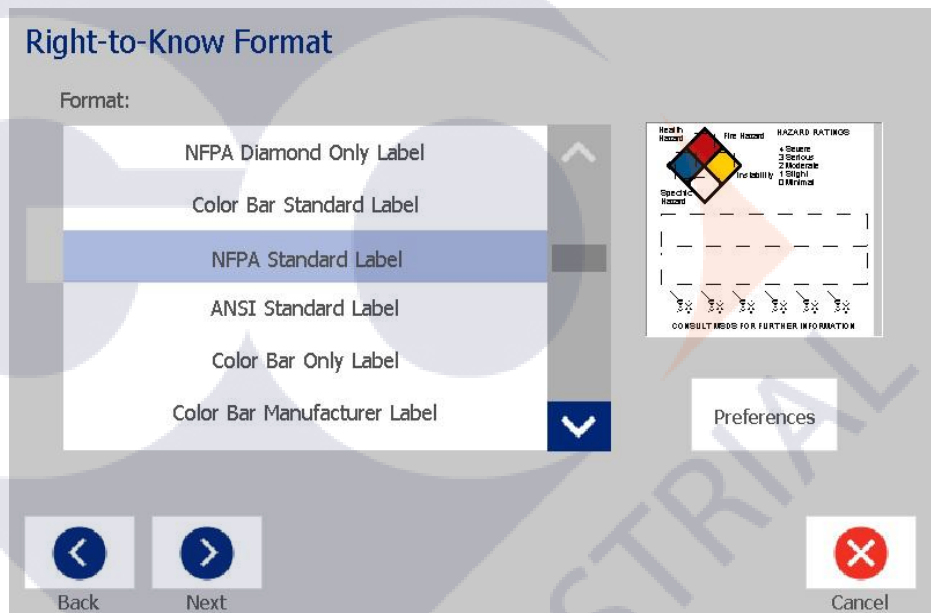

Size

To choose a default label size:

1. In the *Right-to-Know Preferences* dialog, touch the **Size** button. 
2. From the *Standard Label* options for the selected format type, choose the label size you want.

Note: The available label sizes are determined by the format type you have selected.

3. Click the **OK** button. ✓
4. Click the **OK** button ✓ again to close the dialog and return to the main page.

Add or Delete Hazards or Organs

Hazard Types

To add a hazard type:

1. In the *Right-to-Know Preferences* dialog, touch the **Hazards** button.
2. In the *Add or delete hazards* dialog, type the new hazard you want to include.
3. Touch the **Add** button. The hazard will be added to the list.

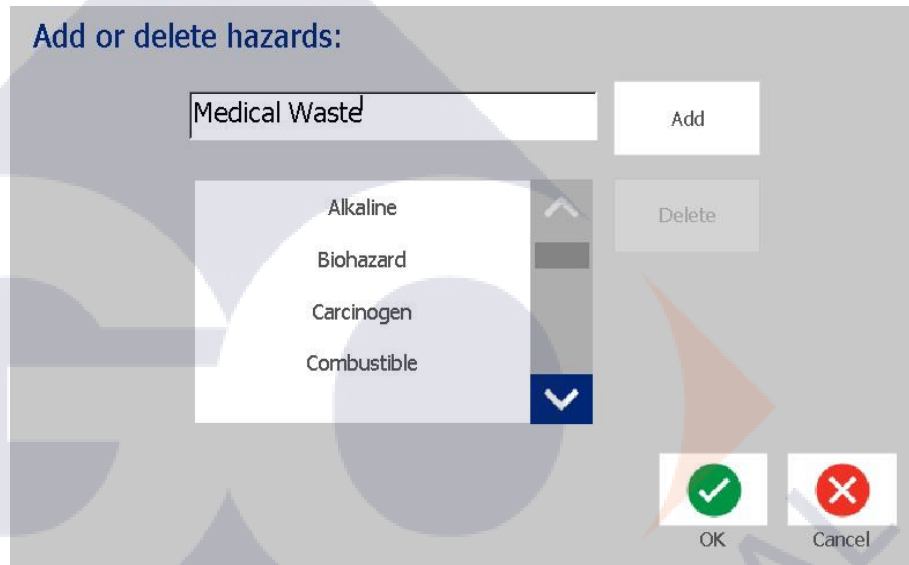

To delete a hazard type:

1. In the *Right-to-Know Preferences* dialog, touch the **Hazards** button.
2. In the *Add or delete hazards* drop-down list, choose the hazard you want to delete, then touch the **Delete** button. 

Organ Types

To add an organ type:

1. In the *Right-to-Know Preferences* dialog, touch the **Organs** button.
2. In the *Add or delete organs* dialog, type the new organ you want to include.
3. Touch the **Add** button. The organ will be added to the list.

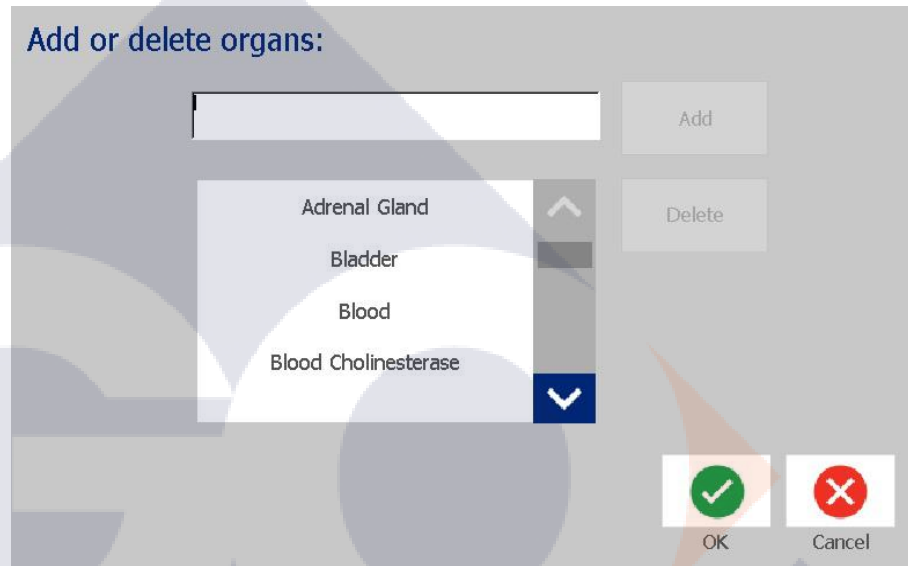

To delete an organ type:

1. In the *Right-to-Know Preferences* dialog, touch the **Organs** button.
2. In the *Add or delete hazards* drop-down list, choose the organ you want to delete, then touch the **Delete** button. 

Create RTK Labels

The selected label format determines the options that are available. See *Table C.1 “Available RTK Formats and Options”* on page C-139 for a list of formats and options that are available from the RTK menu.

To create a new RTK label:

1. From the *Right To Know* panel, touch the **Create New File** button. 

Note: Depending on the defaults selected in the *Setup* menu, the defaults selected will vary. To change the selected defaults, see “*Setting RTK Preferences*” on page 133.

2. Select a new label format, or click the **Next** button  to continue with the default selection.

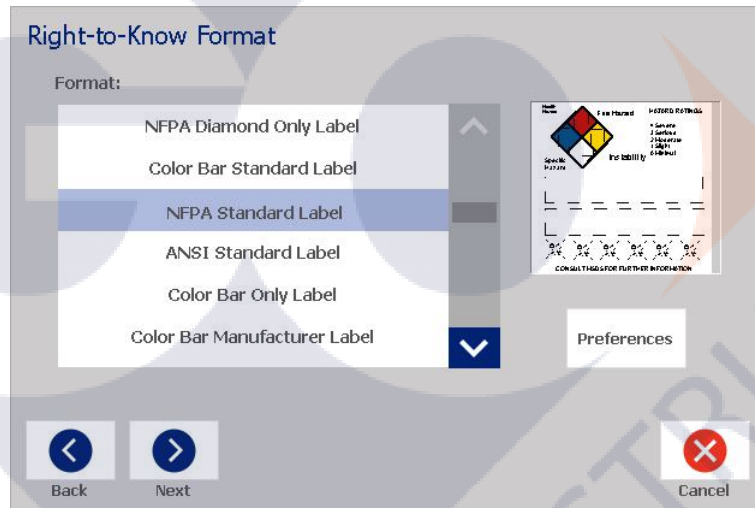

3. Select or enter data for each of the dialogs that display for your label format. The dialogs that display depend on the label format you selected.
4. When done, touch the **Finish** button. The label is generated and displayed in the *Editor*.

Note: Before printing, install the supply that matches the label you are creating.



5. To edit or change the objects, touch the **Edit RTK Data** button. 
6. In the dialog(s) that display, select or enter the new data, then click the **Next** or **Finish** button.

Note: The format cannot be edited after a label has been created.

Open, Save or Delete an RTK Label

You can only save, open or delete RTK labels from the Right To Know (RTK) application.

To open an existing RTK label:

1. From the *Home* page, touch the **Right To Know** button. 
- or -
Touch the **More Label Types** button, then touch the **Right To Know** button.
2. From the *Right To Know* control panel, touch the **Open Saved File** button.
- 
3. In the *Open File* dialog, choose a category.
4. Select a label. The file immediately opens in the *Editor*.

To save an RTK label:

Note: This procedure assumes that an RTK label has already been created. To create an RTK label, see “*Create RTK Labels*” on page 137.

1. With the RTK label displayed in the *Editor*, touch the **Menu** button.
2. Touch the **Save File** button. 
3. Select a category, or if desired, create a new category.
4. In the *File name* field, enter a file name for the RTK label.
5. Touch the **OK** button . The RTK label is saved.

To delete an RTK label:

1. In the *Right To Know* control panel, touch the **Menu** button.
2. Touch the **Delete File** button. 
3. In the *Delete File* dialog, choose the category where the label is located.
4. Touch the label you want to delete.
5. When prompted to delete the file, touch the **Yes** button. Selecting *No* will cancel the operation.

Table C.1 Available RTK Formats and Options

RTK Formats	Available Options*	Description
NFPA Diamond Only Color Bar Standard NFPA Standard ANSI Standard Color Bar Only Color Bar Manufacturer NFPA Manufacturer NFPA Tag - One Sided NFPA Tag - Two Sided Color BarTag - One Sided Color BarTag - Two Sided	Size	Select a label size for the chosen format.
	Chemical Name / Name	Enter the chemical description.
	Common Name	Enter a common name for the chemical.
	Health Hazard Rating	Select standard ratings ranging from none to severe, if applicable
	Fire Hazard Rating	
	Instability (reactivity) Rating	
	Specific Hazard Rating	Select specific hazard rating type, if applicable.
	CAS#/Title	Enter the chemical identification number and/or title.
	Synonym	Enter an alternate name for the chemical.
	Signal Word	Select a standard OSHA signal word (danger, warning, caution), if applicable.
	Physical & Health Hazards	Select hazards to health and/or physical body.
	Target Organs	Select organs affected. The list includes target organs for the selected chemical.
	Comments	Add relevant comments to your label.
	Graphics	Add graphic(s). Graphics are sorted by category.
	Statement of Hazard	Enter a statement of the hazard (displays in all caps on label).
	Precautionary Statements	Specify any precautions.
	Effects of Overexposure	Describe condition that will result from overexposure.
	First Aid Procedures	Provide first aid information.
	Protective Equipment	Designat protective equipment codes and manufacturers for Color Bar and NFPA labels.
	Manufacturer	Enter manufacturer of chemical, if known.
Temperature	Enter temperature that you want printed on the label.	
Date	Enter the date.	



*Available options depend on the RTK format selected.

GHS (CLP)

CLP is the regulation on classification, labeling and packaging of substances and mixtures. This regulation aligns previous EU legislation on classification, labeling and packaging of chemicals to the GHS (Globally Harmonised System of Classification and Labeling of Chemicals). Its main objectives are to facilitate international trade in chemicals and to maintain the existing level of protection of human health and environment.



To create a GHS/CLP label:

1. From the Home page, in the control panel, touch the **More Label Types** button.
2. In the list of label types, touch the **GHS (CLP)** button. 
3. In the control panel, touch the **Create New File** button. 
4. Under *Select Template*, touch the desired template format, then touch the **Next** button. 
5. On the *Select Label Size and Type* dialog box, touch the **Next** button again. You cannot change the label type because monochrome is the only option with this printer.
6. Touch anywhere on the displayed label to bring up the *CLP (GHS) Data* dialog box.

GHS (CLP) Data

Primary Language

Product Name: Sulphuric Acid 96 %

Second Language

Second language: French

Product Name: Acide sulphurique 96 %

OK Cancel

7. In the **Product Name** field, enter the name of the chemical (product) you want to use.
OR, if chemical names have been saved (previously used):
Under *Primary Language*, touch the down arrow next to *Product Name* to display a list of products, then touch the desired product.
8. If a second language is to be used on the label, under *Second Language*:
 - a. Select the **Second Language** check box.
 - b. Touch the down arrow next to the *Second Language* field to display a list of languages.
 - c. Use the up and down arrows to scroll through the list, and touch the desired second language.

If using a second language, the product name automatically displays in the chosen language.
9. Touch the **OK** button. 
10. On the displayed label, touch one of the statements to bring up the *CLP (GHS) Statements* dialog box.
11. Touch the **Add** button for the type of statement you want to add (Hazardous, Precautionary, Supplementary).
12. On the *Select Hazardous Statements* screen, touch the up and down arrows in the scroll bar to view more statements and select the check box for each statement that you want to use.

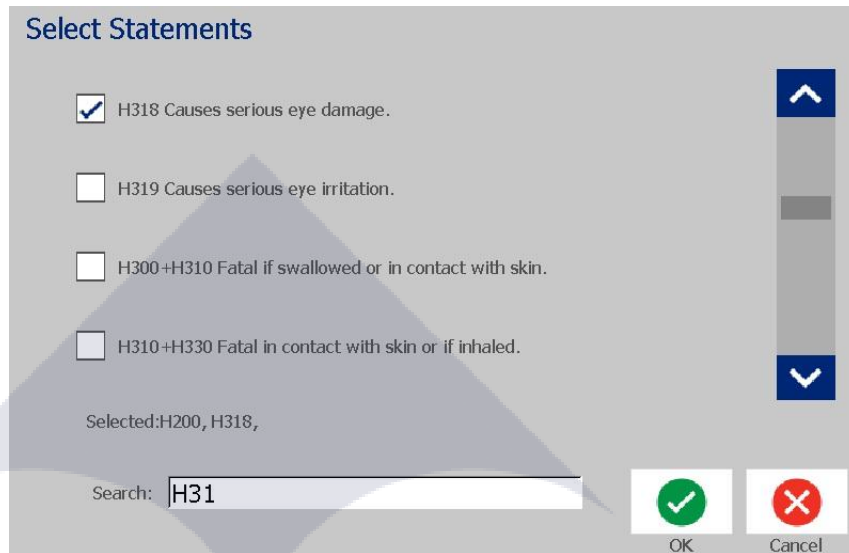

Alternatively, if you know the code number or wording of the statement you want to use:

- a. Touch the **Search** field and enter the number or wording. As you enter data in the Search field, the list updates to show those statements that have the entered characters in that position in their statement. The list narrows after each letter entered.
- b. In the filtered list, touch the check box in front of the statement you want to use. (You can select more than one.)

13. When ready, touch the **OK** button. 

14. Repeat Steps 11 through 13 for other statements that you want to add.

15. To remove a previously added statement, touch the **Clear** button for each statement that you want to remove.

16. When complete, touch the **Finish** button. 

The label displays the added statements.

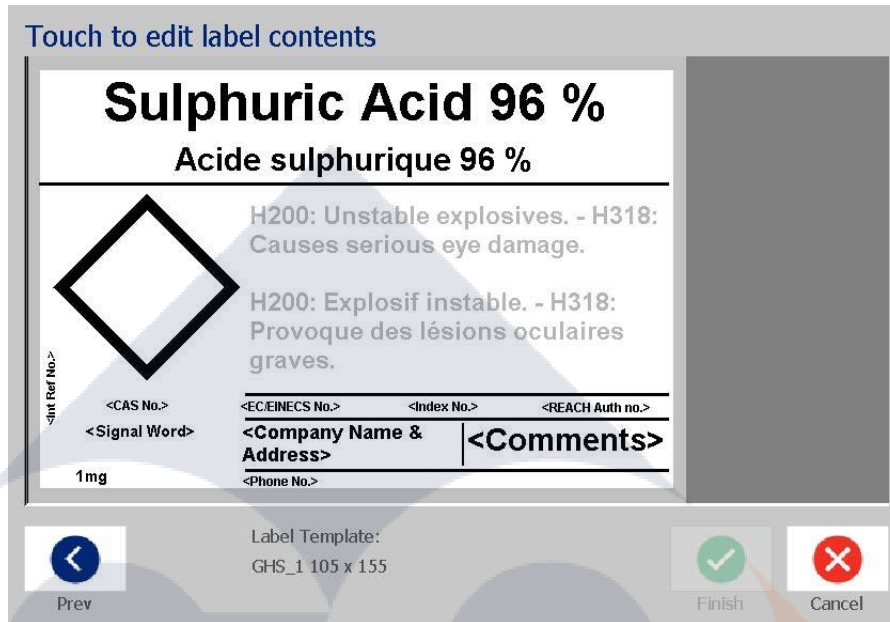

17. There are other fields on the label where you can add custom data. These fields are designated by brackets < >. To add the suggested custom information:

- a. On the label, touch the desired custom field (inside the brackets).
- b. A dialog box displays where you can enter the requested information.
- c. Touch the desired data field and enter the data.
- d. When finished with the particular data screen, touch the **OK** button.



18. Touch an empty diamond on the label to add a graphic.

- a. Graphics are organized by category. Touch **Change Category** and the select the category from which you need a graphic. Touch the **OK** button.
- b. Touch the graphic that you want to use. You may need to touch the right and left arrow keys to scroll through all the graphics in the selected category.

- c. Touch the **Finish** button.



19. When finished with the entire label, touch the **Finish** button.



Note: If the *Finish* button is not available, make sure that the product name is entered, that at least one hazard or precaution statement is selected, and that the graphics have been specified.

D Material / Ribbon Cross Reference

BradyPrinter S3100 Material / Ribbon Cross Reference Guide						
Material		Ribbon				
		● = Recommended Δ = Acceptable				
Brady Material #	Material Description	B30-R10000 (Black, Colors)	B30-R6000 (Black)	B30-R6200 (Black)	B30-R4300 (Black)	B30-R4400 (White)
B-423	Polyester		●	Δ		
B-424	Paper				●	
B-428	Metallized Polyester				●	
B-432	Clear Polyester		●			Δ
B-434	Metallized Polyester		●			
B-437	Polyvinyl Fluoride				●	
B-438	Tamper-Evident Metallized Polyester	Δ			●	
B-483	Polyester		●			
B-484	Flexible Polyester		●			
B-486	Metallized Polyester				●	
B-488	Polyester				●	
B-489	Polyester				●	
B-509	Magnetic	●	Δ			
B-526	Phosphorescent	●	Δ			
B-549	Cold Temperature	●	Δ			
B-551	Tag Stock	●	Δ			
B-565	Metallized Polyester	●	Δ			
B-569	Hi-Performance Polyester	●	Δ			Δ
B-581	Repositional Vinyl	●	Δ			
B-584	Reflective Tape	●	Δ			Δ
B-593	Adhesive Taped Polyester		●			Δ
B-595	Indoor/Outdoor Vinyl Tape	●	Δ			Δ
B-724	Polyimide				●	

BradyPrinter S3100 Material / Ribbon Cross Reference Guide						
Material		Ribbon				
		● = Recommended Δ = Acceptable				
Brady Material #	Material Description	B30-R10000 (Black, Colors)	B30-R6000 (Black)	B30-R6200 (Black)	B30-R4300 (Black)	B30-R4400 (White)
B-727	Polyimide		●			
B-7563	Metallized Polyester		●	Δ		
B-7569	Vinyl Film	●	Δ			Δ
B-787	Polyvinyl Fluoride		●			
B-854	Metal Detectable Polyester		●			
B-855	ToughWash® Polyester		●			





