

elcometer[®]
inspection equipment



Elcometer 510
Automatic Adhesion Gauge

Elcometer 510

Automatic Pull-Off Adhesion Gauge

The Elcometer 510 Automatic Pull-Off Adhesion Gauge accurately measures the strength of the bond between the coating and the substrate.

STANDARDS:
ASTM C1583, ASTM D4541,
ASTM D7234-12, AS/NZS 1580.408.5,
BS 1881-207, DIN 1048-2,
EN 1015-12, EN 12636, EN 13144,
EN 1542, EN 24624, ISO 16276-1,
ISO 4624, JIS K 5600 5-7, NF T30-606,
NF T30-062

Hand-held, waterproof rugged design equivalent to IP64

Automatic hydraulic pump ensures smooth and continuous pressure application for consistent, repeatable results

Fully adjustable pull rates 0.1-1.4MPa/s (15-203psi) to meet National and International Standards

User definable measurement range with an accuracy of ±1% of full scale:
10mm dolly: 100MPa / 14400psi
14.2mm dolly: 50MPa / 7200psi
20mm dolly: 25MPa / 3600psi
50mm dolly: 4MPa / 580psi

10, 14.2, 20 and 50mm diameter dolly options

User definable limits with unique pressure hold and release function

Store up to 60,000 readings with individual pull graphs in up to 2,500 alpha numerical batches, complete with attribute failure information

Intuitive & easy to use menu structure in multiple languages

Suitable for use in Cloud Computing

2 YEAR* WARRANTY



Elcometer 510 Model T: Made for iPhone 6 Plus, iPhone 6, iPhone 5s, iPhone 5c, iPhone 5, iPhone 4s, iPhone 4, iPad Air 2, iPad mini 3, iPad Air, iPad mini 2, iPad (3rd and 4th generation), iPad mini, iPad 2, and iPod touch (4th and 5th generation). "Made for iPod," "Made for iPhone," and "Made for iPad" mean that an electronic accessory has been designed to connect specifically to iPod touch, iPhone, or iPad, respectively, and has been certified by the developer to meet Apple performance standards. Apple is not responsible for the operation of this device or its compliance with safety and regulatory standards. Please note that the use of this accessory with iPod touch, iPhone, or iPad may affect wireless performance.

Automatic Pull-Off Adhesion Gauge

Elcometer 510

Powerful

- Suitable for use on metal, wood, concrete and other substrates
- Smooth load application up to 100MPa (14400 psi)
- USB and Bluetooth® data output to iOS† or Android™ devices
- Stores up to 60,000 readings in 2,500 batches

Durable

- Sealed, heavy duty and impact resistant
- Dust and waterproof equivalent to IP64
- Suitable for use in harsh environments

Efficient

- Ideal for laboratory and field use
- 10, 14.2, 20 and 50mm (0.39, 0.56, 0.76 & 1.96") diameter reusable dollies
- Compatible with ElcoMaster® and ElcoMaster® Mobile App
- Measures on small, curved and flat surfaces

Accurate

- Measurement range up to 100MPa (14400 psi) with an accuracy of $\pm 1\%$ of full scale
- Can be used in accordance with National & International Standards



* Elcometer 510 gauges are supplied with a one year warranty against manufacturing defects. The warranty can be extended to two years via www.elcometer.com

† Compatible with iPod, iPhone and iPad.

Elcometer 510

Automatic Pull-Off Adhesion Gauge

Key Features Explained

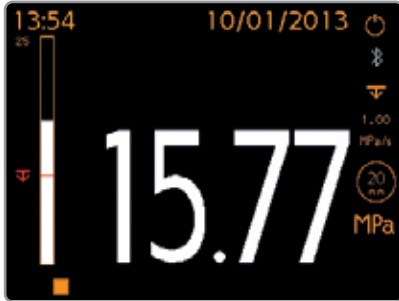

Automatic adhesion tester with selectable pull rates for 10, 14.2, 20 & 50mm diameter dollies.



View trend graphs or live statistics alongside the reading value.



Individual user definable pull rate graphs can be saved with each reading.



Stores individual readings and pull rate graphs in up to 2,500 alpha numeric batches, together with date, time and attribute information.



Either pull to maximum or pull to preset limit. Unique time hold feature allows users to set a delay before pressure returns to zero.

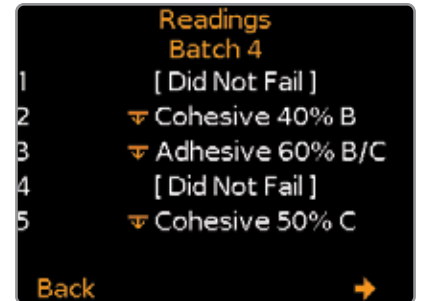

Save cohesive and adhesive failure attributes alongside your adhesion pull data in accordance with National and International Standards.



Testing coatings on low bond strength substrates

When testing coatings on low bond strength substrates such as concrete, wood or other fibrous materials, a larger surface area of dolly (50mm) is required to provide accurate, repeatable and reproducible results.

The Elcometer 510 is available as a Concrete Adhesion Tester Kit, or 50mm accessory items (skirt, dolly, cutter) can be added to existing Elcometer 510 adhesion kits.

Automatic Pull-Off Adhesion Gauge

Elcometer 510



Powered by either standard rechargeable batteries or AC mains*. Each battery charge performs up to 200 pulls. Battery recharge time <300 minutes.



Transfer data to your PC via USB or Bluetooth® for further analysis with ElcoMaster® software or view live pull rate graphs in ElcoMaster® during the test.



Using wireless Bluetooth® communication link the gauge to an Android™ or iPhone® mobile device. Live GPS coordinates from your mobile device can be added to reports and emailed instantly.



A range of interchangeable thin & standard substrate skirt adaptors allow each gauge to be used with 10, 14.2, 20 or 50mm diameter reusable dollies, ideal for testing coatings on thin, thick, flat or convex substrates.



The optional magnetic anchor clamp ensures the actuator doesn't fall during tests on vertical surfaces or testing at height.



Supplied in a robust plastic carry case for easy transportation to and around the job site.



Adhesion Verification Unit for Verification in the Field

The Elcometer 510 gauge's inbuilt Adhesion Verification feature allows users to connect the gauge to the Elcometer AVU to verify gauge accuracy in the field.

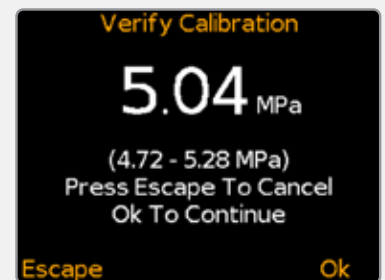

* Model T only.

‡ iPod, iPhone and iPad compatible.

Elcometer 510

Automatic Pull-Off Adhesion Gauge

Assessing The Results - Failure Attributes

Many National and International Standards, including ISO 4624 & ASTM D4541, require the user to record not only the pull-off force but also the nature of the failure. This is done by examining the bottom of the dolly and assessing the failure. In 'Advanced' mode on the Elcometer 510 it is possible to select the 'Attributes' feature (Menu/Setup/ Gauge Mode/Advanced) allowing the nature of the fracture to be recorded against each reading and stored within the batch.

Examining The Dolly

- a) Cohesive Failure: The coating fails within the body of a coating layer leaving the same coating on the surface and on the dolly face.
- b) Adhesive Failure: Failure occurs at the interface between layers (intercoat) where one pulls away from the other. The "coating" on the dolly face will not be the same as that on the test area.
- c) Glue Failure: When no coating is present on the dolly it must be recorded as a failure of the glue. This may be due to incorrect or insufficient mixing of the component parts of the adhesive, incompatibility between the adhesive/coating/dolly/test surface.

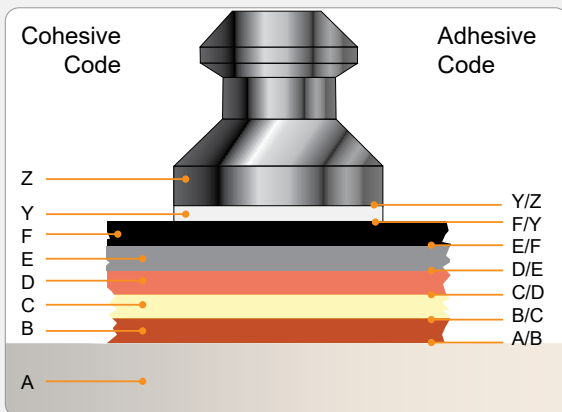
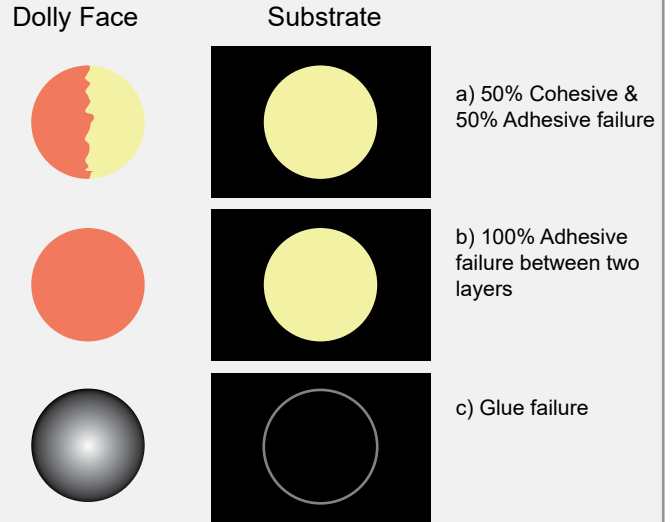

Cohesive Failure Layer ^d		Adhesive Failure Layers	
Code	Description	Code	Description
A	Substrate	A/B	Substrate & Layer 1
B	Layer 1	B/C	Layer 1 & Layer 2
C	Layer 2	C/D	Layer 2 & Layer 3
D	Layer 3	D/E	Layer 3 & Layer 4
E	Layer 4	E/F	Layer 4 & Layer 5
F	Layer 5	F/Y	Layer 5 & Glue
Y	Glue	Y/Z	Glue & Dolly

The data is saved in the batch and can be viewed at any time displayed as

##.## MPa^e **N% A M% A/B**, where;
##.## MPa^e = Pull Force in MPa or other measurement units (psi, Newtons or Nmm⁻²)
N% = Cohesive failure percentage^f
A = Cohesive failure layer
M% = Adhesion failure percentage^f
A/B = Intercoat adhesive failure layers

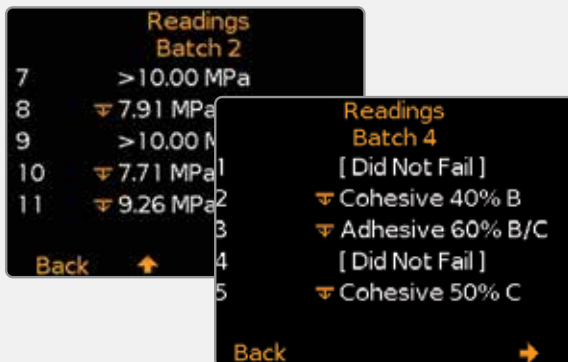

^d The number of layers can be user defined for each batch via Batch/New Batch/Number of Layers. This will affect the number of layers available for selection during attribute recording. The maximum number of layers available is five, excluding the substrate and glue.

^e Or equivalent units. ^f To the nearest 10%, in line with International Standards.

Automatic Pull-Off Adhesion Gauge

Elcometer 510

Create instant reports with ElcoMaster®

What you do with the collected data is just as important as taking the readings themselves.

ElcoMaster® is a fast, easy to use software solution for all your data management and quality assurance needs, preparing professional inspection reports at the click of a button.



Whether you are out in the field or on the factory floor, using the ElcoMaster® Mobile App users can;

- Store live readings directly on to a mobile device and save them into batches.
- View the pull rate graph in real-time for the duration of the test.
- Add attribute data to each individual batch reading.
- Add photographs of the dolly and test surface to each individual batch reading at the click of a button.
- Plot individual readings on to a location map, photograph or diagram.
- Inspection data can be transferred from mobile to PC for further analysis and reporting.
- Generate instant .pdf¹ report for submission.

Combine different inspection parameters (such as dry film thickness, surface profile, salt contamination, climate or adhesion) together with images, notes and other project specific information into customised reports.

Data transferred from the gauge to ElcoMaster® includes;

- Adhesion Measurements
- Date & Time
- Cohesive/Adhesive Failure Attributes
- Dolly size
- Pull rate graph
- Pull to Limit/Max
- Limit values
- Limit Hold Time
- Cutting Device
- Number of Layers
- Skirt Type/Support Ring Dimensions
- Batch Information & Statistics
- Calibration Information
- Calibration Verification Date/Time



¹ Available on iOS devices only

Elcometer 510

Automatic Pull-Off Adhesion Gauge

Product Features

 Standard
 Optional

	Model S	Model T
Repeatable & reproducible measurements	■	■
Easy to use menu structure; <i>in multiple languages</i>	■	■
Tough, impact, waterproof & dust resistant; <i>equivalent to IP64</i>	■	■
Bright LCD colour screen; <i>with ambient light sensor</i>	■	■
Scratch & solvent resistant display; <i>2.4" (6cm) TFT</i>	■	■
Calibration certificate	■	■
2 year gauge warranty*	■	■
Automatic rotating display; <i>0°, 180°</i>	■	■
Data output via USB (Live readings - and batch)	■	■
Data output via Bluetooth®		■
PC command; <i>start & stop gauge from a PC with live readings (USB only)</i>		■
Switchable Units (MPa, psi, N, Nmm ²)	■	■
On-Screen Statistics (η , \bar{x} , σ , <i>Hi, Lo, CV%, N>hi limit</i> †)	■	■
Pull Rate Indicator	■	■
Trend Graph	■	■
Pull Rate Graph (<i>Load v Time</i>)		■
Interchangeable Dolly Selection; <i>10, 14.2, 20 & 50mm</i>	■	■
User Selectable Pull Rates; (Model S & Model T Standard Mode)		
10mm: 1.00, 2.00, 3.00, 4.00, 5.00 MPa/s 125, 200, 400, 600, 725psi/s		
14.2mm: 0.4, 0.7, 1.4, 2.0, 2.5 MPa/s 60, 100, 200, 300, 360psi/s	■	■
20mm: 0.2, 0.3, 0.7, 1.0, 1.2 MPa/s 30, 50, 100, 150, 180psi/s		
50mm: 0.04, 0.08, 0.12, 0.16, 0.20 MPa/s 5, 8, 16, 24, 30psi/s		
User Selectable Pull Rates; (Model T Advanced Mode)		
10mm: 0.40 - 5.60 MPa/s 58 - 812psi/s in 0.1MPa / 1psi steps		
14.2mm: 0.20 - 2.80 MPa/s 29 - 403psi/s in 0.1MPa / 1psi steps		■
20mm: 0.10 - 1.40 MPa/s 15 - 203psi/s in 0.1MPa / 1psi steps		
50mm: 0.02 - 0.22 MPa/s 2 - 32psi/s in 0.01MPa / 0.1psi steps		
User Selectable Limit & Limit Hold Time		■
Gauge Memory; <i>maximum number of readings</i>	60	60,000*
Number of Batches (<i>Alpha Numeric - Model T</i>)	1	2,500
Attribute Modes to meet National & International Standards		■
Display Modes		
Readings, Selected Stats & Run Chart (last 20 readings)	■	■
Pull Rate Graphs		■
Batch Review		■
Power; <i>Battery (B), AC Mains Power (M)</i>	B	B, M
USB Cable & ElcoMaster® CD	■	■
Power Cable with Multi International Plug Adaptor (<i>UK, EU, US, AUS</i>)		■
Plastic Transit Case	■	■
Date & Time		■
In Field Adhesion Calibration Verification Mode	■	■

* The Elcometer 510 is extendable within 60 days from date of purchase, free of charge, to 2 years via www.elcometer.com

† Model T only.

* When 'Rate Graph' is enabled, the number of readings which can be stored depends on the graph resolution selected

Automatic Pull-Off Adhesion Gauge

Elcometer 510

Technical Specification

C

Part Number	Description				Certificate
F510-20S	Elcometer 510 Model S Automatic Adhesion Gauge; 20mm Kit				●
F510-20T	Elcometer 510 Model T Automatic Adhesion Gauge; 20mm Kit				●
F510-50S	Elcometer 510 Model S Automatic Adhesion Gauge; 50mm Concrete Kit				●
F510-50T	Elcometer 510 Model T Automatic Adhesion Gauge; 50mm Concrete Kit				●
Pressure Accuracy	±1% of full scale		Pull Rate Accuracy	±(2.5% + 0.3 seconds)	
Pressure Resolution	0.01MPa (1 psi)		Pull Rate Resolution	0.01MPa/s (1psi/s)	
Dolly Diameter	10mm (0.39")	14.2mm (0.56")	20mm (0.76")	50mm (1.96")	
Operating Range	8 - 100 MPa (1200 - 14400 psi)	4 - 50 MPa (600 - 7200 psi)	2 - 25 MPa (300 - 3600 psi)	0.3 - 4 MPa (50 - 580 psi)	
Pull Rate Range	0.4 - 5.6MPa/s (58 - 812psi/s)	0.2 - 2.8MPa/s (29 - 403psi/s)	0.1 - 1.4MPa/s (15 - 203psi/s)	0.02 - 0.22MPa/s (2 - 32psi/s)	
Gauge Dimensions	260 x 100 x 66mm (6.3 x 3.9 x 2.6")				
Actuator Height ¹	85mm (3.4")	85mm (3.4")	85mm (3.4")	110mm (4.3")	
Instrument Weight ¹	2.9kg (6.4lb)	2.9kg (6.4lb)	2.9kg (6.4lb)	3.1kg (8.3lb)	
Kit Weight	-	-	6.1kg (13.5lb)	7.3kg (16.1lb)	
Power Supply	8 x AA batteries (16 rechargeable batteries supplied complete with charger) or AC mains power (Model T only)				
Battery Life	~200 pulls per charge up to 25MPa (3600psi) at 1MPa/s (150psi/s), recharge time <5 hours				
Packing List: 20mm Kit	Elcometer 510 Adhesion Tester with 20mm dollies (x10), standard skirt for 20mm dollies, 20mm dolly cutter handle, 20mm dolly cutter, Araldite standard two part epoxy adhesive (2 x 15ml tubes), abrasive pad, shoulder harness, carry case, 16 x AA MiMH rechargeable batteries & charger (UK, EU, US, AUS), mains power supply (UK, EU, US, AUS) (Model T), ElcoMaster® CD & USB cable, calibration certificate and operating instructions.				
Packing List: 50mm Kit	Elcometer 510 Adhesion Tester with 50mm dollies (x6), standard skirt for 50mm dollies, 50mm dolly cutter arbor, 50mm dolly cutter, Araldite standard two part epoxy adhesive (2 x 15ml tubes), abrasive pad, shoulder harness, carry case, 16 x AA MiMH rechargeable batteries & charger (UK, EU, US, AUS), mains power supply (UK, EU, US, AUS) (Model T), ElcoMaster® CD & USB cable, calibration certificate and operating instructions.				

Accessories

Dolly Diameter	Pack of 10 [†]	Pack of 100	Standard Skirt	Thin Substrate Skirt	Cutter Handle/ Arbor	Dolly Cutter
10mm (0.39")	T5100010AL-10	T5100010AL-100	T9991420S	-	-	-
14.2mm (0.56")	T9990014AL-10	T9990014AL-100	T9991420S	T9990014T	T9991420H	T9990014CT
20mm (0.76")	T9990020AL-10	T9990020AL-100	T9991420S	T9990020T	T9991420H	T9990020CT
50mm (1.96")	T9990050AL-4	-	T9990050S	-	T9990050H	T9990050CT
50mm (1.96") Stainless Steel	T9990050SS-4	-	T9990050S	-	T9990050H	T9990050CT
Part Number	Description					
T99923797	Magnetic Anchor Clamp - holds actuator securely during tests on vertical surfaces					
T99912906	Araldite Standard Two Part Epoxy Adhesive, 2 x 15ml Tubes					
T99923147	Dolly Cleaning Heating Tongs - EUR 220V / UK 240V					
T99923103	Dolly Cleaning Heating Tongs - US 110V					

● Calibration Certificate supplied as standard.

¹ Including Actuator with Standard Skirt fitted.
[†] 50mm (2") dollies are supplied in packs of 4.

Elcometer 510

Automatic Pull-Off Adhesion Gauge

Pull-Off Adhesion Tests - Preventing Adhesive and Cohesive Failures**Preparing the surface and dolly**

1. Select an appropriate test area which is flat and has sufficient area to attach the adhesion gauge.
2. Abrade the dolly and surface, clean both to remove any dust - minimising the risk of an 'adhesive' failure.

Fixing the dolly

3. Mix the adhesive correctly and apply a uniform adhesive film over the entire dolly face.
4. Test Standards require that the dolly is pulled off perpendicularly to the test surface. The dolly must therefore be adhered on to a prepared flat test surface (see images below). Apply an even pressure to the dolly to ensure that the dolly face is parallel to the test surface.
5. Remove any excess adhesive from around the dolly and allow to fully cure. Tape maybe required when applying dollies to vertical surfaces during the cure process.
6. If required, once the dolly has fully cured, score the coating around the dolly using the dolly cutter provided.
7. Attach the gauge actuator to the dolly and begin test.

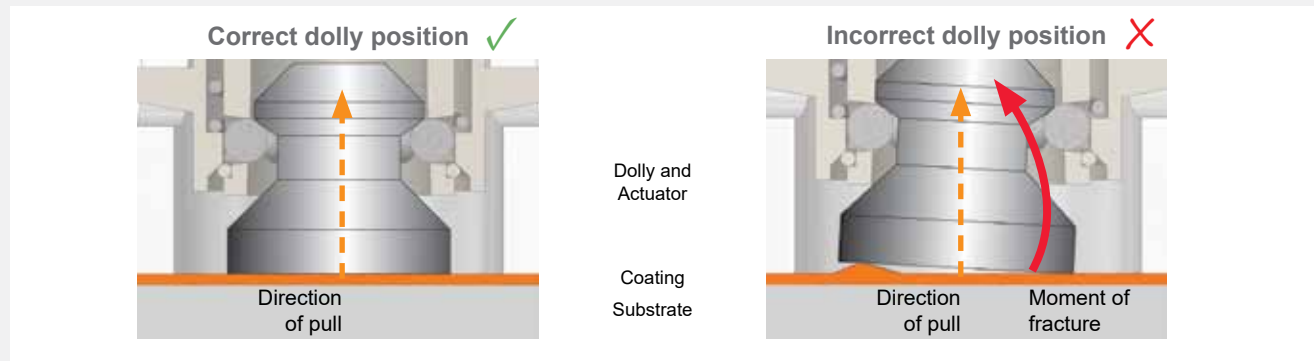
**Assessment of the Adhesion Test**

For a valid pull test the coating must cover at least 50% of the area of the dolly face. If the glue fails and no coating is present on the dolly, or it covers less than 50% of the dolly face area, the pull-test is invalid and should be repeated.

When the coating has failed within the layer leaving the same coating on both the dolly and the test panel it is known as a '*cohesive failure*'.

'*Adhesive failures*' occur when either the coating has failed at the interface with another coating (leaving a coating on the dolly and another coating on the substrate), or when the coating has failed at the substrate (leaving the coating on the dolly and the substrate bare).

NOTE: If the glue fails at a value above the specification then it can be reported that the adhesion exceeded the specification for this individual test.

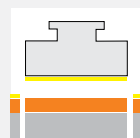
Coating Adhesion Testing on Concrete

Adhesive Failure

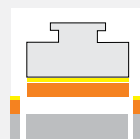

Coating Failure

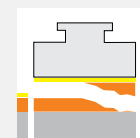

Partial Coating Failure

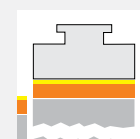

Concrete Failure

Adhesion Verification Unit (AVU)

The Elcometer AVU has been designed to provide users with the means to confirm the accuracy of their pull-off adhesion gauge.

Due to its robust design the Elcometer AVU is suitable for use on site or in the laboratory and allows users to verify or self-certify their pull-off adhesion gauges.

A range of dolly adaptors are available for testing the Elcometer 106, Elcometer 506 and Elcometer 510 adhesion gauges. Adaptors are also available for testing other manufacturers' gauges.

Attach the appropriate dolly adaptor to the AVU, connect your adhesion gauge, apply load and compare the adhesion tester value to the reading on the AVU Display.

Features include:

- Max hold and live reading display
- MPa / psi switchable units
- Backlit display
- Automatic switch off

The Elcometer AVU is supplied with either a test certificate or full calibration certificate, suitable for self-certification.

Elcometer AVU



Technical Specification



Part Number	Description	Certificate
T99923924	Elcometer AVU Adhesion Verification Unit	●
T99923924C	Elcometer AVU Adhesion Verification Unit - Certified	○
Range	0-30MPa (0-4000psi)	
Resolution	0.01MPa (1psi)	
Accuracy	±0.1MPa (±14.5psi)	
Battery Type	2 x AA batteries	
Gauge Dimensions	165 x 155 x 105mm (6.5 x 6.1 x 4.1")	
Gauge Weight	3kg (6.6lbs)	
Packing List	Elcometer AVU, Elcometer 506/510 20mm (0.76") dolly adaptor, test or calibration certificate (as appropriate), 2 x AA batteries, carry case and operating instructions	

Accessories

T99923935	Elcometer 506 & 510 Dolly Adaptor; 20 & 14.2mm (0.76 & 0.56") Skirts
T99923936	Elcometer 506 & 510 Dolly Adaptor; 50mm (2.0") Skirt
T99923937	Elcometer 106 Dolly Adaptor; Scales 1 to 4
T99923938	Elcometer 106 Dolly Adaptor; Scale 6
T99923939	AT-M & AT-A Adhesion Gauge Dolly Adaptor
T99923986	PAT Adhesion Gauge Dolly Adaptor

● Test Certificate supplied as standard.

○ Calibration Certificate supplied as standard.



elcometer[®]
www.elcometer.com

elcometer.be • elcometer.fr • elcometer.de • elcometer.nl
elcometer.jp • elcometer.ae • elcometer.com.sg

Elcometer 510 Model T: Made for iPhone 6 Plus, iPhone 6, iPhone 5s, iPhone 5c, iPhone 5, iPhone 4s, iPhone 4, iPad Air 2, iPad mini 3, iPad Air, iPad mini 2, iPad (3rd and 4th generation), iPad mini, iPad 2, and iPod touch (4th and 5th generation). "Made for iPod," "Made for iPhone," and "Made for iPad" mean that an electronic accessory has been designed to connect specifically to iPod, iPhone, or iPad, respectively, and has been certified by the developer to meet Apple performance standards. Apple is not responsible for the operation of this device or its compliance with safety and regulatory standards. Please note that the use of this accessory with iPod, iPhone, or iPad may affect wireless performance.

iPad, iPhone, and iPod touch are trademarks of Apple Inc., registered in the U.S. and other countries. App Store is a trademark of Apple Inc., registered in the U.S. and other countries. Suitable for mobile devices running Android software version 2.1 and upwards. Elcometer and ElcoMaster[™] are registered trademarks of Elcometer Limited. All other trademarks acknowledged.

© Elcometer Limited, 2016. All rights reserved. No part of this document may be reproduced, transmitted, stored (in a retrieval system or otherwise), or translated into any language, in any form, or by any means, without the prior written permission of Elcometer Limited.

Due to our policy of continuous improvement, Elcometer Limited reserves the right to change specifications without notice. All gauges come with a 1 year warranty as standard, the Elcometer 510 is extendable within 60 days from date of purchase, free of charge, to 2 years via www.elcometer.com

ENGLAND

Elcometer Limited
Manchester M43 6BU
Tel: +44 (0)161 371 6000
Fax: +44 (0)161 371 6010
sales@elcometer.com
www.elcometer.com

BELGIUM

Elcometer SA
Tel: +32 (0)4 379 96 10
Fax: +32 (0)4 374 06 03
be_info@elcometer.com
www.elcometer.be

FRANCE

Elcometer Sarl
Tel: +33 (0)2 38 86 33 44
Fax: +33 (0)2 38 91 37 66
fr_info@elcometer.com
www.elcometer.fr

GERMANY

Elcometer Instruments GmbH
Tel: +49(0)7361 52806 0
Fax: +49(0)7361 52806 77
de_info@elcometer.com
www.elcometer.de

THE NETHERLANDS

Elcometer B.V.
Tel: +31 (0)30 259 1818
Fax: +31 (0)30 210 6666
nl_info@elcometer.com
www.elcometer.nl

JAPAN

Elcometer KK
Tel: +81-(0)3-6869-0770
Fax: +81-(0)3-6433-1220
jp_info@elcometer.com
www.elcometer.jp

REPUBLIC OF SINGAPORE

Elcometer (Asia) Pte Ltd
Tel: +65 6462 2822
Fax: +65 6462 2860
asia@elcometer.com
www.elcometer.com.sg

UNITED ARAB EMIRATES

EL Inspection & Blasting
Equipment LLC
Tel: +971 4 295 0191
Fax: +971 4 295 0192
uae_sales@elcometer.com
www.elcometer.ae

USA

MICHIGAN
Elcometer Inc
Tel: +1 248 650 0500
Toll Free: 800 521 0635
Fax: +1 248 650 0501
inc@elcometer.com
www.elcometer.com

TEXAS

Elcometer of Houston
Tel: +1 713 450 0631
Toll Free: 800 521 0635
Fax: +1 713 450 0632
inc@elcometer.com
www.elcometer.com