

ACCESSORIES COUPLING AND FITTINGS

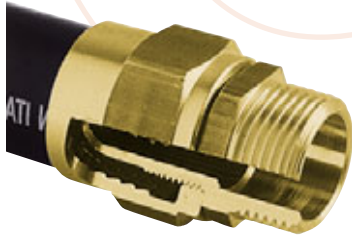

PRODUCTS' RANGE

Union
re-usable coupling



| Code | Description | Inlet/Outlet | | | Key 1 | Key 2 |
|---------------|-------------|--------------|------|------|-------|-------|
| | | A BSP | B mm | C mm | | |
| Swivel | | | | | | |
| 000890000 | Union 34.27 | 3/4" | 19 | 27 | 25 | 38 |
| 000891000 | Union 1.27 | 1" | 19 | 27 | 94 | 31 |
| 000892000 | Union 1.35 | 1" | 25 | 35 | 38 | 38 |
| 000893000 | Union 34.32 | 3/4" | 19 | 32 | 34 | 31 |
| 000894000 | Union 1.32 | 1" | 19 | 32 | 34 | 38 |
| 000895000 | Union 1.38 | 1" | 25 | 38 | 94 | 38 |

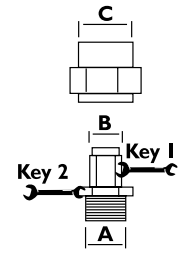

1



2



3



4

HQC
Hose Quick Coupling

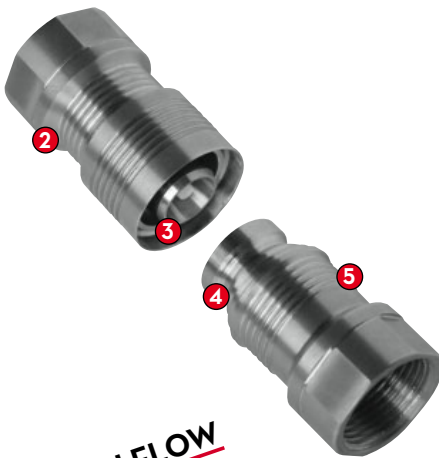
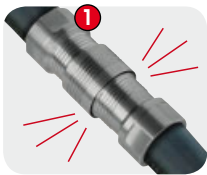

HIGH FLOW

EN. Hose quick coupling PIUSI has developed a new quick coupling that is suitable for use with diesel. In the past, quick couplings for use with diesel derived from quick couplings that were intended for use with oil, where the bores on the interior were too small for the diesel supply flow. With this quick coupling, this issue does not come into play. Here the bore has been designed to minimise resistance in the presence of high flow rates during the supply of the diesel.

1 - Fully closed position
2 - Open position
3 - Male coupling
4 - Female coupling
5 - Embossed profile: improves grip for coupling/uncoupling.

ES. Conexión rápida para tubo PIUSI ha desarrollado una nueva conexión rápida apta para el uso con gasóleo. En el pasado, las conexiones rápidas para gasóleo derivaban de conexiones rápidas para aceite y los orificios internos no eran lo suficientemente grandes para el caudal del suministro del gasóleo. Hoy, el orificio de esta conexión rápida ha sido diseñado para reducir al mínimo la resistencia en presencia de altos caudales durante el suministro del gasóleo.

1 - Posición todo cerrado
2 - Posición abierta
3 - Conexión macho
4 - Conexión hembra
5 - Perfil en relieve: mejora el agarre en fase de enganchar/desenganchar.

PT. Engate rápido para tubo A PIUSI desenvolveu um novo engate rápido apropriado para utilizar com gasóleo. Antigamente os engates rápidos para gasóleo derivavam de engates rápidos para óleo e os furos interiores não eram suficientemente grandes para a vazão do abastecimento do gasóleo. Agora o furo deste engate rápido foi projectado para diminuir ao mínimo a resistência com as vazões grandes que há durante o abastecimento de gasóleo.

1 - Posição inteiramente fechado
2 - Posição aberto
3 - Engate macho
4 - Engate fêmea
5 - Perfil em relevo: mais fácil de segurar na fase de enganchar/desenganchar.

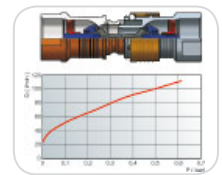

EN. Moulded internal profile: reduces pressure loss.

ES. Perfil interno conformado: reduce las pérdidas de carga

PT. Perfil interior moldado: diminui as perdas de carga.

PRODUCTS' RANGE

| Code | Description | Weight | Pack. | Packaging |
|------------|----------------------------|--------|----------|-----------|
| | | Kg | pcs. no. | mm |
| HQC | | | | |
| F00636000 | HQC Hose Quick Coupling 1" | 0,46 | 1 | 80x80x75 |

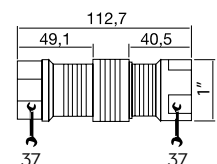

PRODUCTS' RANGE

Elbows



| Code | Description | A | B | Q.ty | Key |
|---------------|-------------|------------|------------|------|-----|
| Elbows | | | | | |
| F07806000 | | F 3/4" BSP | F 3/4" BSP | - | - |
| F07805000 | | M 3/4" BSP | F 3/4" BSP | - | - |
| F08609000 | | F 1" BSP | F 1" BSP | - | - |
| F07988000 | | M 1" BSP | F 1" BSP | - | - |
| F14279000 | Inox | M 1" BSP | F 1" BSP | - | - |

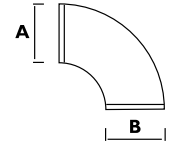

Hose tails



Inox Version

| | | | | | |
|-------------------|------|------------|-------|----|----|
| Hose tails | | | | | |
| F0826700A | | 1/2" BSP | 19 mm | 1 | 27 |
| F0643700A | | 3/4" BSP | 19 mm | 20 | 32 |
| F0776800B | | 3/4" BSP | 25 mm | 20 | 32 |
| F0775700A | | 1" BSP | 19 mm | 20 | 37 |
| F0776400A | | 1" BSP | 25 mm | 20 | 37 |
| F14122000 | Inox | M 1" BSP | 19 mm | 1 | 37 |
| F14123000 | Inox | F 3/4" BSP | 19 mm | 1 | 37 |

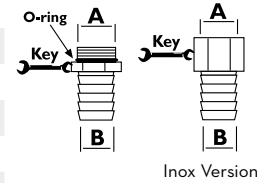

Rotating hose tails - Inox



| | | | | | |
|----------------------------------|------|----------|-------|---|----|
| Rotating hose tail - Inox | | | | | |
| F14132000 | Inox | 3/4" BSP | 19 mm | - | 27 |

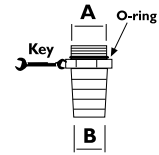

Sleeve



| | | | | | |
|---------------|--|-------|-------|---|----|
| Sleeve | | | | | |
| F08137000 | | 28 mm | 20 mm | - | 30 |
| F08138000 | | 36 mm | 28 mm | - | 35 |

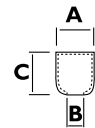

Sleeve



| | | | | | |
|---------------|--|------------|------------|---|----|
| Sleeve | | | | | |
| F07766000 | | M 3/4" BSP | M 3/4" BSP | - | 27 |
| F07765000 | | M 1" BSP | M 1" BSP | - | 34 |

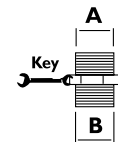

Reducing sockets



| | | | | | |
|-------------------------|--|------------|--------------|---|----|
| Reducing sockets | | | | | |
| F07441000 | | F 1/2" BSP | M 3/4" BSP | - | 30 |
| F07762000 | | M 3/4" BSP | M 1" BSP | - | 34 |
| F08913000 | | M 1" BSP | M 1 1/2" BSP | - | 50 |
| F07760000 | | F 3/4" BSP | M 1" BSP | - | 35 |
| F07889000 | | F 1" BSP | M 3/4" BSP | - | 34 |
| 008891000 | | F 1" BSP | M 2" BSP | - | 60 |

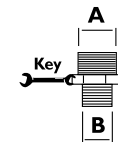

Elbow rotating connector

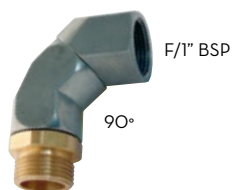

M/1" BSP

Code **F14567000**

Sealant paste

| Code | Description | | Q.ty |
|-----------|---------------------|---------|------|
| F08173000 | Light removable | g. 130 | 1 |
| F10767000 | Medium removable | ml. 250 | 1 |
| F12278000 | Heavy non removable | ml. 250 | 1 |

