

Texture Gun & Hopper

311776B

- For Water-Based Materials and Indoor Use Only -

Models 245924 Series D

*125 psi (8.75 bar, 0.875 MPa) Maximum Working Air Pressure
70 psi (4.9 bar, 0.49 MPa) Maximum Working Fluid Pressure*



Important Safety Instructions

Read all warnings and instructions in this manual.
Save these instructions.

Related Manuals



311777

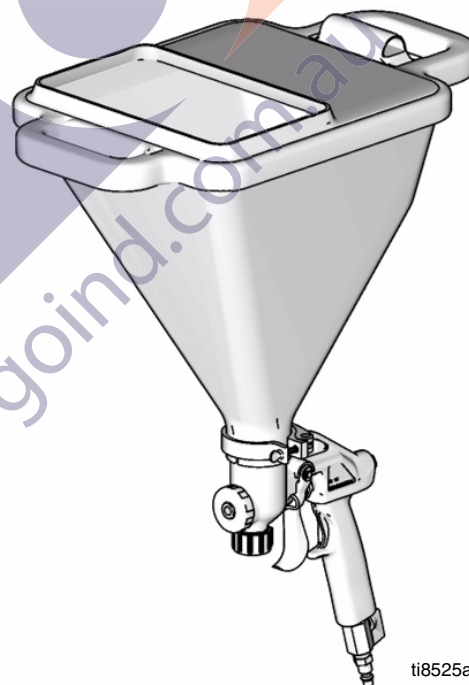









ti8525a

PROVEN QUALITY. LEADING TECHNOLOGY.

Warnings

The following are general warnings related to the setup, use, grounding, maintenance and repair of this equipment. Additional, more specific warnings may be found throughout the body of this manual where applicable. Symbols appearing in the body of the manual refer to these general warnings. When these symbols appear through the manual, refer back to these pages for a description of the specific hazard.

	Warnings
	<p>Equipment Misuse Hazard Equipment misuse can cause equipment to rupture, malfunction, or start unexpectedly and cause serious injury.</p> <ul style="list-style-type: none"> • Before operating this equipment, read all manuals, tags, and labels including material labels and instructions. • Do not expose system to rain. Always store system indoors. • Do not alter or modify equipment. • Do not spray cementitious materials. • Do not exceed maximum working pressure of lowest rated component in your system. • Check equipment daily. Repair or replace worn or damaged parts immediately. • To reduce risk of serious injury, including electric shock and splashing fluid in eyes, follow Pressure Relief Procedure, page 3 before servicing the unit. • Do not use hoses to pull equipment. • Route hoses away from traffic areas, sharp edges, moving parts and hot surfaces. Do not expose Graco hoses to temperatures above 130° F (55° C) or below -35° F (-37° C). • Store hazardous fluid in an approved container. Dispose of hazardous fluid according to all local, state and national guidelines. • Never directly inhale compressed air. Compressed air may contain toxic vapors.
	<p>Electric Shock Hazard To reduce the risk of electric shock:</p> <ul style="list-style-type: none"> • Be sure sprayer is adequately grounded through electrical outlet. • Use only 3-wire, extension cords. • Make sure ground prongs are intact on sprayer and extension cords. • Do not operate with cover removed. • Turn off sprayer. Follow Pressure Relief Procedure, page 3, and unplug unit, before removing any parts.

	Warnings
 	Pressurized Equipment Hazard Fluid from gun, leaks or ruptured components can splash in the eyes or on skin and cause serious injury. <ul style="list-style-type: none"> • Follow Pressure Relief Procedure, page 3 when you stop spraying and before cleaning, checking or servicing. • Do not point spray gun at anyone; put hand, fingers or rag over nozzle, or stop or deflect leaks with your hand, body, glove, or rag. • Wear protective clothing, gloves, and eyewear.
	Personal Protective Equipment You must wear appropriate protective equipment when operating, servicing, or when in the operating area of the equipment to help protect you from serious injury, including eye injury, inhalation of toxic fumes, burns, and hearing loss. This equipment includes but is not limited to: <ul style="list-style-type: none"> • Protective eyewear • Clothing and respirator as recommended by the fluid and solvent manufacturer • Gloves • Hearing Protection
	Cleaning Solvent Hazard with Plastic Parts Use only compatible water-based solvents to clean plastic structural or pressure-containing parts. Many solvents can degrade plastic parts to the point where they could fail. Such failure could cause serious injury or property damage. See Technical Data on page of this instruction manual and in all other equipment manuals. Read fluid and solvent manufacturer's warnings.
	Sprayer Warnings For sprayer operation and warning information refer to your sprayer or compressor operation manual.



Pressure Relief Procedure

To reduce the risk of serious bodily injury, including electric shock and splashing fluid in eyes, follow this procedure whenever you stop spraying:

1. Shut OFF air source.
2. Turn main Pump Power OFF.
3. Disconnect power source from both air and material product.
4. Turn gun air valve ON.
5. Point gun into waste bucket and open trigger to relieve pressure.



Grounding

To reduce risk of electrical shock, proper electrical grounding is essential. See your sprayer or compressor instruction manual and consult your local electrical codes for detailed grounding instructions.

Component Identification

Model 245924

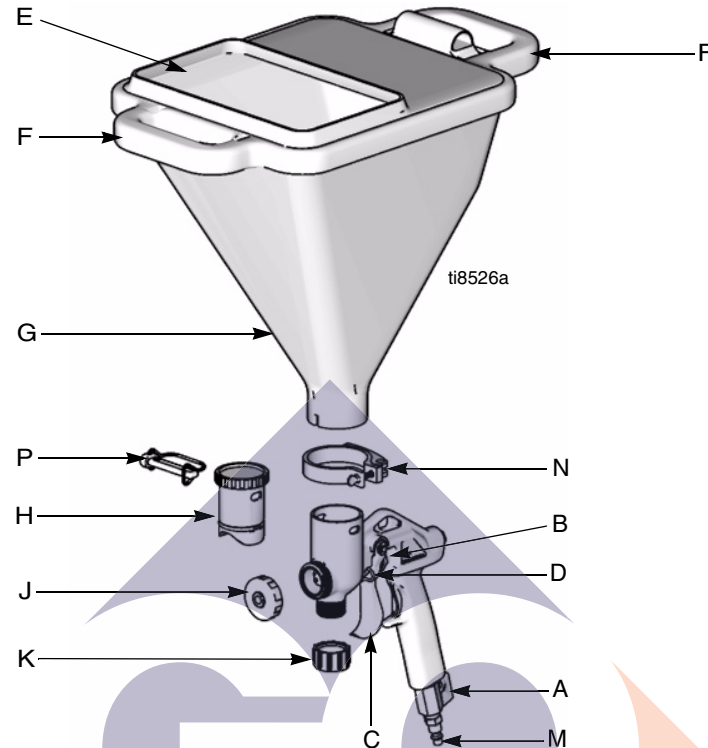

Identifier	Component	Description
A	Air Valve	Adjusts air to material mix ratio.
B	Flow Adjustment Nut	Sets needle position.
C	Trigger	Engages material flow/shuts off material flow.
D	Trigger Lock	Holds trigger open to assist operator during long jobs.
E	Material Fill Opening	Where mixed material is loaded into hopper. For overhead applications and high walls, position hopper on gun with material fill opening facing toward nozzle (J) (front) of gun. For all other applications, material fill opening should face toward the air valve (A) (back) of gun.
F	Handles	Provided for operator comfort and relieve operator fatigue during long jobs.
G	Hopper	Holds material.
H	Gun Plug	Must be in place when material hose is used with texture pump system. To use hopper, remove plug and install hopper as described on page 5.
J	Nozzle	Different sizes available for use with different applications, See Nozzle Selection chart, page 7. #2 provided with 253898.
K	Hose Plug	Must be installed when hopper is used. See Graco RTX manual for installation and operating instructions for this feature.
M	Air Fitting	Quick Disconnect used to attach air hose to gun.
N	Clamp	Secures hopper on gun.
P	Gun Plug Clip	Secures gun plug to gun. WARNING: Must be installed prior to pressurizing system with RTX material feed system.

Basic Operation for Hopper Gun Setup

Hopper Installation

1. The Hose Plug must be securely fastened to bottom of gun when using the Hopper. Gun Plug must be removed from top of gun.

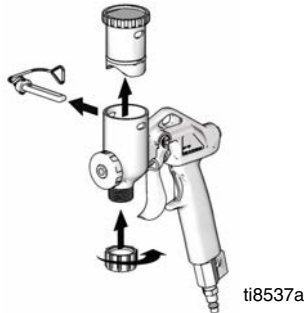

4. Fasten clamp.
5. Connect air hose to gun.

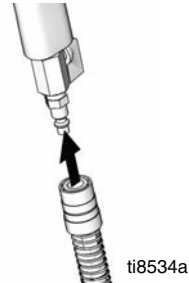

6. Install spray nozzle, page 7.

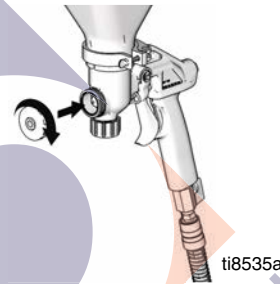

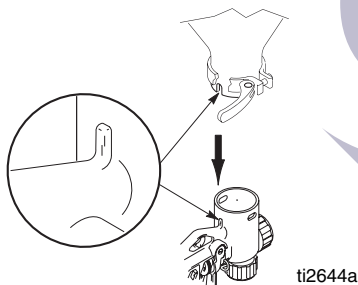

 It is easier to remove plug if gun is triggered.

2. Align notched opening in base of hopper to raised notch on hopper port of gun body.

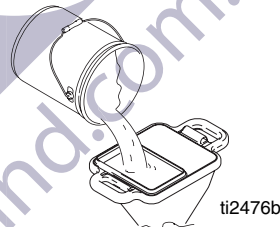

7. Fill hopper with texture mix.



 For overhead applications and high walls, position the hopper on the gun with the material fill opening facing toward the nozzle (front) of the gun. For all other applications, material fill opening should face the air valve (back) of the gun.

3. Push hopper down, over hopper port as far as it will go.

8. Open air valve.
9. Turn compressor ON. Adjust air valve for desired texture.

Mixing Material



Correct material mixture is essential to achieve the desired finish.

Mix the material in a separate container before pouring it into hopper.

Dry Mix - 40 lb (18 kg) bag.



For best results do not use partial bags of material.

1. Slowly add one 40 lb. (18 kg) bag of texture material to 5-6 gallons (18.9-22.7 liters) of clean water as instructed on the bag instructions.



2. Agitate to mix, using a half-inch, variable speed drill with mixing paddle, to a smooth, lump-free consistency.



3. Allow ceiling texture to set for at least 15 minutes. Then remix prior to use.

Premix

1. Slowly add approximately 2 to 4 qts (1.9 to 3.8 liters) of water to a 5 gallon (18.9 liter) bucket of premix.



2. Agitate to mix, using a half-inch, variable speed drill with a mixing paddle, to a smooth, lump-free consistency.

Spray Techniques

Recommended Nozzle Selection Chart

Application	Nozzle Size ²	Air Volume ¹
Simulated Acoustic	6 mm, white (<i>fine to medium</i>) 8 mm, gray (<i>coarse</i>)	medium to high
Orange peel	4 mm, beige 6 mm, white	medium to high
Splatter coat	6 mm, white 8 mm, gray	low to medium
Knockdown	8 mm, gray 12 mm, black	low

¹Control air volume with gun air valve.

²For more material volume try a larger nozzle.

Adjusting the System

Sufficient fluid output (volume and pressure) and good atomization is a balance of atomizing air, material thickness/material flow and nozzle selection. Achieving the correct balance for your application requires experimentation to achieve desired results. Keep in mind these important points when adjusting gun:

1. Select proper nozzle for your application. See Nozzle Selection Chart. Remember, the larger the nozzle, the heavier the pattern.
2. Start with gun air flow valve completely open. If needed, slowly close gun air flow until you get a good spray pattern.

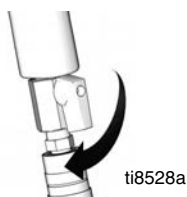

3. Adjust air flow adjustment nut and air valve to achieve uniform, round spray pattern. It may be necessary to change spray nozzles to achieve the desired spray pattern.

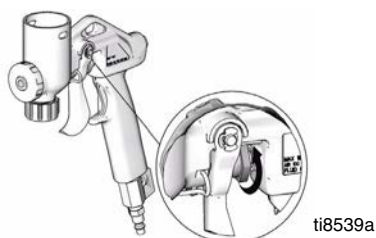

- When adjusting flow nut, release trigger, then adjust.
- If adjusting while triggered, needle will turn but provide no adjustment.
- If nut will not turn, check to see if it is either set to maximum adjustment or there is material on threads. Clean threads as needed.
- Test spray pattern on cardboard. Hold gun 18 to 24 in. (45.7 to 60.9 cm) from surface. Using a circular motion, overlap each stroke.

To Get Less Material

Try one or a combination of these methods:

- Open air valve
- Turn gun flow adjustment nut to decrease flow, counter-clockwise
- Use smaller nozzle

To Get More Material

Try any one or a combination of these methods:

- Close air valve
- Turn gun flow adjustment nut to increase flow, clockwise
- Use thinner material mixture
- Use a larger nozzle

For Continuous Spraying

Use trigger lock to hold trigger open and reduce fatigue.

Check Material Consistency Periodically

Check and thin material as needed to maintain proper consistency. The material may thicken as it sits and slow down production. Agitate periodically.

Cleanup

Once you have finished spraying, follow these steps to clean your gun and hopper.

1. Shut off compressor.
2. Disconnect air line from gun.

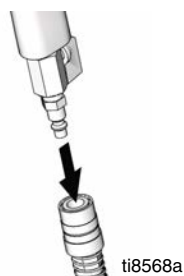

3. Drain remaining material into a bucket until most of the texture material is out of hopper.
4. Fill hopper with clean water. Remove nozzle from gun and allow water to flow through and out of gun.
5. Flush until gun is clean.
6. Remove hopper from gun and finish cleaning all components. A soft brush may be used to help loosen any dried on material from surface.
7. Connect air line to gun.

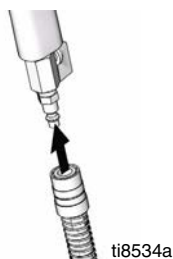

8. Turn on compressor.
9. Open gun air valve, forcing air through tip to clear out any remaining material.



10. Disconnect compressor.



Be sure to keep air passages in needle clean and free of material.

To improve working condition for future use, after cleaning, apply a few drops of light oil to:

- Air hose quick disconnect
- Material hose connections
- Flow adjustment on gun

goind.com.au

Troubleshooting

Problem	Cause	Solution
Material will not flow from hopper	<ul style="list-style-type: none"> • Material too thick • Not enough air • Gun adjustment set too low • Nozzle too small • Gun is plugged • Not enough material in hopper 	<ul style="list-style-type: none"> • Thin material • Open gun air valve more • Increase trigger travel • Increase nozzle size • Clean gun • Add material
Pattern too fine.	<ul style="list-style-type: none"> • Material too thin • Air pressure too high • Gun needle travels too low • Nozzle too small 	<ul style="list-style-type: none"> • Thicken • Close gun air valve partially • Increase • Replace nozzle with larger size
Pattern too course.	<ul style="list-style-type: none"> • Material too thick • Air pressure too low • Nozzle to large 	<ul style="list-style-type: none"> • Thin material • Open gun air valve more • Replace nozzle with smaller size
Gun will not shut off	<ul style="list-style-type: none"> • Worn nozzle or needle • Nozzle not on all the way • Debris in needle passage 	<ul style="list-style-type: none"> • Relieve Pressure, page 3 and replace worn parts • Tighten completely • Relieve Pressure, page 3 and clean
Fluid leaking at Flow Adjustment Nut	<ul style="list-style-type: none"> • Damaged seal 	<ul style="list-style-type: none"> • Relieve Pressure, page 3 and replace seal
Fluid leaking out of either plug	<ul style="list-style-type: none"> • Missing or damaged o-rings • Gun damaged 	<ul style="list-style-type: none"> • Relieve Pressure, page 3 and replace o-ring • Replace gun
Needle adjustment won't adjust	<ul style="list-style-type: none"> • Dirty threads • Nozzle not on gun • Needle triggered 	<ul style="list-style-type: none"> • Clean threads • Put nozzle on gun • Adjust when trigger not pulled
Material leaking out around gun/hopper connection	<ul style="list-style-type: none"> • Clamp not tight • Damaged gun/hopper • Debris between gun/hopper 	<ul style="list-style-type: none"> • Tighten • Check for damage and replace if needed • Remove hopper from gun, clean, and replace hopper if needed

Graco Standard Warranty

Graco warrants all equipment referenced in this document which is manufactured by Graco and bearing its name to be free from defects in material and workmanship on the date of sale to the original purchaser for use. With the exception of any special, extended, or limited warranty published by Graco, Graco will, for a period of twelve months from the date of sale, repair or replace any part of the equipment determined by Graco to be defective. This warranty applies only when the equipment is installed, operated and maintained in accordance with Graco's written recommendations.

This warranty does not cover, and Graco shall not be liable for general wear and tear, or any malfunction, damage or wear caused by faulty installation, misapplication, abrasion, corrosion, inadequate or improper maintenance, negligence, accident, tampering, or substitution of non-Graco component parts. Nor shall Graco be liable for malfunction, damage or wear caused by the incompatibility of Graco equipment with structures, accessories, equipment or materials not supplied by Graco, or the improper design, manufacture, installation, operation or maintenance of structures, accessories, equipment or materials not supplied by Graco.

This warranty is conditioned upon the prepaid return of the equipment claimed to be defective to an authorized Graco distributor for verification of the claimed defect. If the claimed defect is verified, Graco will repair or replace free of charge any defective parts. The equipment will be returned to the original purchaser transportation prepaid. If inspection of the equipment does not disclose any defect in material or workmanship, repairs will be made at a reasonable charge, which charges may include the costs of parts, labor, and transportation.

THIS WARRANTY IS EXCLUSIVE, AND IS IN LIEU OF ANY OTHER WARRANTIES, EXPRESS OR IMPLIED, INCLUDING BUT NOT LIMITED TO WARRANTY OF MERCHANTABILITY OR WARRANTY OF FITNESS FOR A PARTICULAR PURPOSE.

Graco's sole obligation and buyer's sole remedy for any breach of warranty shall be as set forth above. The buyer agrees that no other remedy (including, but not limited to, incidental or consequential damages for lost profits, lost sales, injury to person or property, or any other incidental or consequential loss) shall be available. Any action for breach of warranty must be brought within two (2) years of the date of sale.

GRACO MAKES NO WARRANTY, AND DISCLAIMS ALL IMPLIED WARRANTIES OF MERCHANTABILITY AND FITNESS FOR A PARTICULAR PURPOSE, IN CONNECTION WITH ACCESSORIES, EQUIPMENT, MATERIALS OR COMPONENTS SOLD BUT NOT MANUFACTURED BY GRACO. These items sold, but not manufactured by Graco (such as electric motors, switches, hose, etc.), are subject to the warranty, if any, of their manufacturer. Graco will provide purchaser with reasonable assistance in making any claim for breach of these warranties.

In no event will Graco be liable for indirect, incidental, special or consequential damages resulting from Graco supplying equipment hereunder, or the furnishing, performance, or use of any products or other goods sold hereto, whether due to a breach of contract, breach of warranty, the negligence of Graco, or otherwise.

legales en que se incurra, o bien se instituyan en cumplimiento con el presente documento o en relación directa o indirecta con el mismo, sean redactados en inglés.

ADDITIONAL WARRANTY COVERAGE

Graco does provide extended warranty and wear warranty for products described in the "Graco Contractor Equipment Warranty Program".

TO PLACE AN ORDER OR FOR SERVICE, contact your Graco distributor, or call 1-800-690-2894 to identify the nearest distributor.

All written and visual data contained in this document reflects the latest product information available at the time of publication. Graco reserves the right to make changes at any time without notice.

This manual contains English: MM 311776

Sales Office: Minneapolis

International Offices: Belgium, Korea, China, Japan

PRINTED IN USA 2007