



LineLazer™ V 3900, 5900 Airless Line Stripers Standard Series and High Production (HP) Auto Series

3A3388H
EN

For the application of line striping materials.

For professional use only.

For outdoor use only.

Not for use in explosive atmospheres or hazardous locations.

Maximum Operating Pressure: 3300 psi (22.8 MPa, 228 bar)



Important Safety Instructions

Read all warnings and instructions in this manual and in related manuals.

Be familiar with the controls and the proper usage of the equipment.

Save these instructions.

Related Manuals:	
3A3389	Parts
311254	Gun
309277	Pump
3A3428	Auto-Layout Applications Methods

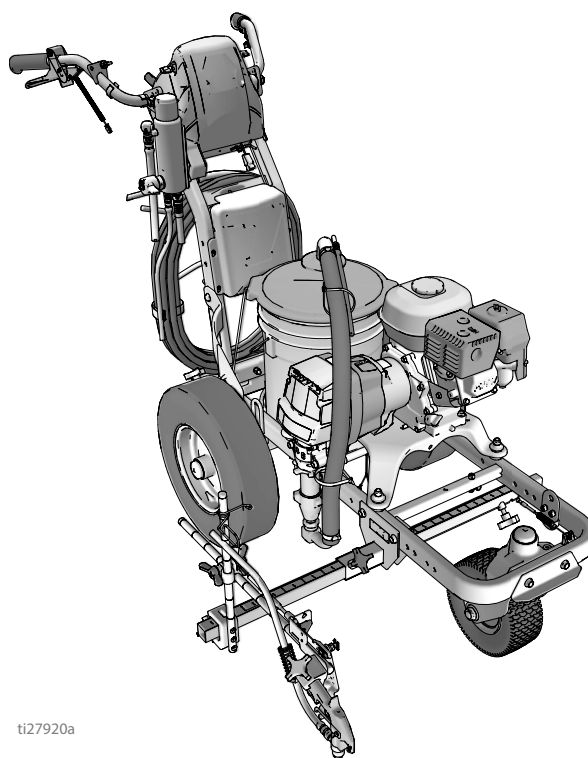

ti27920a

*Use only genuine Graco replacement parts.
The use of non-Graco replacement parts may void warranty.*

Contents

Models	3	HP Auto Series	33
Warnings	5	LineLazer V LiveLook Display	34
Important Laser Information for Units with Laser Option	8	HP Auto Series	34
Tip Selection	9	Initial Setup (HP Auto Series)	35
Component Identification (LLV 3900/5900)	10	Striping Mode (HP Auto Series)	37
Grounding Procedure (For Flammable Flushing Fluids Only)	11	Measure Mode (HP Auto Series)	38
Pressure Relief Procedure	11	Layout Mode	39
Setup/Startup	12	Stall Calculator	40
SwitchTip and Guard Assembly	14	Angle Calculator	41
Gun Placement	15	Setup/Information	43
Install Guns	15	Settings	44
Position Gun	15	Information	45
Select Guns (Standard Series)	15	Data Logging	47
Select Auto Guns (HP Auto Series)	16	Maintenance	48
Gun Positions Chart	17	LineLazer V 3900, 5900	48
Gun Arm Mounts	18	Recycling and Disposal	49
Change Gun Position (Front and Back)	18	Rechargeable Battery Disposal	49
Change Gun Position (Left and Right)	18	End of Product Life	49
Installation	19	Troubleshooting	50
Trigger Sensor Adjustment	19	Fluid Pump Runs Constantly	55
Gun Cable Adjustment	20	Pinion Assembly/Clutch Armature/Clamp	56
Straight Line Adjustment	21	Pinion Assembly/Clutch Armature Removal	56
Handle Bar Adjustment	21	Installation	57
Dot Laser (if applicable)	22	Clamp Removal	57
Cleanup	23	Clamp Installation	57
Standard Series	24	Wiring Diagram (Standard Series - China only) ..	58
LineLazer V LiveLook Display	25	Wiring Diagram (HP Auto Series - China only) ..	59
Standard Series	25	Wiring Diagram (Standard Series)	60
Initial Setup (Standard Series)	26	Wiring Diagram (HP Auto Series)	61
Striping Mode (Standard Series)	28	World Symbol Key	62
Measure Mode (Standard Series)	29	Technical Specifications	63
Setup/Information	30	California Proposition 65	68
Settings	31	Graco Standard Warranty	69
Information	32		

Models

LineLazer V 3900						
Model:	Series	Standard 1 Manual Gun	Standard 2 Manual Guns	HP Auto 1 Auto Gun	HP Auto 1 Auto Gun 1 Manual Gun	HP Auto 2 Auto Guns
17H449	B	✓ CE				
25P330	A	✓ CE				
17H450	B		✓ CE			
17K577	B			✓ CE		
25P332	A			✓ CE		
17H451	B			✓ with laser		
17K638	B				✓ CE	
17H452	B				✓ with laser	
17K579	B					✓ CE
25P333	A					✓ CE
17H453	B					✓ with laser

* All auto guns can be actuated manually.

Models











LineLazer V 5900						
Model:	Series:	Standard 1 Manual Gun	Standard 2 Manual Guns	HP Auto 1 Auto Gun	HP Auto 1 Auto Gun 1 Manual Gun	HP Auto 2 Auto Guns
17H454	B	✓ CE				
17H455	B		✓ CE			
17K580	B			✓ CE		
17H456	B			✓ with laser		
17K636	B				✓ CE	
17H457	B				✓ with laser	
17K581	B					✓ CE
17H458	B					✓ with laser

* All auto guns can be actuated manually.

goind.com.au







Warnings

The following warnings are for the setup, use, grounding, maintenance, and repair of this equipment. The exclamation point symbol alerts you to a general warning and the hazard symbols refer to procedure-specific risks. When these symbols appear in the body of this manual or on warning labels, refer back to these Warnings. Product-specific hazard symbols and warnings not covered in this section may appear throughout the body of this manual where applicable.







 <h1 style="margin: 0;">WARNING</h1>	
   	<p>FIRE AND EXPLOSION HAZARD</p> <p>Flammable fumes, such as solvent and paint fumes, in work area can ignite or explode. Paint or solvent flowing through the equipment can cause static sparking. To help prevent fire and explosion:</p> <ul style="list-style-type: none"> • Use equipment only in well ventilated area. • Do not fill fuel tank while engine is running or hot; shut off engine and let it cool. Fuel is flammable and can ignite or explode if spilled on hot surface. • Eliminate all ignition sources; such as pilot lights, cigarettes, portable electric lamps, and plastic drop cloths (potential static arc). • Ground all equipment in the work area. See Grounding instructions. • Never spray or flush solvent at high pressure. • Keep work area free of debris, including solvent, rags and gasoline. • Do not plug or unplug power cords, or turn power or light switches on or off when flammable fumes are present. • Use only grounded hoses. • Hold gun firmly to side of grounded pail when triggering into pail. Do not use pail liners unless they are antistatic or conductive. • Stop operation immediately if static sparking occurs or you feel a shock. Do not use equipment until you identify and correct the problem. • Keep a working fire extinguisher in the work area.
    	<p>SKIN INJECTION HAZARD</p> <p>High-pressure spray is able to inject toxins into the body and cause serious bodily injury. In the event that injection occurs, get immediate surgical treatment.</p> <ul style="list-style-type: none"> • Do not aim the gun at, or spray any person or animal. • Keep hands and other body parts away from the discharge. For example, do not try to stop leaks with any part of the body. • Always use the nozzle tip guard. Do not spray without nozzle tip guard in place. • Use Graco nozzle tips. • Use caution when cleaning and changing nozzle tips. In the case where the nozzle tip clogs while spraying, follow the Pressure Relief Procedure for turning off the unit and relieving the pressure before removing the nozzle tip to clean. • Equipment maintains pressure after power is shut off. Do not leave the equipment energized or under pressure while unattended. Follow the Pressure Relief Procedure when the equipment is unattended or not in use, and before servicing, cleaning, or removing parts. • Check hoses and parts for signs of damage. Replace any damaged hoses or parts. • This system is capable of producing 3300 psi. Use Graco replacement parts or accessories that are rated a minimum of 3300 psi. • Always engage the trigger lock when not spraying. Verify the trigger lock is functioning properly. • Verify that all connections are secure before operating the unit. • Know how to stop the unit and bleed pressure quickly. Be thoroughly familiar with the controls.







WARNING

	<p>CARBON MONOXIDE HAZARD</p> <p>Exhaust contains poisonous carbon monoxide, which is colorless and odorless. Breathing carbon monoxide can cause death.</p> <ul style="list-style-type: none"> Do not operate in an enclosed area.
 	<p>EQUIPMENT MISUSE HAZARD</p> <p>Misuse can cause death or serious injury.</p> <ul style="list-style-type: none"> Do not operate the unit when fatigued or under the influence of drugs or alcohol. Do not exceed the maximum working pressure or temperature rating of the lowest rated system component. See Technical Data in all equipment manuals. Use fluids and solvents that are compatible with equipment wetted parts. See Technical Data in all equipment manuals. Read fluid and solvent manufacturer's warnings. For complete information about your material, request Safety Data Sheet (SDS) from distributor or retailer. Do not leave the work area while equipment is energized or under pressure. Turn off all equipment and follow the Pressure Relief Procedure when equipment is not in use. Check equipment daily. Repair or replace worn or damaged parts immediately with genuine manufacturer's replacement parts only. Do not alter or modify equipment. Alterations or modifications may void agency approvals and create safety hazards. Make sure all equipment is rated and approved for the environment in which you are using it. Use equipment only for its intended purpose. Call your distributor for information. Route hoses and cables away from traffic areas, sharp edges, moving parts, and hot surfaces. Do not kink or over bend hoses or use hoses to pull equipment. Keep children and animals away from work area. Comply with all applicable safety regulations.
	<p>PRESSURIZED ALUMINUM PARTS HAZARD</p> <p>Use of fluids that are incompatible with aluminum in pressurized equipment can cause serious chemical reaction and equipment rupture. Failure to follow this warning can result in death, serious injury, or property damage.</p> <ul style="list-style-type: none"> Do not use 1,1,1-trichloroethane, methylene chloride, other halogenated hydrocarbon solvents or fluids containing such solvents. Do not use chlorine bleach. Many other fluids may contain chemicals that can react with aluminum. Contact your material supplier for compatibility.
 	<p>MOVING PARTS HAZARD</p> <p>Moving parts can pinch, cut or amputate fingers and other body parts.</p> <ul style="list-style-type: none"> Keep clear of moving parts. Do not operate equipment with protective guards or covers removed. Pressurized equipment can start without warning. Before checking, moving, or servicing equipment, follow the Pressure Relief Procedure and disconnect all power sources.
	<p>TOXIC FLUID OR FUMES HAZARD</p> <p>Toxic fluids or fumes can cause serious injury or death if splashed in the eyes or on skin, inhaled, or swallowed.</p> <ul style="list-style-type: none"> Read Safety Data Sheet (SDS) to know the specific hazards of the fluids you are using. Store hazardous fluid in approved containers, and dispose of it according to applicable guidelines.

WARNING

	<p>BURN HAZARD Equipment surfaces and fluid that's heated can become very hot during operation. To avoid severe burns:</p> <ul style="list-style-type: none"> • Do not touch hot fluid or equipment.
	<p>PERSONAL PROTECTIVE EQUIPMENT Wear appropriate protective equipment when in the work area to help prevent serious injury, including eye injury, hearing loss, inhalation of toxic fumes, and burns. This protective equipment includes but is not limited to:</p> <ul style="list-style-type: none"> • Protective eyewear, and hearing protection. • Respirators, protective clothing, and gloves as recommended by the fluid and solvent manufacturer.
  	<p>BATTERY HAZARD The battery may leak, explode, cause burns, or cause an explosion if mishandled. Contents of an open battery can cause severe irritation and/or chemical burns. If on skin, wash with soap and water. If in eyes, flush with water for at least 15 minutes and get immediate medical attention.</p> <ul style="list-style-type: none"> • Only use the battery type specified for use with the equipment. See Technical Data. • Replace battery only in well-ventilated area and away from flammable or combustible materials, including paints and solvents. • Do not dispose of battery in fire or heat above 50°C (122°F). The battery is capable of exploding. • Do not throw into fire. • Do not expose battery to water or rain. • Do not disassemble, crush, or penetrate the battery. • Do not use or charge a battery that is cracked or damaged. • Follow local ordinances and/or regulations for disposal.
	<p>ELECTRIC SHOCK HAZARD Hazardous voltage is present in control box while engine is running.</p> <ul style="list-style-type: none"> • Turn off engine before servicing equipment.

Important Laser Information for Units with Laser Option

 WARNING	
	<p>LASER LIGHT HAZARD: AVOID DIRECT EYE CONTACT</p> <p>Eye exposure to Class IIIa/3R levels of laser light can potentially present an eye (retinal) injury hazard, including spot blindness or other retinal injury. To avoid direct eye exposure:</p> <ul style="list-style-type: none"> • Never look directly in to a laser beam or point the beam into the eyes of others, even at long distances. • Never shine the laser at mirror like surfaces which can cause specular reflections of the beam. • Always set the laser at a height and angle that prevents the beam from shining into people’s eyes. • Immediately terminate laser emissions if personnel, animals or reflective objects approach the beam. • Always turn off laser when unattended. • Do not remove any warning labels from the laser. • Only properly trained laser operators are to use this product. • Never allow beams to be aimed toward traffic, vehicles, or heavy equipment. Even when not damaging at long distances, the high brightness of lasers can distract or disrupt vehicle operations. • Never point a laser at an aircraft or law enforcement personnel. This is considered a felony in most locations, with the possibility of jail time, heavy fines or both. • Do not disassemble laser product. Return to factory for all service procedures. • Laser must be turned OFF when cleaning the lens, so as not to create unwanted laser refraction.
	<p>LASER RADIATION HAZARD</p> <p>Use of controls or adjustments or performance of procedures other than those specified herein may result in hazardous radiation exposure.</p> <ul style="list-style-type: none"> • Do not attempt to open or disassemble the laser housing under any circumstances. Doing so may cause exposure to potentially hazardous levels of laser radiation. • No serviceable parts within. Unit is factory sealed.
	<p>FIRE AND EXPLOSION HAZARD</p> <p>Connecting directly to a generator source can create a short or sparking under certain conditions.</p> <ul style="list-style-type: none"> • Only connect GL1700 to a dedicated 12 volt DC battery source.

Tip Selection

							
LL5213*	2 (5)				✓		
LL5215*	2 (5)					✓	
LL5217		4 (10)				✓	
LL5219		4 (10)					✓
LL5315		4 (10)			✓		
LL5317		4 (10)			✓		
LL5319		4 (10)				✓	
LL5321		4 (10)				✓	
LL5323		4 (10)				✓	
LL5325		4 (10)					✓
LL5327		4 (10)					✓
LL5329		4 (10)					✓
LL5331		4 (10)					✓
LL5333		4 (10)					✓
LL5335		4 (10)					✓
LL5355		4 (10)					✓
LL5417			6 (15)		✓		
LL5419			6 (15)		✓		
LL5421			6 (15)		✓		
LL5423			6 (15)			✓	
LL5425			6 (15)			✓	
LL5427			6 (15)			✓	
LL5429			6 (15)			✓	
LL5431			6 (15)				✓
LL5435			6 (15)				✓
LL5621				12 (30)	✓		
LL5623				12 (30)	✓		
LL5625				12 (30)	✓		
LL5627				12 (30)	✓		
LL5629				12 (30)	✓		
LL5631				12 (30)		✓	
LL5635				12 (30)		✓	
LL5639				12 (30)			✓

*Use 100 mesh filter to reduce tip clogs.

Component Identification (LLV 3900/5900)

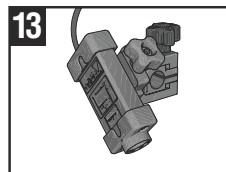
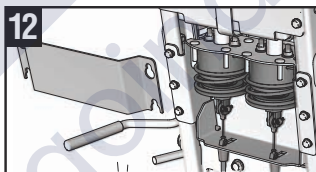
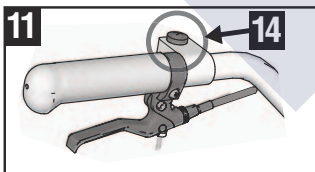
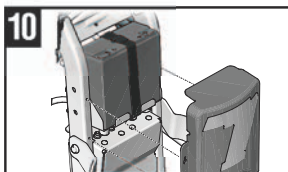
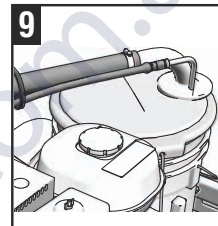
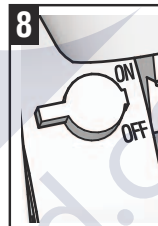
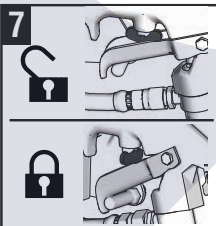
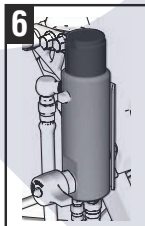
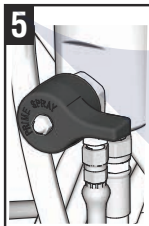
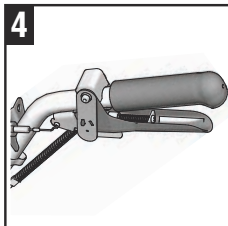
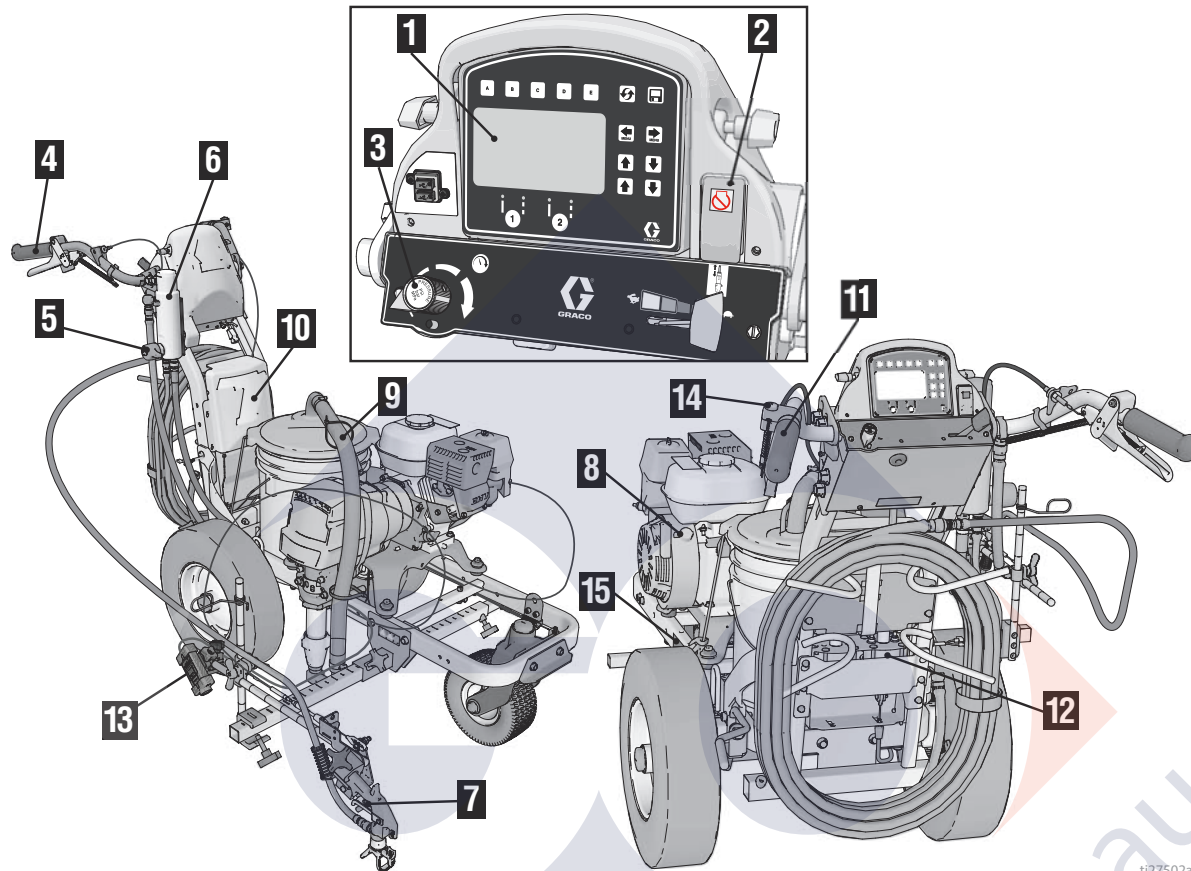

1	Display
2	Pump ON/OFF switch & Engine Stop switch
3	Pressure control
4	Manual spray gun trigger
5	Prime/Pressure relief valve
6	Filter
7	Trigger safety
8	Engine ON/OFF switch
9	Drain and siphon tubes

*10	12 volt battery
11	Turn control
*12	Gun actuators
*13	Layout laser
*14	Auto spray gun control button
15	Identification label

* HP Auto Series only.

Grounding Procedure (For Flammable Flushing Fluids Only)

--	--	--	--	--

This equipment must be grounded to reduce the risk of static sparking. Static sparking can cause fumes to ignite or explode. Grounding provides an escape wire for the electric current.

1. Position striper so that the tires are not on pavement.
2. Striper is shipped with a grounding clamp. Grounding clamp must attach to grounded object (e.g. metal sign post).

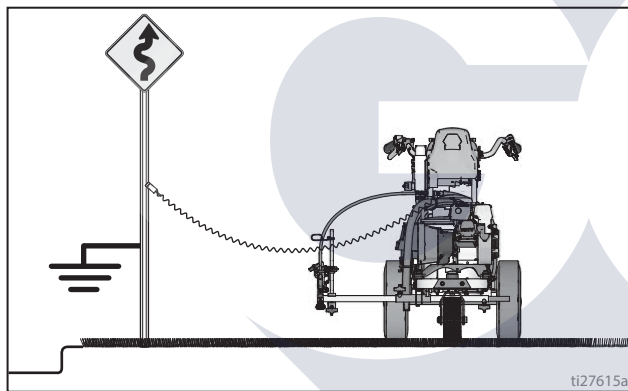

3. Disconnect grounding clamp after flushing is complete.

Pressure Relief Procedure

This equipment stays pressurized until pressure is manually relieved. To help prevent serious injury from pressurized fluid, such as skin injection, splashing fluid and moving parts, follow the Pressure Relief Procedure when you stop dispensing and before cleaning, checking, or servicing the equipment.

1. Perform **Grounding Procedure** if using flammable materials.
2. Set pump switch to **OFF**. Turn engine **OFF**.

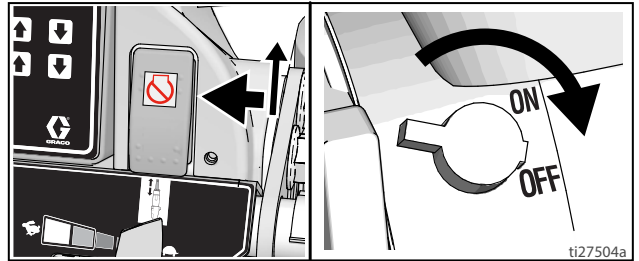

3. Turn pressure control to lowest setting. Trigger all guns to relieve pressure.

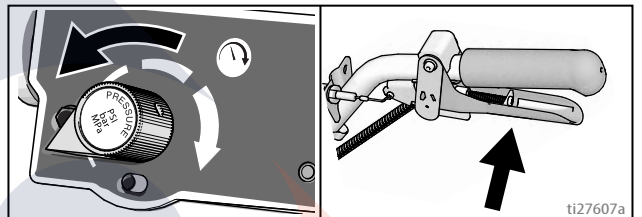

4. Engage all gun trigger locks. Turn prime valve down.

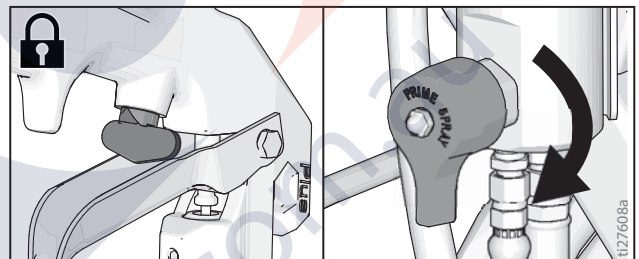

5. If you suspect the spray tip or hose is clogged or that pressure has not been fully relieved:
 - a. **VERY SLOWLY** loosen the tip guard retaining nut or the hose end coupling to relieve pressure gradually.
 - b. Loosen the nut or coupling completely.
 - c. Clear the obstruction in the hose or tip.

Setup/Startup

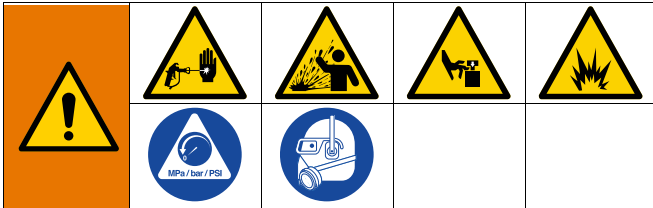

This equipment stays pressurized until pressure is manually relieved. To help prevent serious injury from pressurized fluid, such as skin injection, splashing fluid and moving parts, follow the Pressure Relief Procedure when you stop spraying and before cleaning, checking, or servicing the equipment.

1. Perform **Pressure Relief Procedure**, page 11.
2. Perform **Grounding Procedure (For Flammable Flushing Fluids Only)**, page 11, if using flammable materials.
3. Fill throat packing nut with Throat Seal Liquid (TSL) to decrease packing wear.

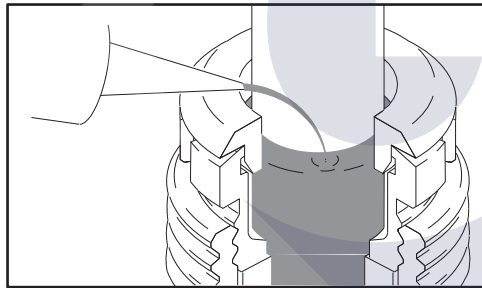

4. Check engine oil level. Add SAE 10W-30 (summer) or 5W-30 (winter). See engine manual.

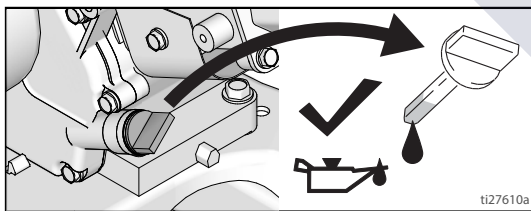

5. Fill fuel tank.

6. Set pump switch to **OFF**. Turn engine off.

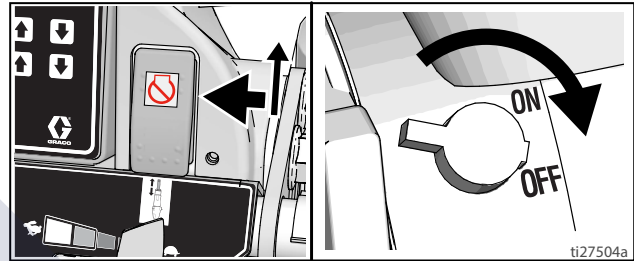

7. If removed, install strainer.

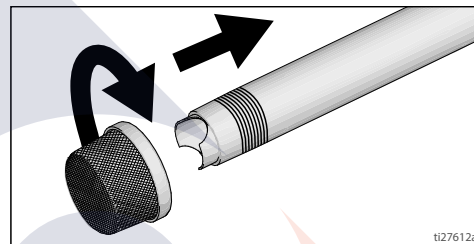

8. Turn prime valve down. Turn pressure control counterclockwise to lowest pressure.

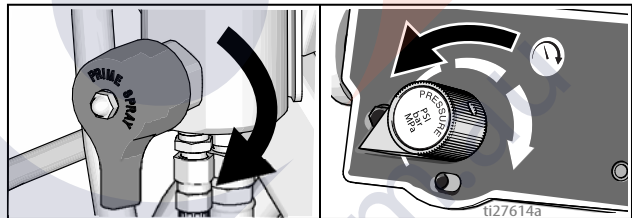

NOTE: Minimum hose size allowable for proper sprayer operation is 3/8 in. x 50 ft for LL3900/5900.

9. Place siphon tube set in grounded metal pail partially filled with flushing fluid. Attach ground wire to true earth ground. Use water to flush water-base paint and mineral spirits to flush oil-base paint and storage oil.

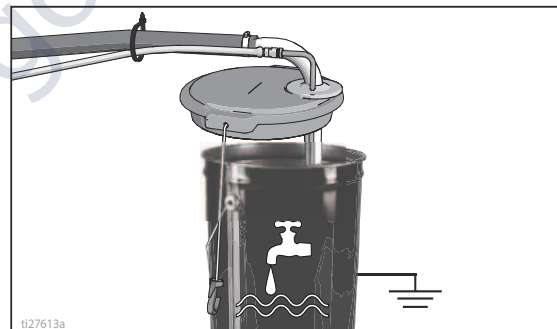

10. Start engine:

a. Move fuel valve to open.

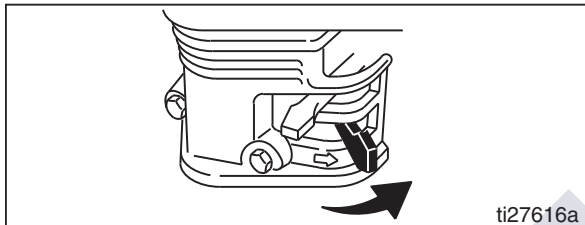

b. Move choke to closed.

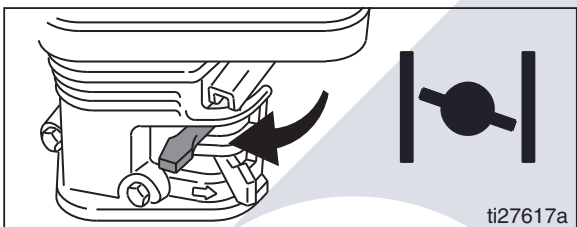

c. Set throttle to fast.

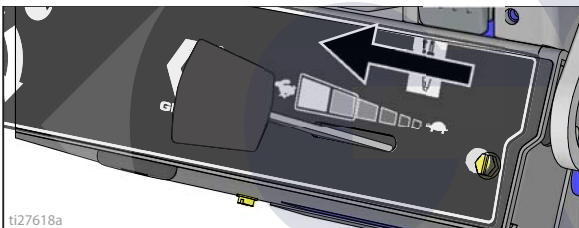

d. Set engine switch to ON.

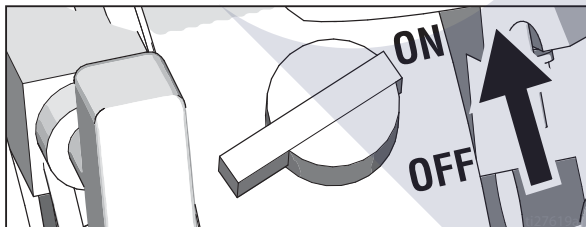

e. Pull starter cord.

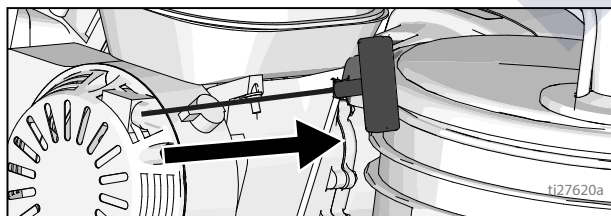

11. After engine starts, move choke to open.

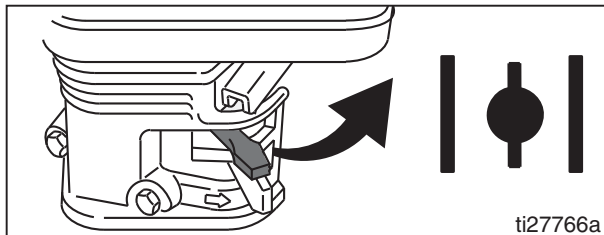

12. Set throttle to desired setting.

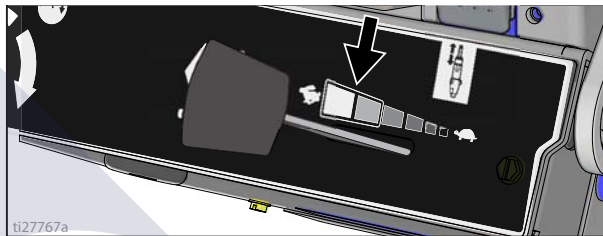

13. Digital display is functional after engine starts.



Setup/Startup

14. Set pump switch to **ON** (pump is now active).



15. Increase pressure control enough to start pump. Allow fluid to circulate for 15 seconds.

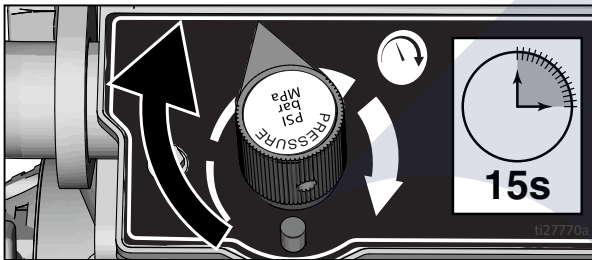

16. Turn pressure down, turn prime valve horizontal. Disengage gun trigger lock.

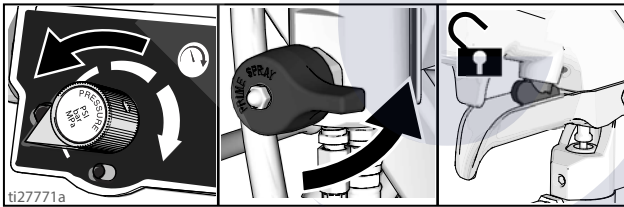

17. Hold all guns against a grounded metal flushing pail. Trigger guns and increase fluid pressure slowly until pump runs smoothly.

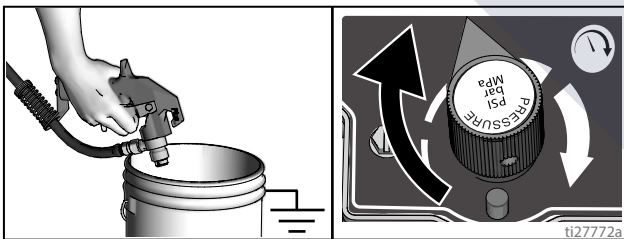

<p>High-pressure spray is able to inject toxins into the body and cause serious bodily injury. Do not stop leaks with hand or rag.</p>			

18. Inspect fittings for leaks. If leaks occur, turn sprayer OFF immediately. Perform **Pressure Relief Procedure**. Tighten leaky fittings. Repeat **Setup/Startup**, steps 1 - 17. If no leaks, continue to trigger gun until system is thoroughly flushed. Proceed to step 18.

19. Place siphon tube in paint pails.

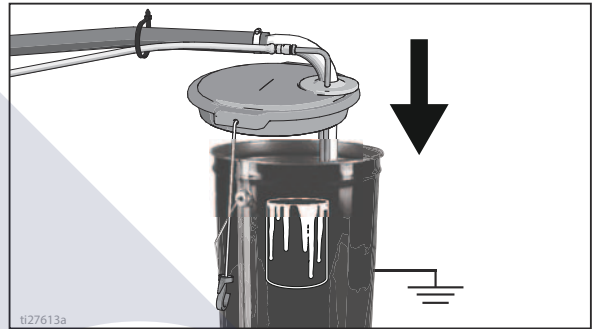

20. Trigger all guns again into a flushing fluid pail until paint appears. Assemble tips and guards.

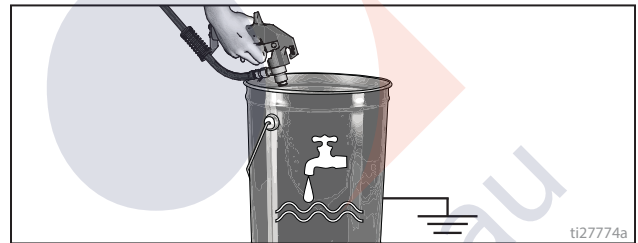

SwitchTip and Guard Assembly

1. Engage trigger lock. Use end of SwitchTip to press OneSeal into tip guard, with curve matching tip bore.

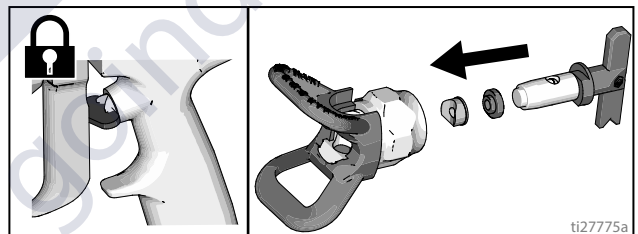

2. Insert SwitchTip in tip bore and firmly thread assembly onto gun.

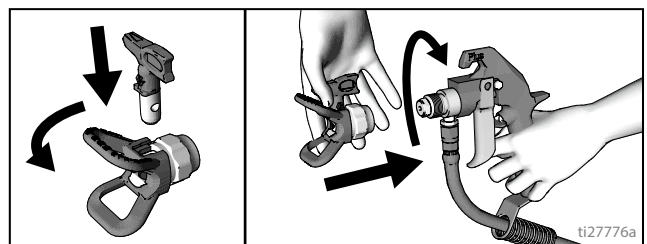

Gun Placement

Install Guns

1. Insert guns into gun holder. Tighten clamps.

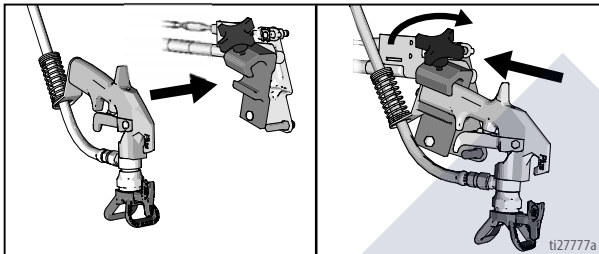

Another option can be to swing the gun out at an angle and rotate the tip guard. This results in better visibility for the user.

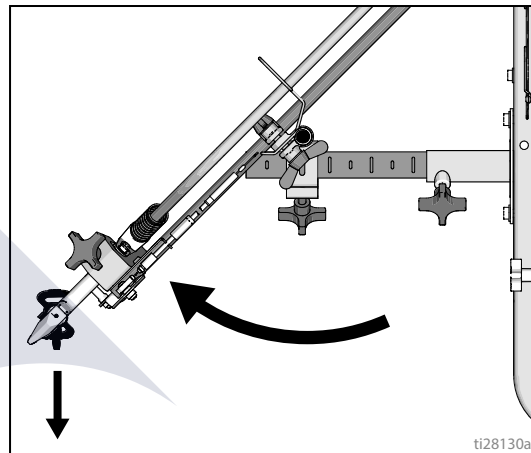

Position Gun

2. Position gun: up/down, forward/reverse, left/right. See **Gun Positions Chart**, page 17 for examples.

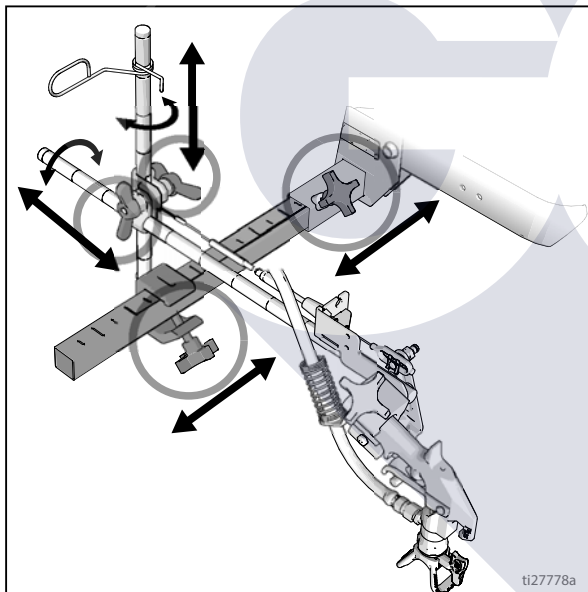

Select Guns (Standard Series)

3. Connect gun cables to left or right gun selector plates.

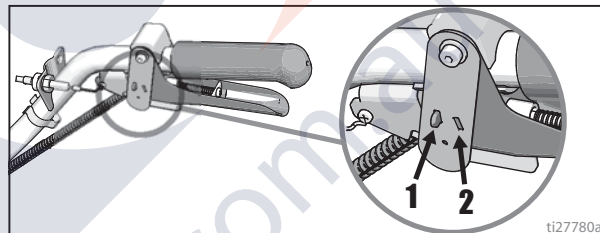

- a. One gun: Disconnect one gun selector plate from trigger.



- b. Both guns simultaneously: Adjust both gun selector plates to the same position.



- c. Solid-skip and skip-solid: Adjust solid-line gun to position 1 and skip-line to position 2.



NOTE: When striping above a curb, the mounting clamp can be rotated for clearance.

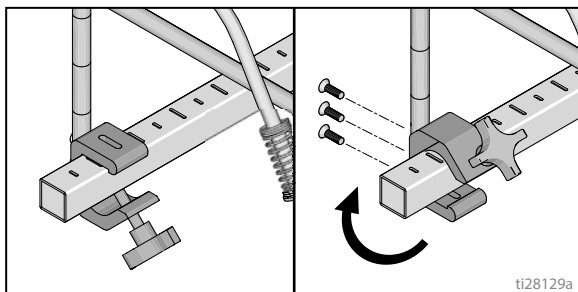

Select Auto Guns (HP Auto Series)

1. Use the gun selector buttons to determine which guns are active. Each gun selector has 3 settings: continuous line, OFF and programmed line pattern.

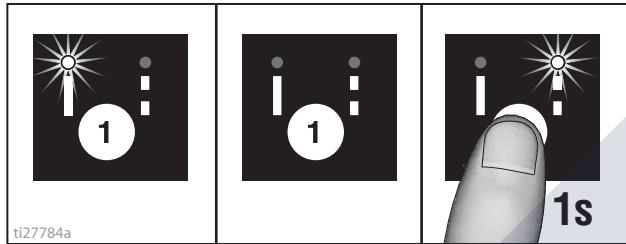

2. Use the gun trigger control to actuate auto guns.

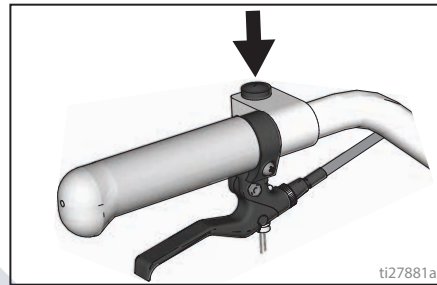

4 Examples:

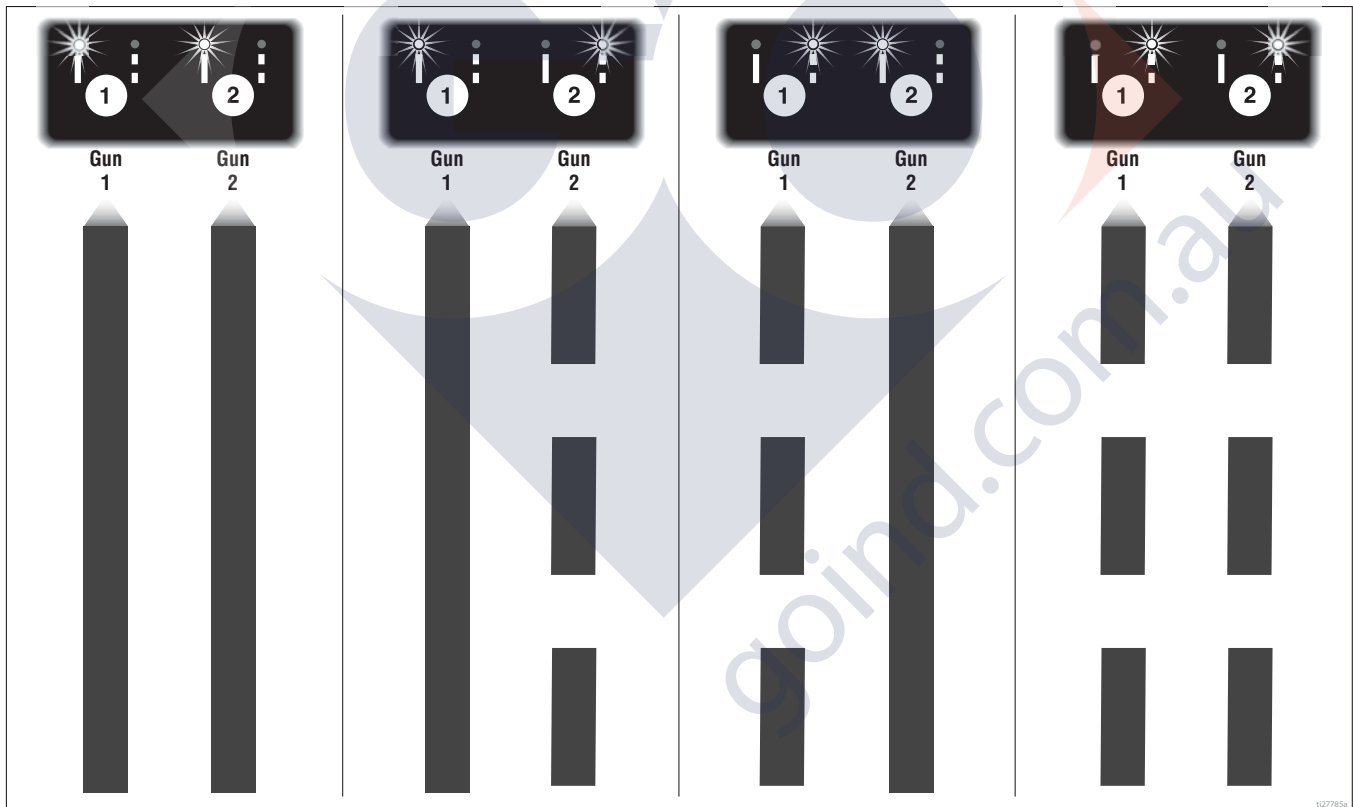

Gun Positions Chart

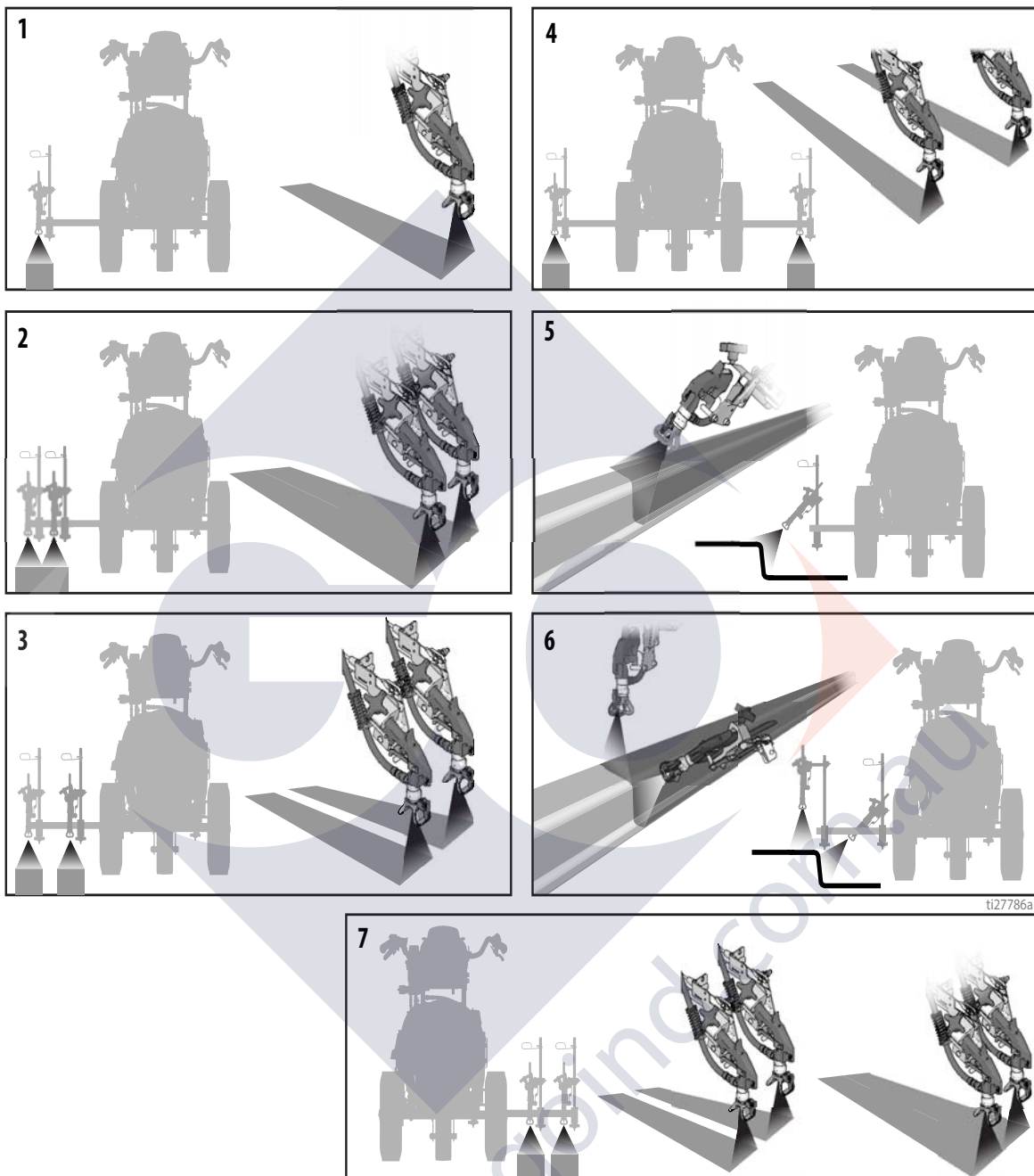

1	One line
2	One line up to 24 in. (61cm) wide
3	Two lines
4	One line or two lines to spray around obstacles
5	One gun curb
6	Two gun curb
7	Two lines or one line up to 24 in. (61 cm) wide

Gun Arm Mounts

This unit is equipped with front and rear gun arm mounts.

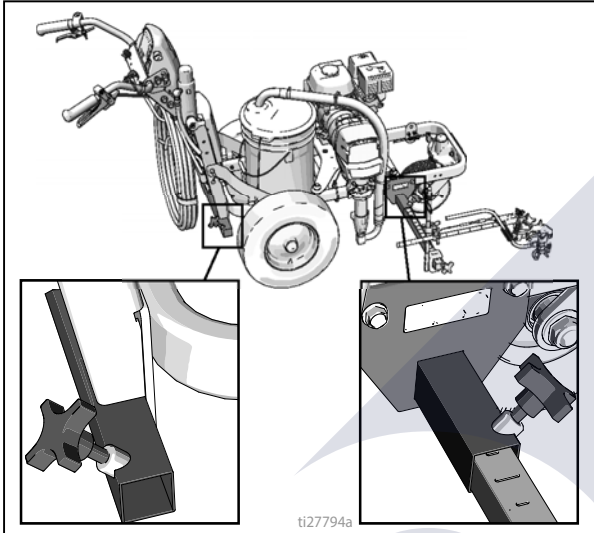

4. Tighten gun arm knob into gun arm mounting slot.

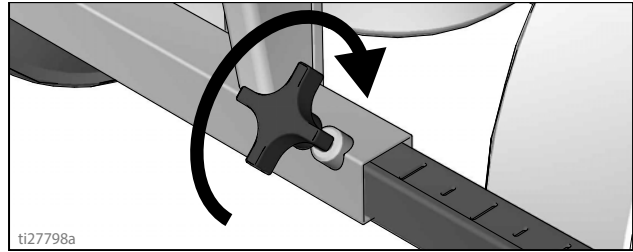

NOTICE

Make sure all hoses, cables, and wires are properly routed through brackets and do NOT rub on tire. Contact with tire will result in damaged hoses, cables, and wires.

Change Gun Position (Left and Right)

Removal

1. Loosen vertical gun arm knob on gun arm mounting bar and remove.

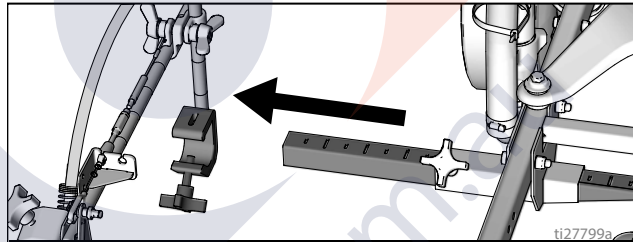

Change Gun Position (Front and Back)

1. Loosen gun arm knob and remove from gun arm mounting slot.

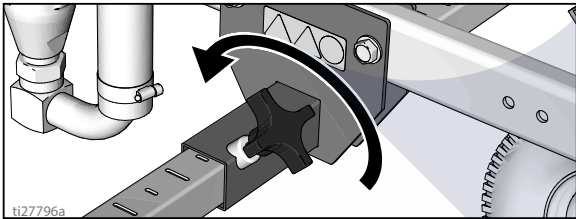

2. Slide gun arm assembly (including gun and hoses) out from gun arm mounting slot.

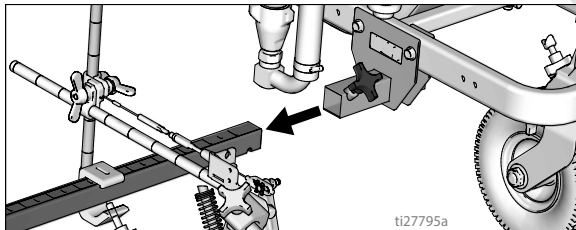

3. Slide gun arm assembly into desired gun arm mounting slot.

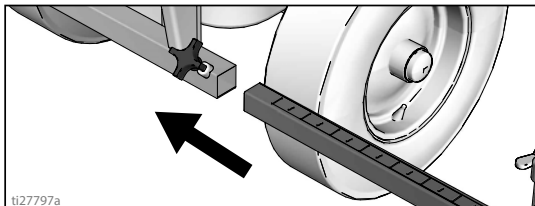

2. Extend mounting bar on opposite side of the machine.

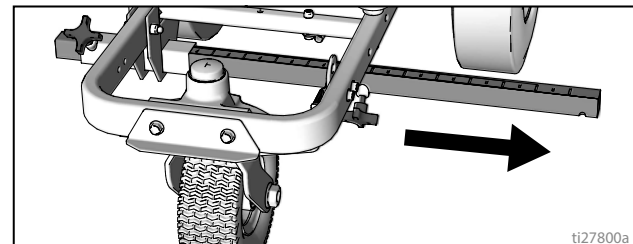

Installation

1. Install vertical gun mount onto gun bar.

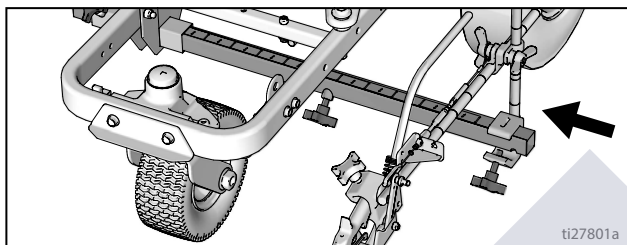

NOTE: Make sure all hoses, cables, and wires are properly routed through brackets.

No fluid spray

2. Turn screw in handle clockwise if spray icon appears before fluid spray starts.

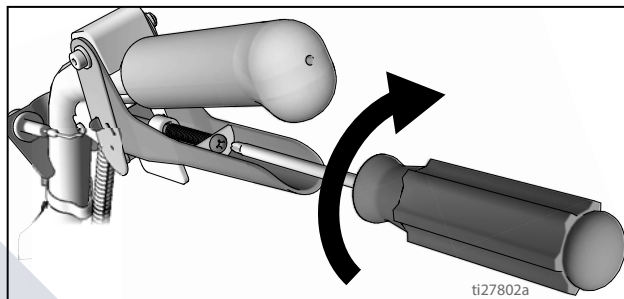

Trigger Sensor Adjustment

1. Start striper engine. Engage trigger. Spray icon should appear simultaneously with start of fluid spray.

Standard Series

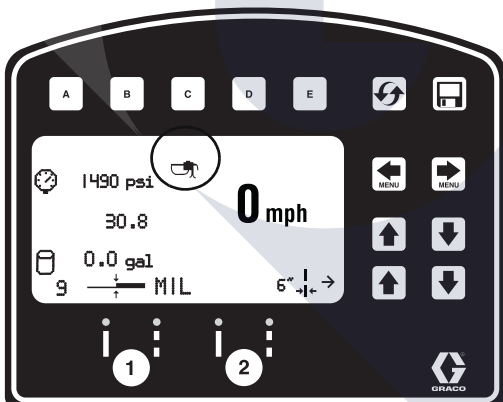

HP Auto Series

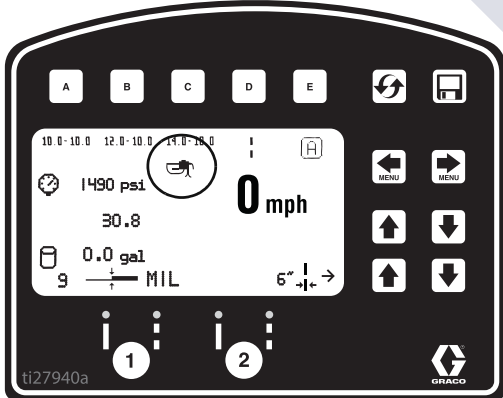

No spray icon

3. Turn screw in handle counterclockwise if fluid spray starts before spray icon appears.

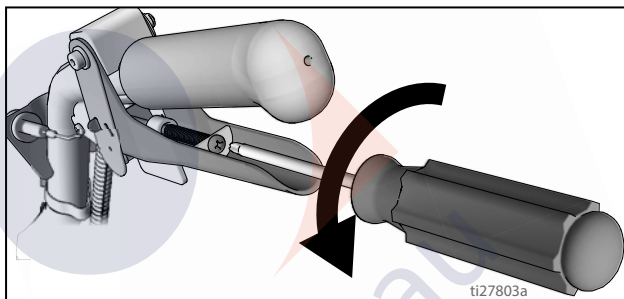

4. Continue adjusting screw in handle until timing of spray icon and fluid spray are synchronized. Adjustment of the gun cables might be necessary.

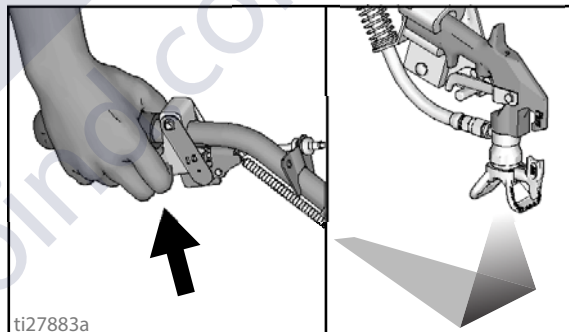

Gun Cable Adjustment

Adjusting the gun cable will increase or decrease the gap between the trigger plate and the gun trigger. To adjust trigger gap, perform the steps below.

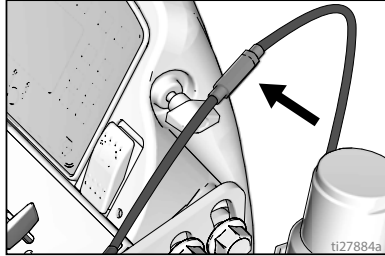

Standard Series

HP Auto Series

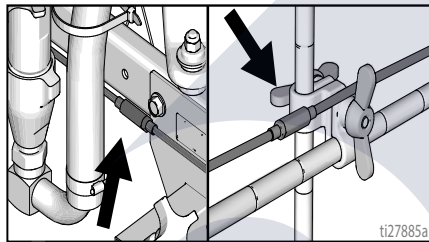

1. Use wrench to loosen locking nut on cable adjuster.

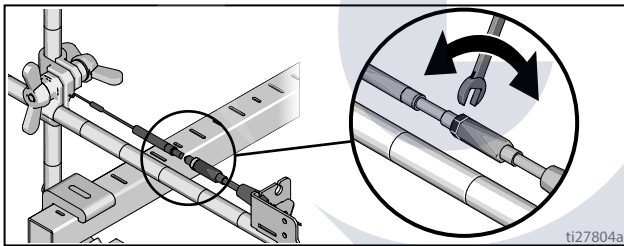

2. Loosen or tighten adjuster until desired result is achieved. **NOTE:** More thread exposed means less gap between gun trigger and trigger plate.
3. Use wrench to tighten locking nut on the adjuster.

Adding Gun Cable (HP Auto Series)

The HP Auto Series can be equipped with two gun actuators. Each gun actuator is capable of operating one cable.

1. Select cable end with adjuster.
2. Install exposed cable through cable bracket slot.

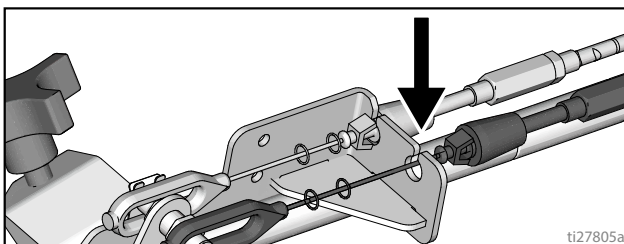

3. Insert plastic cable retainer into cable bracket hole.

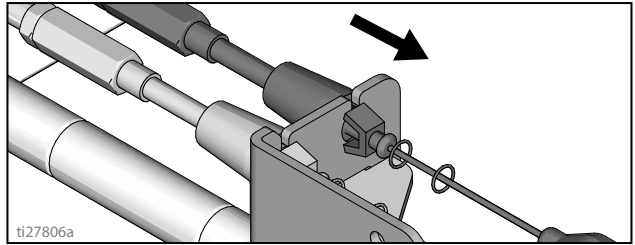

4. Install cable end onto trigger plate pin and install clip.

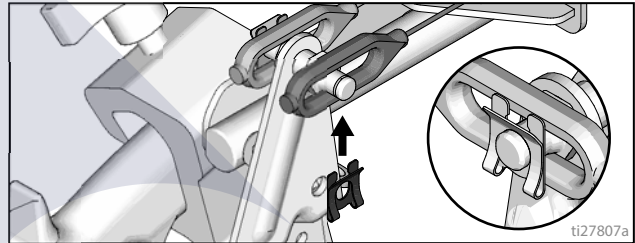

5. Route cable around unit and up through cable holes behind hose mount.

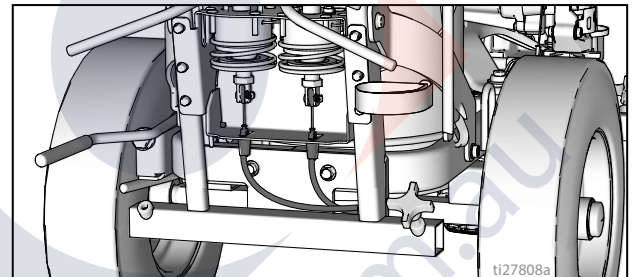

6. Route cable end loop through rectangular hole in bracket and insert plastic cable retainer into the actuator bracket. Install cable end onto actuator rod and install pin.

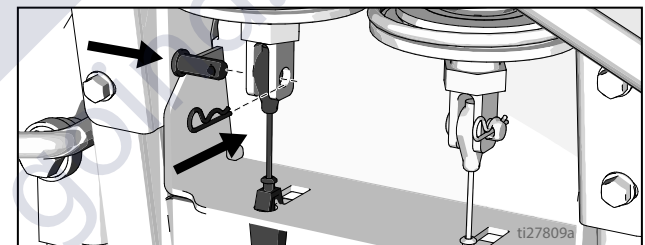

Straight Line Adjustment

The front wheel is set to center the unit and allow the operator to form straight lines. Over time, the wheel may become misaligned and will need to be readjusted. To re-center the front wheel, perform the following steps:

1. Loosen bolt on the front wheel bracket.

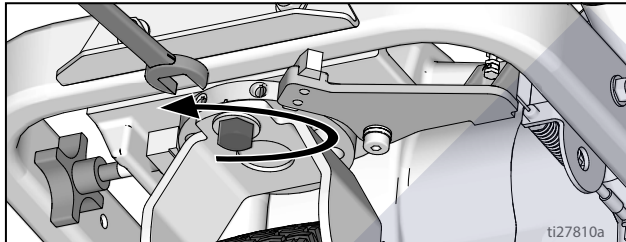

4. Roll the striper. Repeat steps 2 and 3 until striper rolls straight. Tighten bolt on wheel alignment plate to lock the new wheel setting.

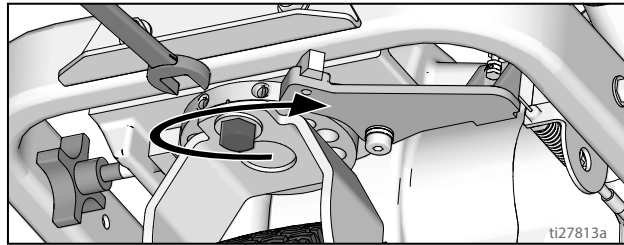

2. If striper arcs to the right, loosen left set screw and tighten right set screw for fine tune adjustment.

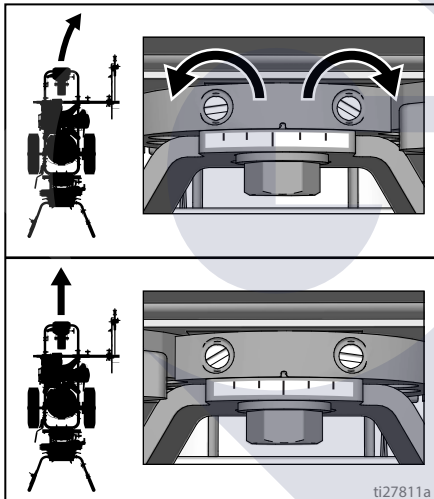

3. If striper arcs to the left, loosen right set screw and tighten left set screw.

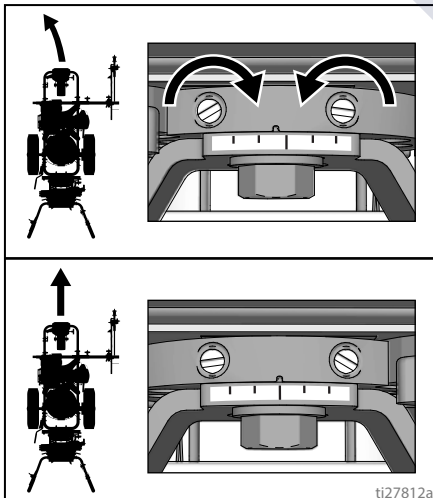

Handle Bar Adjustment

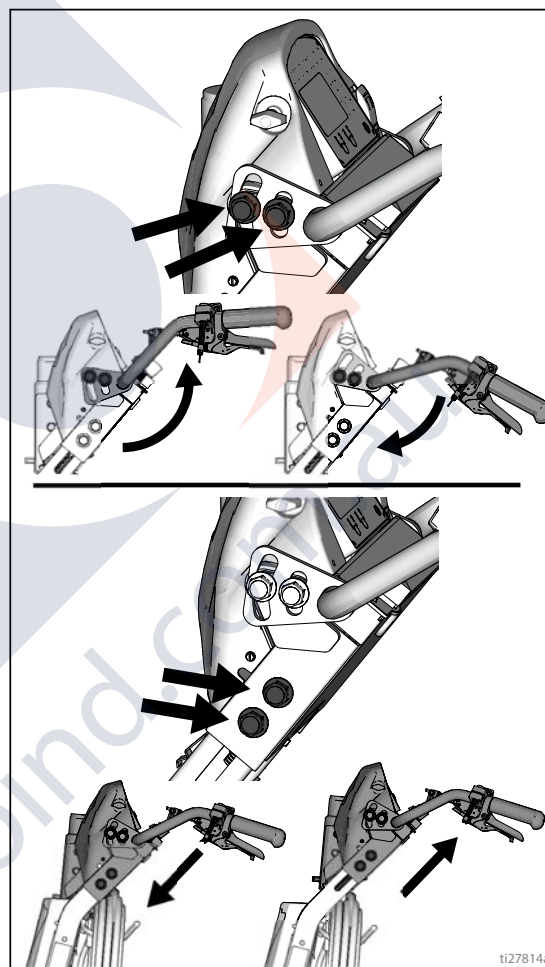

Dot Laser (if applicable)

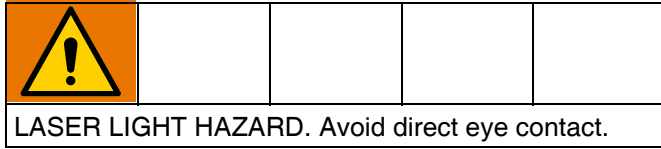

1. Remove battery cover.

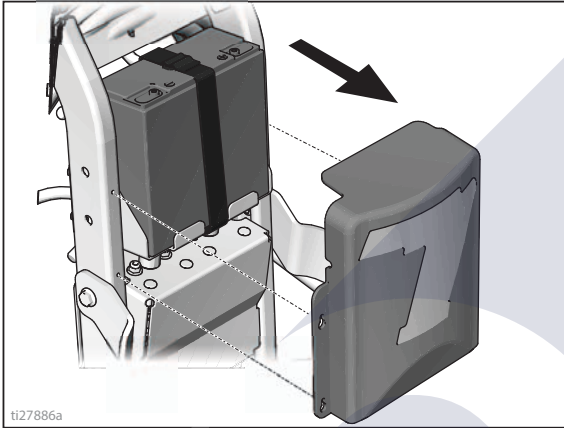

2. Attach ON/OFF switch to desired location on the handle bar.

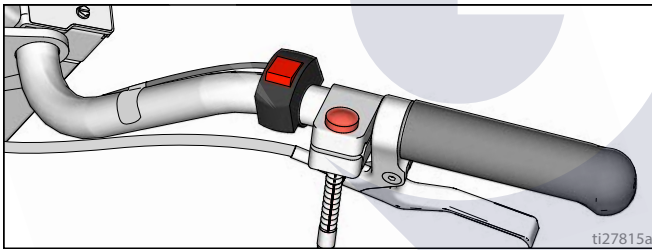

3. Attach laser to desired location on the gun arm.

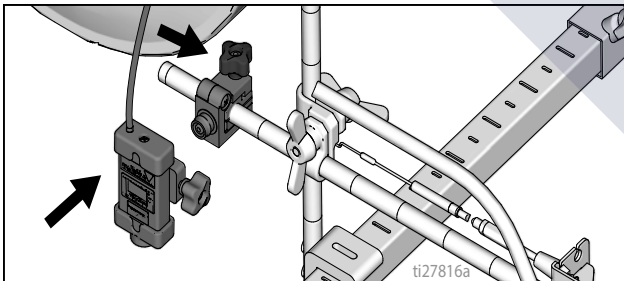

4. Route wires from the switch to the battery and connect to the (+) and (-) terminals.

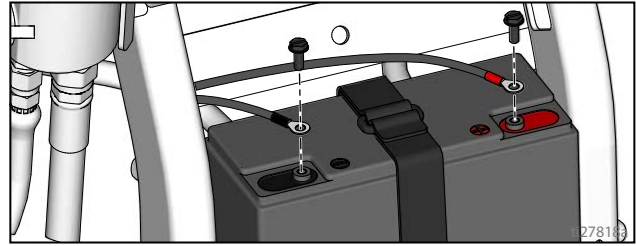

5. Connect the switch leads to the wire harness.

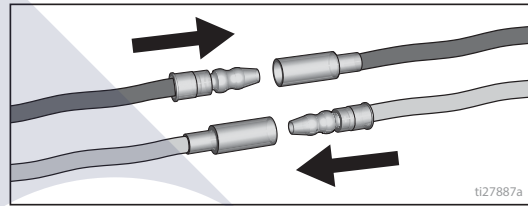

6. Reattach battery cover.

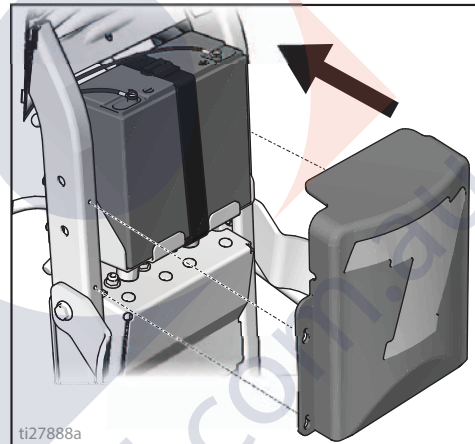

7. Turn on laser and position dot underneath gun head.

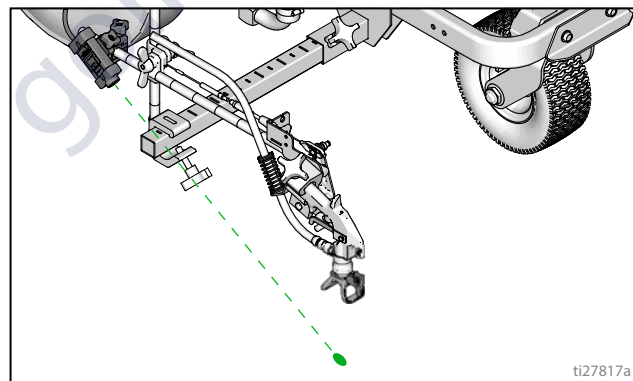

Cleanup

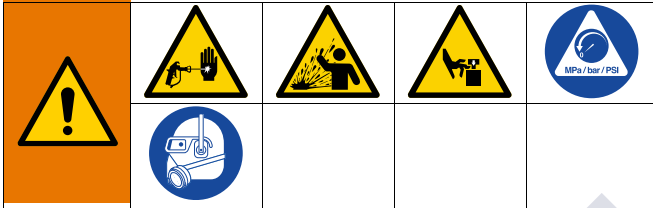

This equipment stays pressurized until pressure is manually relieved. To help prevent serious injury from pressurized fluid, such as skin injection, splashing fluid and moving parts, follow the Pressure Relief Procedure when you stop dispensing and before cleaning, checking, or servicing the equipment.

1. Perform **Pressure Relief Procedure**, page 11.
2. Remove guard and SwitchTip from all guns.

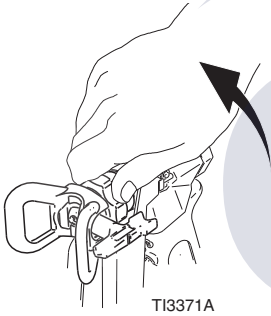

TI3371A

3. Unscrew cap, remove filter. Assemble without filter.

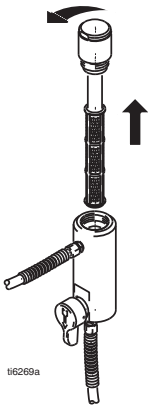

ti6269a

4. Clean filter, guard and SwitchTip in flushing fluid.

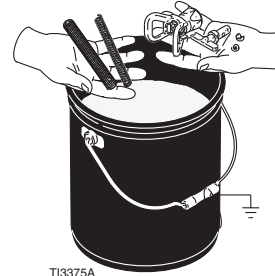

TI3375A

FLUSH

5. Place siphon tube set in grounded metal pail partially filled with flushing fluid. Attach ground wire to true earth ground. Perform Startup steps 10 - 17 (see page 13) to flush out paint in sprayer. Use water to flush water-base paint and mineral spirits solvent (also called white spirit) to flush oil-base paint.
6. Hold gun against paint bucket and pull trigger until water or solvent appears.

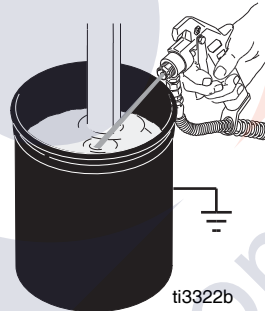

ti3322b

7. Move gun to solvent or water bucket. Hold gun against bucket and pull trigger until the system is thoroughly flushed.
8. Fill pump with Pump Armor and reassemble filter, guard and SwitchTip.
9. Each time you spray and store, fill throat packing nut with TSL to decrease packing wear.