

# Finex Airspray Package Sprayer

312473B

ENG

Package solutions for pumping and spraying finishing materials. For professional use only.



### Important Safety Instructions

Read all warnings and instructions in this manual and in your respective pump manual. Save these instructions.

### Models:

#### 289353 with Finex Airspray Gun

100 psi (7 bar, 0.7 MPa) Maximum Working Pressure

#### 289354 with Finex HVLP Gun

100 psi (7 bar, 0.7 MPa) Maximum Working Pressure

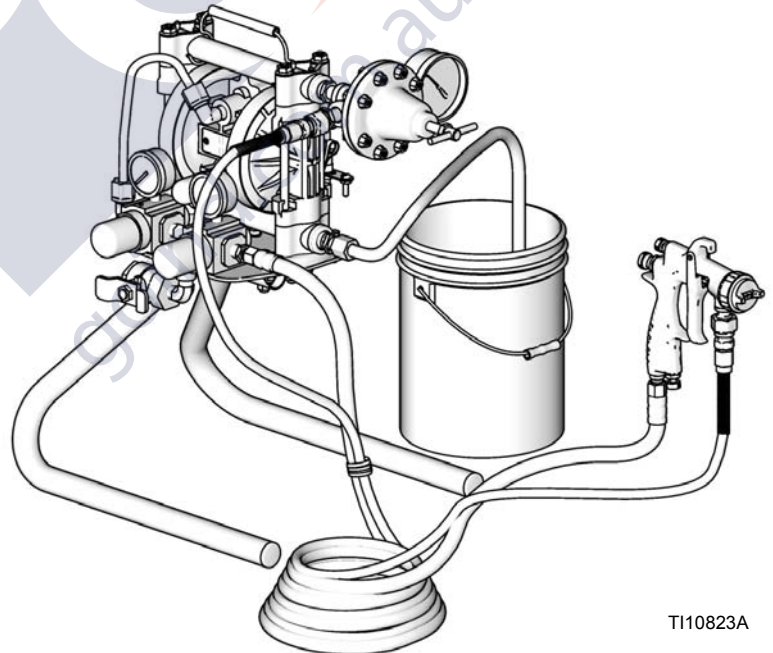

T110823A



# Contents

<b>Related Manuals</b> .....	<b>2</b>	<b>Flush</b> .....	<b>9</b>
<b>Warnings</b> .....	<b>3</b>	<b>Prime</b> .....	<b>10</b>
<b>Installation</b> .....	<b>5</b>	<b>Spraying</b> .....	<b>11</b>
Grounding .....	5	<b>Shutdown</b> .....	<b>11</b>
Flush Before Using Equipment .....	5	<b>Maintenance</b> .....	<b>12</b>
<b>Components</b> .....	<b>6</b>	<b>Troubleshooting</b> .....	<b>13</b>
Sprayer Components .....	6	<b>Parts</b> .....	<b>14</b>
Required Components (not included) .....	6	Finex Sprayer Package .....	14
Recommended Components .....	6	<b>Dimensions</b> .....	<b>15</b>
<b>Pump Operation and Repair</b> .....	<b>6</b>	<b>Technical Data</b> .....	<b>15</b>
<b>Pressure Relief</b> .....	<b>6</b>	<b>Graco Standard Warranty</b> .....	<b>16</b>
<b>Typical Installation</b> .....	<b>7</b>	<b>Graco Information</b> .....	<b>16</b>
<b>Setup/Installation</b> .....	<b>8</b>		
<b>Grounding</b> .....	<b>9</b>		





# Related Manuals





Manual	Description
308553	Husky™ 307 Air-Operated Diaphragm Pumps
312388	Finex™ Gun
308325	Fluid Pressure Regulators

goind.com.au

# Warnings

The following warnings are for the setup, use, grounding, maintenance, and repair of this equipment. The exclamation point symbol alerts you to a general warning and the hazard symbol refers to procedure-specific risk. Refer back to these warnings. Additional, product-specific warnings may be found throughout the body of this manual where applicable.

 <b>WARNING</b>	
	<p><b>FIRE AND EXPLOSION HAZARD</b></p> <p>Flammable fumes, such as solvent and paint fumes, in <b>work area</b> can ignite or explode. To help prevent fire and explosion:</p> <ul style="list-style-type: none"> <li>• Use equipment only in well ventilated area.</li> <li>• Eliminate all ignition sources; such as pilot lights, cigarettes, portable electric lamps, and plastic drop cloths (potential static arc).</li> <li>• Keep work area free of debris, including solvent, rags and gasoline.</li> <li>• Do not plug or unplug power cords, or turn power or light switches on or off when flammable fumes are present.</li> <li>• Ground all equipment in the work area. See <b>Grounding</b> instructions.</li> <li>• Use only grounded hoses.</li> <li>• Hold gun firmly to side of grounded pail when triggering into pail.</li> <li>• If there is static sparking or you feel a shock, <b>stop operation immediately</b>. Do not use equipment until you identify and correct the problem.</li> <li>• Keep a working fire extinguisher in the work area.</li> </ul>
	<p><b>EQUIPMENT MISUSE HAZARD</b></p> <p>Misuse can cause death or serious injury.</p> <ul style="list-style-type: none"> <li>• Do not operate the unit when fatigued or under the influence of drugs or alcohol.</li> <li>• Do not exceed the maximum working pressure or temperature rating of the lowest rated system component. See <b>Technical Data</b> in all equipment manuals.</li> <li>• Use fluids and solvents that are compatible with equipment wetted parts. See <b>Technical Data</b> in all equipment manuals. Read fluid and solvent manufacturer's warnings. For complete information about your material, request MSDS forms from distributor or retailer.</li> <li>• Check equipment daily. Repair or replace worn or damaged parts immediately with genuine manufacturer's replacement parts only.</li> <li>• Do not alter or modify equipment.</li> <li>• Use equipment only for its intended purpose. Call your distributor for information.</li> <li>• Route hoses and cables away from traffic areas, sharp edges, moving parts, and hot surfaces.</li> <li>• Do not kink or over bend hoses or use hoses to pull equipment.</li> <li>• Keep children and animals away from work area.</li> <li>• Comply with all applicable safety regulations.</li> </ul>
	<p><b>PRESSURIZED EQUIPMENT HAZARD</b></p> <p>Fluid from the gun/dispense valve, leaks, or ruptured components can splash in the eyes or on skin and cause serious injury.</p> <ul style="list-style-type: none"> <li>• Follow <b>Pressure Relief Procedure</b> in this manual, when you stop spraying and before cleaning, checking, or servicing equipment.</li> <li>• Tighten all fluid connections before operating the equipment.</li> <li>• Check hoses, tubes, and couplings daily. Replace worn or damaged parts immediately.</li> </ul>

 <b>WARNING</b>	
	<p><b>TOXIC FLUID OR FUMES HAZARD</b></p> <p>Toxic fluids or fumes can cause serious injury or death if splashed in the eyes or on skin, inhaled, or swallowed.</p> <ul style="list-style-type: none"> <li>• Read MSDS's to know the specific hazards of the fluids you are using.</li> <li>• Store hazardous fluid in approved containers, and dispose of it according to applicable guidelines.</li> <li>• Always wear impervious gloves when spraying or cleaning equipment.</li> </ul>
	<p><b>PERSONAL PROTECTIVE EQUIPMENT</b></p> <p>You must wear appropriate protective equipment when operating, servicing, or when in the operating area of the equipment to help protect you from serious injury, including eye injury, inhalation of toxic fumes, burns, and hearing loss. This equipment includes but is not limited to:</p> <ul style="list-style-type: none"> <li>• Protective eyewear</li> <li>• Clothing and respirator as recommended by the fluid and solvent manufacturer</li> <li>• Gloves</li> <li>• Hearing protection</li> </ul>
	<p><b>PRESSURIZED ALUMINUM PARTS HAZARD</b></p> <p>Do not use 1,1,1-trichloroethane, methylene chloride, other halogenated hydrocarbon solvents or fluids containing such solvents in pressurized aluminum equipment. Such use can cause serious chemical reaction and equipment rupture, and result in death, serious injury, and property damage.</p>

# Installation

## Grounding

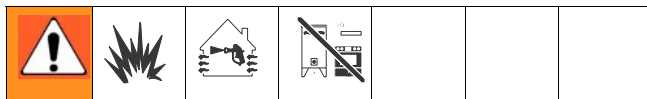

The equipment must be grounded. Grounding reduces the risk of static and electric shock by providing an escape wire for the electrical current due to static build up or in the event of a short circuit.

**Pump:** use the ground wire and clamp (supplied). See FIG. 1. Use the ground screw (GS) and lock washer (LW) to attach the ground wire (N) at the rear of the air motor. Tighten the screw securely. Connect the other end of the ground wire to a true earth ground (P).

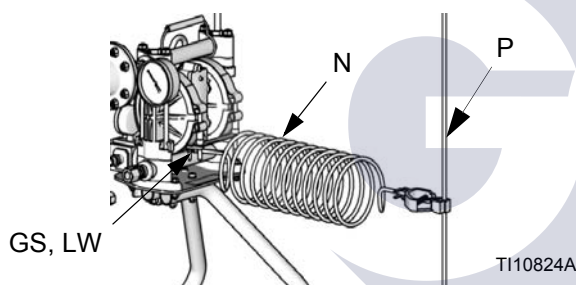

FIG. 1. Ground Wire

**Air and fluid hoses:** use only electrically conductive hoses.

**Air compressor:** follow manufacturer's recommendations.

**Spray gun / Dispense valve:** ground through connection to a properly grounded air or fluid hose and pump. Air hose is conductive and used to ground gun. If adding lengths to hose be sure to use conductive hoses.

**Fluid supply container:** follow local code.

**Object being sprayed:** follow local code.



**Solvent pails used when flushing:** follow local code. Use only conductive metal pails, placed on a grounded surface. Do not place the pail on a nonconductive surface, such as paper or cardboard, which interrupts grounding continuity.

**To maintain grounding continuity when flushing or relieving pressure:** hold metal part of the spray gun/dispense valve firmly to the side of a grounded metal pail, then trigger the gun/valve.

## Flush Before Using Equipment

The equipment was tested with water. To avoid contaminating your fluid with water, flush the equipment with a compatible solvent before using the equipment. See your pump manual. See **Related Manuals**, page 2.

## Controls and Components

						
Trapped air can cause the pump to cycle unexpectedly, which could result in serious injury from splashing or moving parts.						

## Sprayer Controls

- **Pump air pressure regulator (C):** a locking regulator to adjust air pressure to the motor and fluid outlet pressure of pump. View the air pressure gauge to read air pressure.
- **Gun air pressure regulator (D):** a locking regulator to adjust air pressure to the gun. View the air pressure gauge to read air pressure.
- **Fluid pressure regulator (E):** used to adjust the fluid pressure to the spray gun.
- **Bleed-type master air valve (L):** required in your system to relieve air trapped between it and the air motor when the valve is closed.

## Required Components (not included)

- **Main Air Supply (J):** connects air supply from air compressor to pump.

## Recommended Components

- **Air line filter (F):** removes harmful contaminants from entering the air control module and air motor.
- **Air line moisture drain valve (M):** installed at the bottom of each air line drop, to drain moisture.

## Pump Operation and Repair

						
---	---	--	---	--	--	--

Follow the **Pressure Relief Procedure** in your pump manual before cleaning or repairing your equipment.

For complete instructions and warnings see your respective pump manual. See **Related Manuals**, page 2.

# Typical Installation

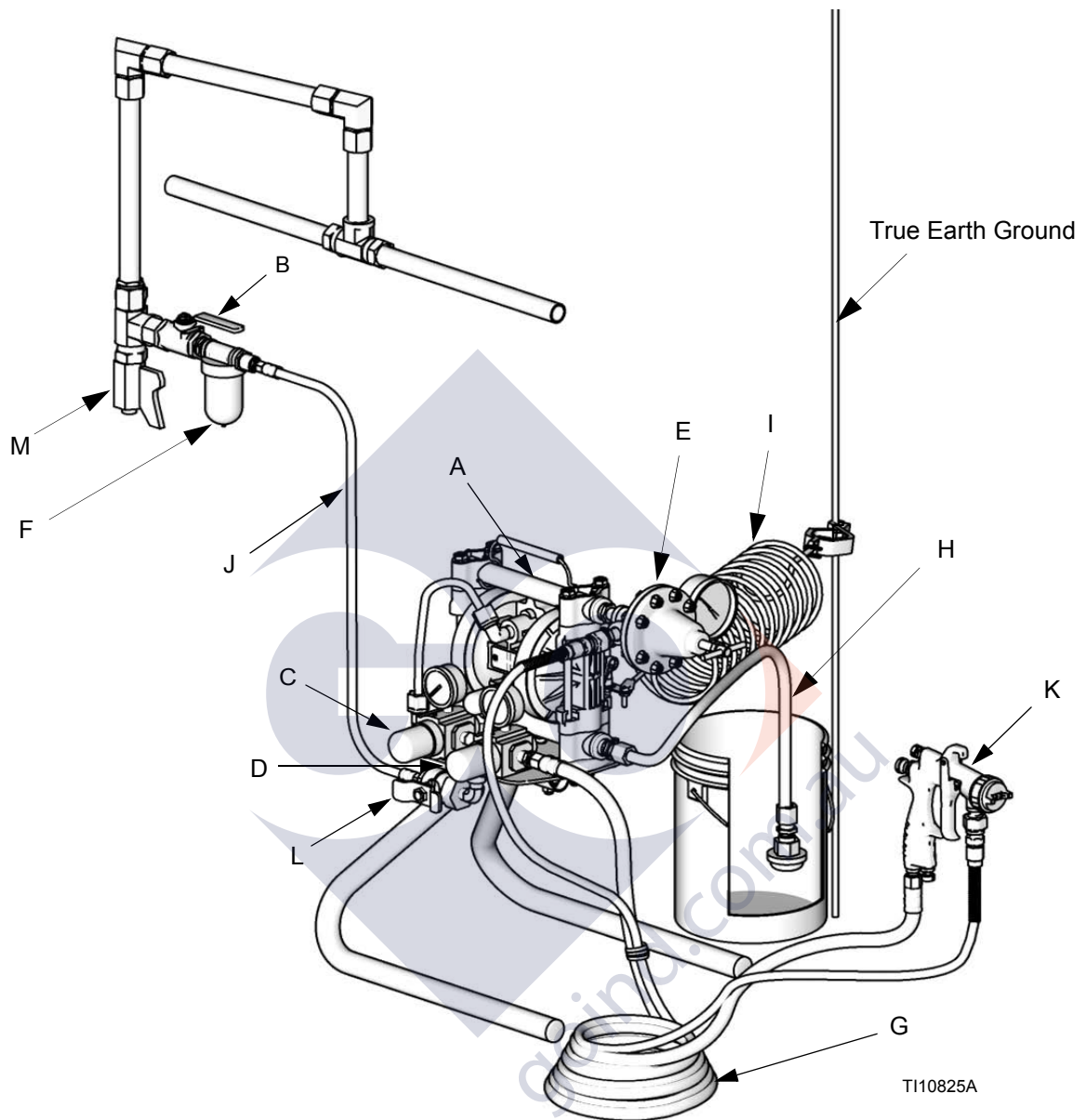

**FIG. 2: Typical Installation (Finex Airspray Gun Shown)**

**Key:**

- |   |  |   |                                   |
|---|--|---|-----------------------------------|
| A | Pump                                     | G | Hose Set                          |
| B | Bleed-type Master Air Line Shutoff Valve | H | Suction Hose                      |
| C | Pump Air Pressure Regulator              | I | Pump Ground Wire (required)       |
| D | Gun Air Pressure Regulator               | J | Main Air Supply Line              |
| E | Gun Fluid Pressure Regulator             | K | Spray Gun, Finex Airspray or HVLP |
| F | Air Filter                               | L | Bleed Type Master Air Valve       |
|   |  | M | Air Line Moisture Drain           |

# Pressure Relief



Follow pressure relief procedure when you stop spraying and before cleaning, checking, or servicing the equipment.

1. Shut off the bleed-type air valve.

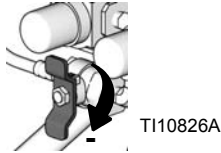

2. Hold the gun firmly against a grounded metal pail and trigger the gun.

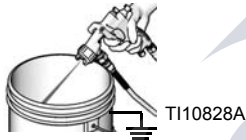

3. Connect the gun fluid hose to fluid regulator. Tighten securely.

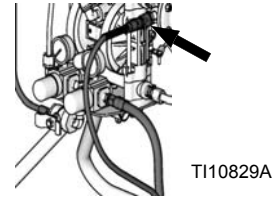

4. Connect the fluid hose to the gun. Tighten securely.

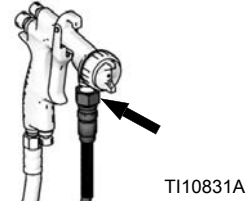

5. Ground the pump. See **Grounding**, page 9.

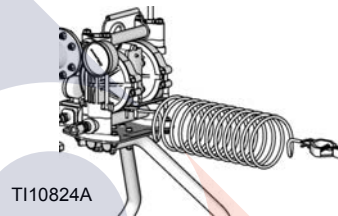

6. Connect the main air supply to the bleed-type air valve.

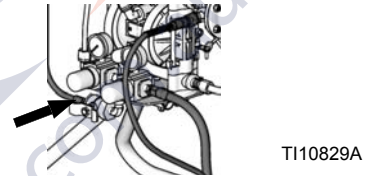

7. Flush. See **Flush**, page 9.

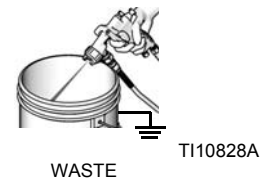
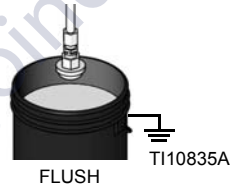

8. Prime. See **Prime**, page 10.

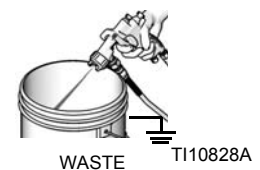
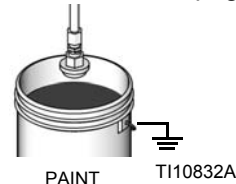

9. Spray. See **Spraying**, page 11.



# Setup/Installation



Before using the equipment for the first time, follow this procedure.

1. Connect the air hose to the gun air regulator.

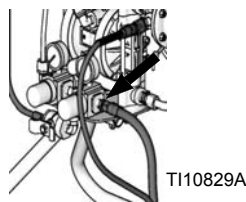

2. Connect the air hose to the gun.

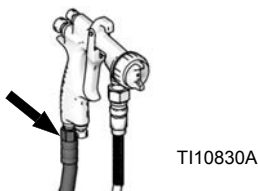



# Grounding

Read Fire and Explosion Hazard. See page 3.						

1. Connect the ground wire clamp to a true earth ground.

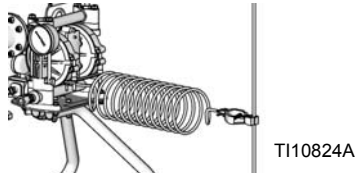

2. Ground the object being sprayed, fluid supply container, and all other equipment in the spray area.

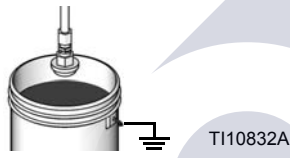

3. Ground all solvent pails. Use only metal pails. Do not place on a non-conductive surface such as paper or cardboard.

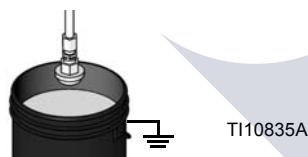

# Flush

1. Relieve pressure. See **Typical Installation**, page 7.
2. Remove the air cap. Clean separately.



3. Place the suction tube in solvent.

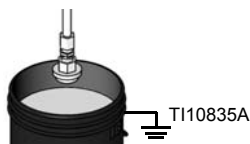

4. Turn off both air regulators.

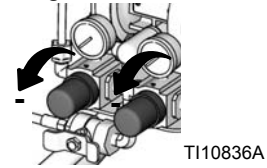

5. Open the bleed-type air valve.

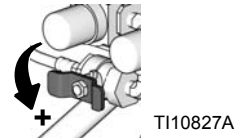

6. Open the pump air regulator until the pump starts.

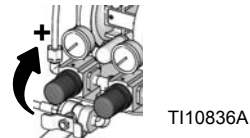

7. When clean solvent flows without air from the gun stop spraying.

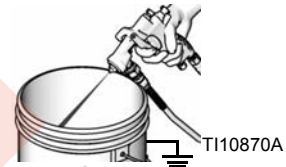

8. Remove the suction tube from the solvent. Continue to spray until all solvent is out of the gun.



9. Close the bleed type air valve.



10. Relieve pressure. See **Typical Installation**, page 7.

# Prime

1. Shut off both air regulators and the bleed-type air valve.

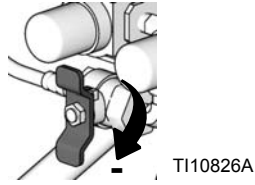
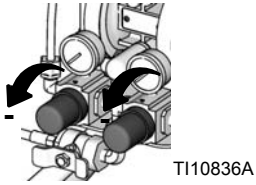

7. Adjust the fluid pressure regulator.

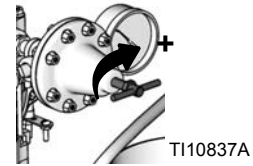

2. Shut off the fluid regulator.



8. Hold the gun firmly against a grounded metal pail and trigger the gun until fluid flow is steady. Release the trigger. The equipment is ready to spray.

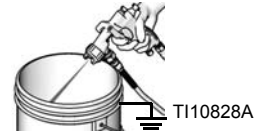

3. Install the air cap.

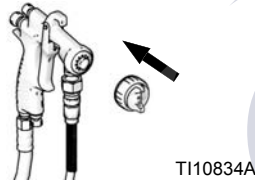

4. Place the suction tube in the fluid.

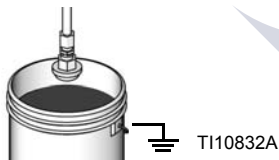

5. Open the bleed-type air valve.



6. Open the pump air regulator until the pump starts.

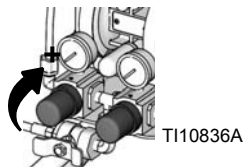

# Spraying

1. Adjust fluid flow using the pump air regulator or the fluid pressure regulator.

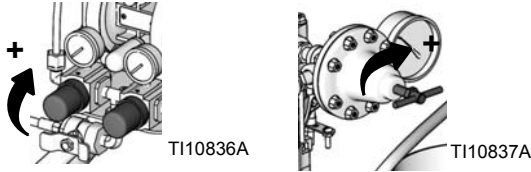

2. Adjust fluid pressure so stream from gun travels 6–8 in. straight before falling off.

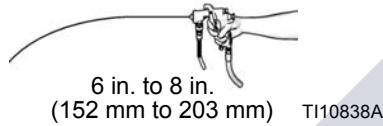

3. Adjust the gun air regulator to achieve proper spray gun atomization.

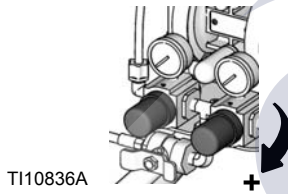

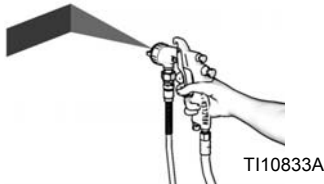
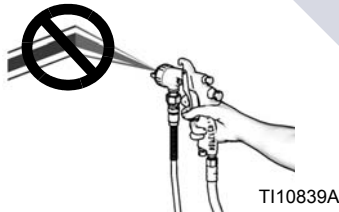

4. Test the spray pattern. Read the fluid manufacturer's recommendations. Adjust as necessary.



# Shutdown

1. Flush. See **Flush** page 9.
2. Relieve pressure. See **Typical Installation**, page 7.

# Maintenance

						
Relieve pressure before servicing. See <b>Typical Installation</b> , page 7.						

6. Clean the accessory air filter (not supplied) in your main air line.



1. Flush. See **Flush**, page 9.

2. Clean the air cap and fluid nozzle.



3. Clean the suction tube and inlet strainer, using a compatible solvent.



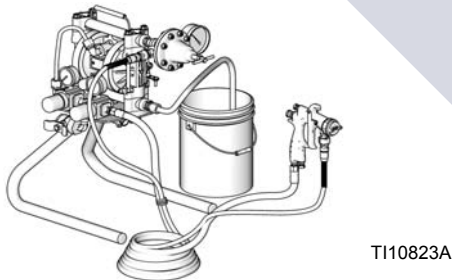

4. Clean the outside of the sprayer, using a soft cloth and compatible solvent.

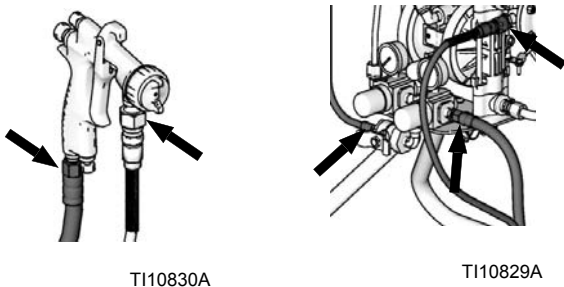

5. Check the hoses, tubes, and couplings every day. Tighten all fluid connections before each use.



# Troubleshooting

						
Relieve pressure before servicing. See <b>Typical Installation</b> , page 8.						

Problem	Cause	Solution
Pump will not run, or stops.	Air line valve shut off.	Open valve.
	Clogged fluid line or spray gun.	Clear, service. Do not allow fluid to setup in the pump and lines.
	Stuck or damaged pump air valve.	Service pump. Use filtered air.
Pump runs erratically.	Clogged suction line or inlet strainer.	Clear.
Pump runs too fast.	Exhausted fluid supply.	Refill fluid supply and prime sprayer.
Pump cycles at stall or fails to hold pressure at stall.	Worn check valves or o-rings.	Service pump.
Audible air leak.	Worn air valve.	Service pump.
Air bubbles in fluid.	Loose suction line.	Tighten. Use a compatible liquid thread sealant or PTFE tape on connections.
	Ruptured diaphragm.	Service pump.
Poor finish or irregular pattern.	Incorrect fluid or air pressure at gun.	See gun manual; read fluid manufacturer's recommendations. Use fluid regulator.
	Fluid is too thick or too thin.	Thin or thicken fluid; read fluid manufacturer's recommendations.
	Dirty, worn, or damaged spray gun.	Service gun.
	Fluid is settling out.	Order Part No. 245081 Agitator Kit.

# Parts

## 289353 with Finex Airspray Gun

## 289354 with Finex HVLP Gun

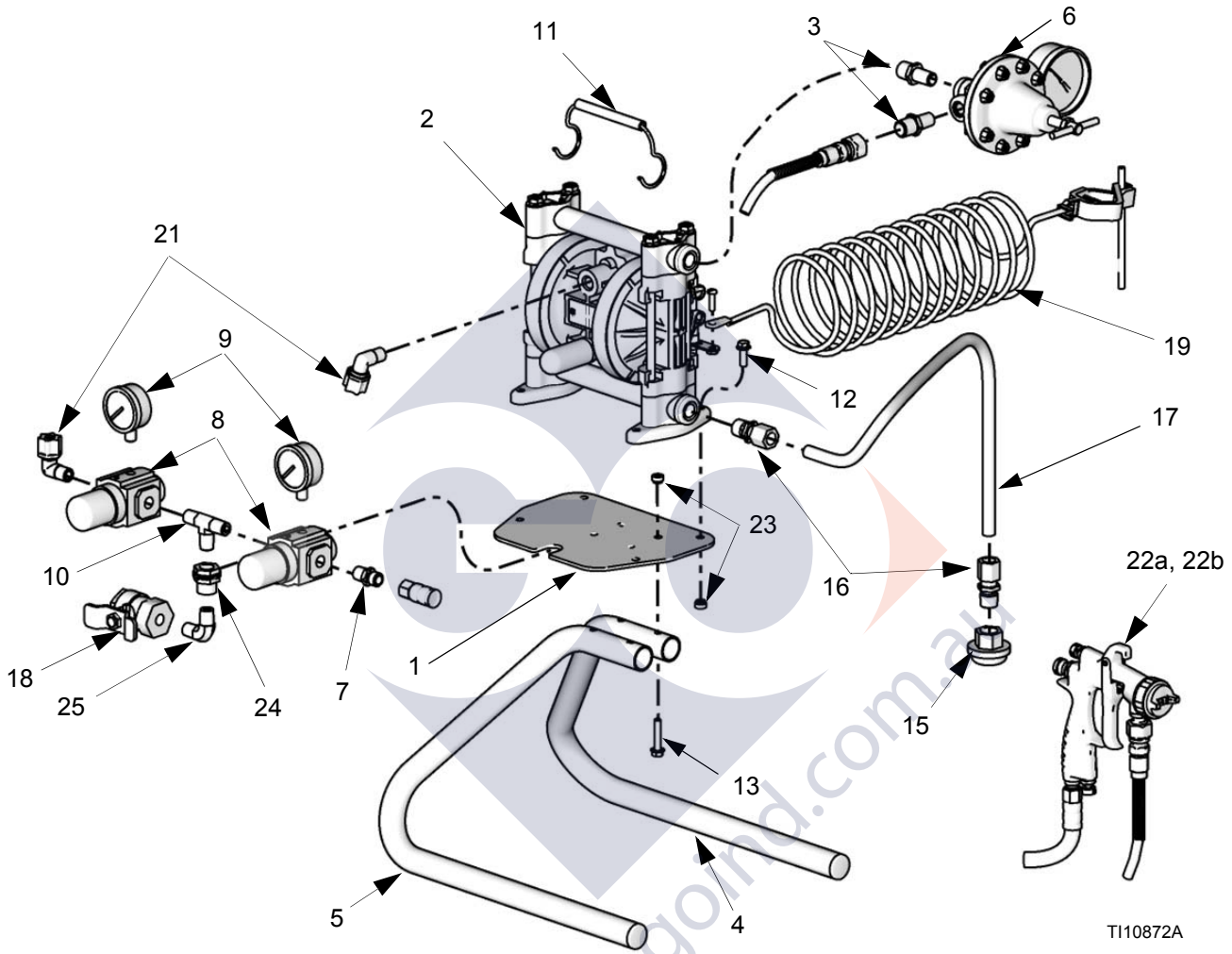

T110872A

Ref.	Part	Description	Qty.	Ref.	Part	Description	Qty.
1	289609	PLATE, mounting	1	17	590570	HOSE, polyethylene	4ft
2	D31331	PUMP, diaphragm	1	18	116473	VALVE, vented 2 way	1
3	164856	FITTING, nipple, reducing	2	19	237686	WIRE, ground assembly w/clamp	1
4	15D921	LEG, right, (finished)	1	20	289522	HOSE, set, bundled (not shown)	25ft
5	15D922	LEG, left, (finished)	1		240421	HOSE, set, bundled (not shown)	25ft
6	241976	REGULATOR, press, fluid	1				
7	162453	FITTING, 1/4 NPSM X 1/4 NPT	1	21	608780	FITTING, elbow male	2
8	116513	REGULATOR, air	2	22a	289254	GUN, GRACO Finex, conv, press	1
9	110436	GAUGE, pressure air	2	22b	289249	GUN, GRACO Finex HVLP	1
10	115219	FITTING, tee, 1/4 NPT	1	23	115942	NUT, lock hex	8
11	289610	HANDLE, wire pump	1	24	104641	FITTING, bulkhead	1
12	15R472	FASTENER, hex HD, flanged 1/4-2	4	25	111763	FITTING, elbow 1/4 NPT	1
13	114104	SCREW, mach, hex wash HD	4	26	513066	TUBE, 3/8" OD Nylon (not shown)	1ft
15	289608	STRAINER, suction line	1				
16	111864	CONNECTOR, male	2				

# Dimensions

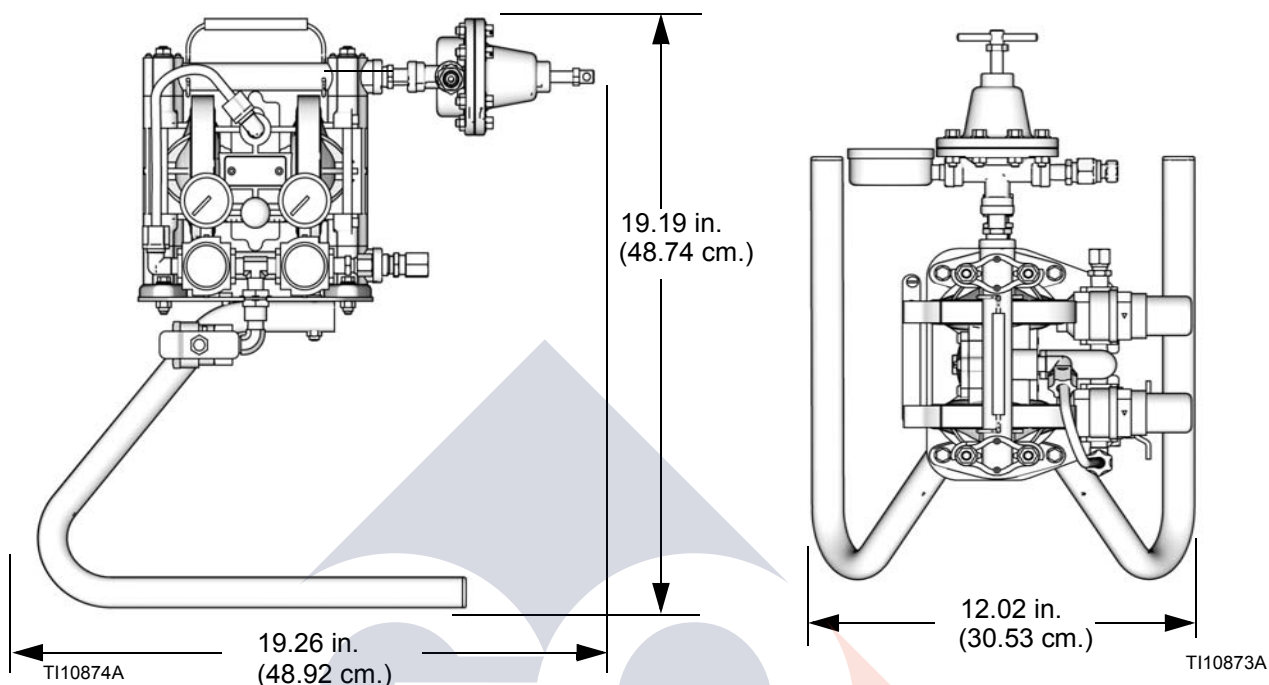

# Technical Data

Maximum fluid working pressure . . . . .	100 psi (0.7 MPa, 7 bar)
Maximum incoming air pressure . . . . .	100 psi (0.7 MPa, 7 bar)
Operating temperature range . . . . .	40 -109 F (4.4 - 43 C)
Package Weight . . . . .	19.8 lbs (9.0 kg)
Wetted Parts	
Pump . . . . .	see related manuals, page 2.
Gun. . . . .	see related manuals, page 2.
Fluid Regulator. . . . .	see related manuals, page 2.
Other. . . . .	nylon, acetal, SST, polyethylene

Sound levels: Refer to related pump and gun manuals. See page 2.

# Graco Standard Warranty

Graco warrants all equipment referenced in this document which is manufactured by Graco and bearing its name to be free from defects in material and workmanship on the date of sale to the original purchaser for use. With the exception of any special, extended, or limited warranty published by Graco, Graco will, for a period of twelve months from the date of sale, repair or replace any part of the equipment determined by Graco to be defective. This warranty applies only when the equipment is installed, operated and maintained in accordance with Graco's written recommendations.

This warranty does not cover, and Graco shall not be liable for general wear and tear, or any malfunction, damage or wear caused by faulty installation, misapplication, abrasion, corrosion, inadequate or improper maintenance, negligence, accident, tampering, or substitution of non-Graco component parts. Nor shall Graco be liable for malfunction, damage or wear caused by the incompatibility of Graco equipment with structures, accessories, equipment or materials not supplied by Graco, or the improper design, manufacture, installation, operation or maintenance of structures, accessories, equipment or materials not supplied by Graco.

This warranty is conditioned upon the prepaid return of the equipment claimed to be defective to an authorized Graco distributor for verification of the claimed defect. If the claimed defect is verified, Graco will repair or replace free of charge any defective parts. The equipment will be returned to the original purchaser transportation prepaid. If inspection of the equipment does not disclose any defect in material or workmanship, repairs will be made at a reasonable charge, which charges may include the costs of parts, labor, and transportation.

**THIS WARRANTY IS EXCLUSIVE, AND IS IN LIEU OF ANY OTHER WARRANTIES, EXPRESS OR IMPLIED, INCLUDING BUT NOT LIMITED TO WARRANTY OF MERCHANTABILITY OR WARRANTY OF FITNESS FOR A PARTICULAR PURPOSE.**

Graco's sole obligation and buyer's sole remedy for any breach of warranty shall be as set forth above. The buyer agrees that no other remedy (including, but not limited to, incidental or consequential damages for lost profits, lost sales, injury to person or property, or any other incidental or consequential loss) shall be available. Any action for breach of warranty must be brought within two (2) years of the date of sale.

**GRACO MAKES NO WARRANTY, AND DISCLAIMS ALL IMPLIED WARRANTIES OF MERCHANTABILITY AND FITNESS FOR A PARTICULAR PURPOSE, IN CONNECTION WITH ACCESSORIES, EQUIPMENT, MATERIALS OR COMPONENTS SOLD BUT NOT MANUFACTURED BY GRACO.** These items sold, but not manufactured by Graco (such as electric motors, switches, hose, etc.), are subject to the warranty, if any, of their manufacturer. Graco will provide purchaser with reasonable assistance in making any claim for breach of these warranties.

In no event will Graco be liable for indirect, incidental, special or consequential damages resulting from Graco supplying equipment hereunder, or the furnishing, performance, or use of any products or other goods sold hereto, whether due to a breach of contract, breach of warranty, the negligence of Graco, or otherwise.

## **FOR GRACO CANADA CUSTOMERS**

The Parties acknowledge that they have required that the present document, as well as all documents, notices and legal proceedings entered into, given or instituted pursuant hereto or relating directly or indirectly hereto, be drawn up in English. Les parties reconnaissent avoir convenu que la rédaction du présente document sera en Anglais, ainsi que tous documents, avis et procédures judiciaires exécutés, donnés ou intentés, à la suite de ou en rapport, directement ou indirectement, avec les procédures concernées.

## Graco Information

For the latest information about Graco products, visit [www.graco.com](http://www.graco.com).

**TO PLACE AN ORDER**, contact your Graco distributor or call to identify the nearest distributor.

**Phone:** 612-623-6921 **or Toll Free:** 1-800-328-0211 **Fax:** 612-378-3505

*All written and visual data contained in this document reflects the latest product information available at the time of publication.  
Graco reserves the right to make changes at any time without notice.*

*This manual contains English. MM 312473*

**Graco Headquarters:** Minneapolis  
**International Offices:** Belgium, China, Japan, Korea

**GRACO INC. P.O. BOX 1441 MINNEAPOLIS, MN 55440-1441**

Copyright 2007, Graco Inc. is registered to ISO 9001

[www.graco.com](http://www.graco.com)  
Revised 08/2009