

CUBE

**DISPENSERS
FOR PRIVATE USE**



USE AND MAINTENANCE MANUAL

ENGLISH

THE PERSONNEL WHO USE THE DISPENSER AND THE TECHNICAL SUPPORT PERSONNEL MUST BE FAMILIAR WITH THE FIRST AID AND SAFETY RULES DESCRIBED IN THIS MANUAL.

Keep this technical manual in a place that is familiar and accessible to all the personnel who have access to the dispenser.



TABLE OF CONTENTS

EC Declaration of conformity	4	<i>Meter accuracy</i>	8
First aid rules	5	Permitted uses	8
Persons who have ingested toxic liquids	5	Uses not permitted	8
Persons who have suffered electric shock ..	5		
General	5	C) Installation	9
Safety rules	5	<i>Packaging content</i>	9
Protective gloves	5	<i>Opening</i>	9
Permitted uses	5	<i>Reset knob</i>	9
Overheating	5	<i>Pulling out the tube support hook</i>	9
Smoking prohibited	5	<i>Installing the tube and nozzle</i>	9
Electrical precautions	5	<i>Installation general warnings</i>	9
Service	5	Mechanical installation	10
Transport, handling and unpacking	5	Hydraulic connections	10
Rules for demolition and disposal	6	<i>Maximum length of suction tubing</i>	10
Packing material disposal	6	<i>Recommendations and warnings</i>	10
Metal parts disposal	6	<i>Installation of the check valve and filter</i>	10
Miscellaneous parts disposal	6	<i>Connecting the tubing to CUBE</i>	10
A) Using and looking after manuals	6	Electrical connections	11
<i>List of manuals provided</i>	6	<i>Connecting the CUBE 230V ac single-phase</i>	11
B) General information	6	Starting	11
CUBE Dispenser	7	<i>Filling the pump</i>	11
<i>K33 meter</i>	7	<i>Priming the pump</i>	11
<i>Self-priming pump and motor</i>	7	<i>Calibrating the meter</i>	12
<i>Identification label</i>	7	<i>Turning on the Cube</i>	12
Components of CUBE dispensers	8	D) Instructions for use	13
Technical specifications	8	<i>How to dispense fuel</i>	13
<i>CUBE dispensers</i>	8	E) Maintenance	14
<i>K33 meter</i>	8	Opening and closing the CUBE	14
		Periodic inspections	14
		Cleaning the pump filter	14
		Troubleshooting	15
		Spare parts for the CUBE	16

EC DECLARATION OF CONFORMITY

The undersigned: **PIUSI S.p.A**
Via Pacinotti c.m. z.i.Rangavino
46029 Suzzara - Mantova - Italy

HEREBY STATES

under its own responsibility, that the equipment described below:

Description: **DIESEL FUEL DISPENSER**
Model: **CUBE 56 - CUBE 70**
Serial number: **refer to Lot Number shown on CE plate affixed to the product**
Year of manufacture: **refer to the year of production shown on the CE plate affixed to the product**

is in conformity with the legal provisions indicated in the directives:

- **Machine Directive 2006/42/EC**
- **Low-Voltage Directive 2006/95/EC**
- **Electromagnetic Compatibility Directive 2004/108/EC**

The documentation is at the disposal of the competent authority following motivated request at Piusi S.p.A. or following request sent to the email address: doc_tec@piusi.com

The person authorised to compile the technical file and draw up the declaration is Otto Varini as legal representative.

Suzzara 29/12/2009



the legal representative



Warning

The CUBE MC dispensing units described in this manual are for professional use only.

FIRST AID RULES

Persons who have ingested toxic liquids: whenever fuel has been swallowed, do not induce vomiting, but have the injured person drink large quantities of milk or water.



Persons who have suffered electric shock: disconnect the power source, or use a dry insulator to protect yourself while you move the injured person away from any electrical conductor.
Avoid touching the injured person with your bare hands until he is far away from any conductor
Immediately call for help from qualified and trained personnel.

IN ALL CASES, SEEK MEDICAL ATTENTION IMMEDIATELY**GENERAL**

CUBE dispensers are appliances designed for the private distribution of diesel fuel for motor transport. All the models of the series share the same sturdy metal structure and the self-priming type pumps, while they differ in terms of the meter - mechanical or electronic - and in the fact that some models feature an electronic dispensing Control System.

Reliability of pumping units, accurate measurement of dispensed product and high Control System performance are CUBE's strong points.

SAFETY RULES

Protective gloves. Prolonged contact with hydrocarbons can cause skin irritation: when dispensing fuel **always use PVC gloves** conforming to the standard EN 388 cat.2.



Permitted uses. The unit must always be used for the purpose intended. Follow the instructions listed in the chapter Instructions for Use.



Overheating. To prevent overheating, make sure that the pump of the dispenser stops whenever fuel has not been dispensed for more than 2 minutes.



Smoking prohibited. When operating the dispenser and in particular during refuelling, **do not smoke** and do not use open flame.



Electrical precautions. There are dangerously high voltages inside the unit. Only qualified and authorized technical personnel are allowed to open the dispenser.



Service. Service of the dispenser must be performed by qualified personnel.

TRANSPORT, HANDLING AND UNPACKING

CUBE is shipped inside stackable cardboard packaging.

DIMENSIONS OF PACKAGING: h. = 480mm / w. = 380mm / d. = 380mm

TOTAL WEIGHT: Cube 56/33 = 21.3 Kg Cube DC 12V = 22 Kg **PACKAGING WEIGHT:** 1.8 Kg
Cube 70/33 = 24.0 Kg Cube DC 24V = 22 Kg 1.8 Kg

When the machine is not used, whether it is packed or unpacked, it must be stored in a place protected from the weather (rain, damp, sun, etc.) and from dust.

To remove the cardboard packaging, use a pair of scissors or cutters, being careful not to damage the appliance. Fully open the packaging and take out the CUBE so that it can be taken to the place of final installation.

Once the packaging has been removed, the station must always be kept in vertical position.

Packaging parts (cardboard, wood, cellophane, etc...) must be placed in specific containers and not left lying around or within reach of children, as these represent a potential risk hazard. They must be disposed of according to the regulations applicable in the country of use.

Check the integrity of the machine by making sure the shipped parts are not damaged in any way that could affect safety and operation. In case of any doubts, do not start the appliance but contact the manufacturer's after-sales service.

RULES FOR DEMOLITION AND DISPOSAL

The components must be given to companies that specialise in the disposal and recycling of industrial waste and, in particular, the

DISPOSAL OF PACKAGING:

The packaging consists of biodegradable cardboard which can be delivered to companies for normal recycling of cellulose.

DISPOSAL OF METAL COMPONENTS:

The metal components, both painted and stainless steel, are usually recycled by companies that are specialised in the metal-scraping industry.

DISPOSAL OF ELECTRIC AND ELECTRONIC COMPONENTS:

these have to be disposed by companies that are specialised in the disposal of electronic components, in accordance with the instructions of 2002/96/EC (see text of Directive below).

DISPOSAL OF OTHER PARTS:

The disposal of other parts such as pipes, rubber seals, plastic components and cables should be entrusted to companies that specialise in the disposal of industrial waste.

ENVIRONMENTAL INFORMATION FOR CUSTOMERS IN THE EUROPEAN UNION



European Directive 2002/96/EC requires that the equipment bearing this symbol on the product and/or its packaging must not be disposed of with unsorted municipal waste. The symbol indicates that this product should be disposed of separately from regular household waste streams. It is your responsibility to dispose of this and other electric and electronic equipment via designated collection facilities appointed by the government or local authorities.

A USING AND LOOKING AFTER MANUALS

This CUBE manual shows the main features of the various models and provides details of:

- electrical and mechanical installation.
- first start up operations.
- daily use.

This collection of manuals represents an integral and essential part of the product and, according to the provisions of directive EEC 89/392, **must be given to operators and maintenance staff** in order to comply with the obligations relating to training/information referred to in directive EEC 89/391. **Carefully read the instructions contained in these manuals**, as these are most important for installation safety, operation and maintenance. **The manufacturer disclaims all liability for injury to persons or damage to things, or the machine, in the event of this being used in a way different to that indicated in the instructions.**

This manual DOES NOT cover other aspects such as:

- calibration of the K33 meter.

For these aspects, refer to the specific manuals which accompany each station model.

Look after this manual carefully in a place protected from damp, heat, dust, oils, greases, etc., as it will be useful for future reference and consultation. Do not remove, tear or amend any parts of the manual for any reason. In case of loss or damage, ask the manufacturer for a copy, quoting the manual code.

This manual must always remain with the machine; in the event of the machine being sold, it must be given to the new user.

The company reserves the right to change CUBE features and specifications at any time.

List of manuals provided

M0042	Panther 56 / 72 Manual
M0033	Meter K33 / K44 Manual
M0127	Panther DC Manual

B GENERAL INFORMATION

CUBE dispensers are designed for the transfer of diesel fuel for private use. Characterised by maximum safety and simplicity of use, CUBE dispensers are dependable, high-performance equipment that is quickly installed and ready for use.

Equipment and features are:

- Self-priming rotary vane pump with incorporated by-pass valve.
- Motor with protection grade IP55 and thermal protection, 230V AC single-phase.
- Brush motor powered by continuous current, low voltage, with intermittent cycle, closed type, IP55 protection class according to CEI

- EN 60034-5, flange-mounted directly to the pump body (version Panther Dc).
- Four meters of anti-static rubber tube for fuel.
- Automatic type dispensing nozzle with on-off switch integrated into the nozzle rest.
- Steel body with anti-corrosion treatment and paint finish.
- 110/120 V AC-60 Hz motor on request.

CUBE dispenser

The CUBE dispenser is equipped with a Series K mechanical type meter.

K33 meter

Series K meters are mechanical oscillating disk meters designed to allow the precise measurement of diesel fuel. The meter is provided with a non-resettable counter in litres and a partial resettable indicator:

- the partial indicator has three digits and the total indicator has six digits.
- For additional information, consult Technical Bulletin M 0033 "Mechanical Meters, Use and Maintenance."

Self-priming pump and motor

CUBE dispensers are equipped with self-priming, volumetric, electric rotary vane pumps for the transfer of diesel fuel, provided with a by-pass valve. Such a valve allows functioning for brief periods of time even with the dispensing nozzle closed. The

motor which is directly coupled to the pump body is asynchronous, closed-type self-ventilated, AC single-phase. For additional information and technical data, consult Technical Bulletin M0042 "PANTHER 56/72".

Nozzle

The nozzle supplied with CUBE is of automatic type and fitted with a shut-off device for full tank.

Identification label



MANUFACTURER	PIUSI	CUBE 56/33	PRODUCT NAME
	PIUSI S.P.A. SUZZARA (MN) ITALY	CODE 00057500C	PRODUCT CODE
	CERTIFIED COMPANY UNI-EN ISO 9001	230 V Qmax 56 l/min 50 Hz Pmax 3 bar 2.2 A < 75 db 370 W S1 2800 rpm cos Ø 0,92 IP55 Cond. 12,5 µF	TECHNICAL SPECIFICATIONS
LOT NUMBER	00000000	YEAR 2003	PRODUCTION YEAR
	Read instruction M0097 ML	CE	CE MARK

The label is attached to the left side of the dispenser.

! WARNING
Before installing, always make sure the dispenser model is correct and suitable for the available power supply (voltage/frequency)

Components of CUBE dispensers

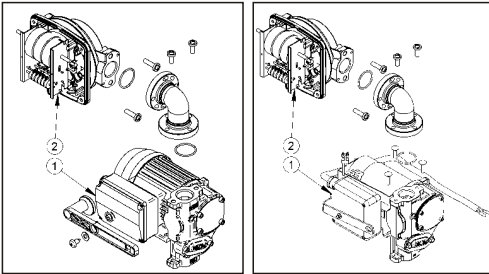

The pictures aside show the CUBE components. In particular, those components that distinguish the various models of the CUBE product line are numbered and described.

Drawing Ref. Description

- 1** Pump-Motor Unit
- 2** Meter

Technical specifications

CUBE dispensers MODEL	Supply voltage	Absorption (A)	Power (W)	Flow rate (l/m)
CUBE 56 / 33 > 230/50	230 V / 50 Hz - 1~	2.4	370	55
CUBE 56 / 33 > 230/60	230 V / 60 Hz - 1~	3.3	520	62
CUBE 56 / 33 > 110/60	110 V / 60 Hz - 1~	8.25	250	62
CUBE 56 / 33 > 110/50	110 V / 50 Hz - 1~	6	250	55
CUBE 70 / 33 > 230/50	230 V / 50 Hz - 1~	3.3	500	72

K33 - K44 meter

Partial meter indicator
Main total indicator

3-digit resettable
6-digit non-resettable

Meter accuracy

The K 33-K44 meters, after correct calibration in the field, provide the following performances:
ACCURACY: +/- 1% (after calibration, for flow rates of over 10 l/min)

Permitted uses

Transfer of diesel fuel with a viscosity from 2 to 5.35 cSt at 37.8°C and PM flash point >55°C.

Uses not permitted

The transfer of fluids with different characteristics than those indicated above is not allowed. In particular:

Fluids not permitted

- Petrol
- Inflammable liquids with PM < 55°C
- Water
- Food liquids
- Liquids with viscosity >20 cSt
- Corrosive chemical products
- Solvents

Related danger:

- Fire/explosion
- Fire/explosion
- Pump oxidation
- Contamination of the same
- Motor overload
- Pump corrosion
- Injury to persons
- Fire/explosion
- Damage to gasket seals

C INSTALLATION

Packaging content

- 1 Cube
- 2 Valve/filter kit
- 3 Nozzle
- * Tube

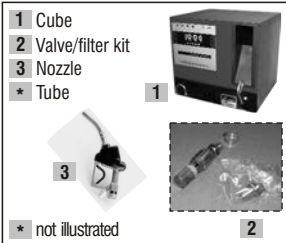

1

3

* not illustrated

2

Opening

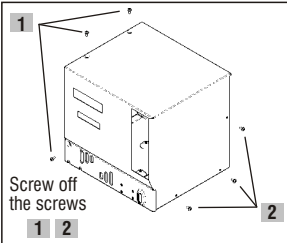

1

2

Screw off the screws

1 2

Reset knob

Put the knob on the guide and push thoroughly



Pulling out the tube support hook

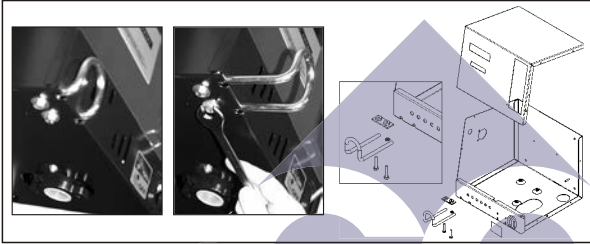

Installing the tube and nozzle

use a suitable dope for the threads

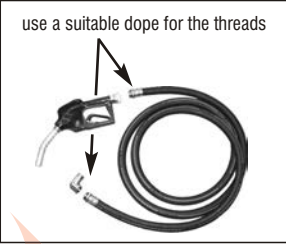

Installation general warnings

The CUBE dispenser can be installed outside. Nevertheless, it is advisable to locate it under the shelter of a roof to ensure the dispenser's longevity and provide greater comfort during refuelling in the event of bad weather. The installation of the dispenser must be carried out by skilled personnel and performed according to the instructions provided in this chapter.

The maximum length of the tubing must conform to the "Recommendations and Warnings" provided on the following page.

Minimum tube diameter: 1"

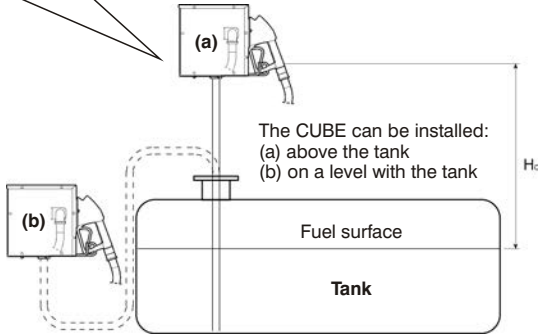

The **H_o** difference in height between the fuel surface and the pump in the dispenser must not be higher than 3 m!

Fig. 2.1 - Dispensing system installation diagram

Mechanical installation

Before beginning the installation, verify that no packing material has been trapped in the tubing.

Prepare suitable stilts or fixing brackets

depending on the fixing position of the CUBE. The tube coming from the tank must be aligned to the threaded inlet of the pump filter which is located under the CUBE.

Hydraulic connections

Warning. Remove the protective caps from the threads. The hydraulic connections can be made with flexible or rigid tubes with adequate joints, as

long as they are done by skilled personnel, in a workmanlike manner, with respect for the regulations in effect in the country of installation.

Maximum length of suction tubing

The maximum length of the tubing, the diameter of the tubing, the difference in height, are parameters that are tightly linked to creating suction conditions. The latter must not be such as to create backpressure greater than 0.6 bar. It follows as a consequence that, after respecting the minimum diameter of the tubing specified in

the *Recommendations and Warnings* below, the length of the tubing decreases as the difference in height that the diesel fuel must overcome increases and vice versa: in fact, the back pressure progressively increases by 0.08 bar for every meter increase in the static height of the pump with respect to the level of the diesel fuel in the tank.

! Recommendations and warnings

- The suction tubing must resist a pressure of at least 10 bar and must be of a diameter NOT LOWER than 1".
- The tubing must be suitable to functioning under backpressure.
- Use tubing and accessories suitable for use with diesel fuel. Materials that are not suitable for use with diesel fuel can cause damage to the pump, harm people and cause pollution!
- Any curves in the suction tubes must be of the widest radius possible to limit the loss of head.
- Make sure that the suction tubing is clean and free of scum.

Installation of the check valve and filter

At the intake end of the tube, a check valve and a suction filter must be attached that must remain immersed at the bottom of the tank. The check valve and the filter are provided as part of the equipment with the CUBE dispenser.

SUGGESTION: Before connecting the tubing to the pump filter it is a good idea to fill the tubing with diesel fuel to facilitate priming the pump during the phase of putting it into operation.

Fig. 2.2 - Check valve and filter installation

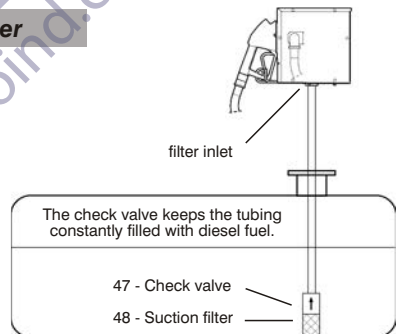

Connecting the tubing to CUBE

Screw the other end of the tubing to the pump filter.

! WARNING

Do not use conical threaded connectors that could cause damage to the threaded connector on the pump filter.

Electrical Connections

The electrical connections must be performed in a workmanlike manner by skilled personnel, respecting the regulations in effect in the country of installation.

The maximum acceptable variations from the electrical parameters are:

- voltage $\pm 5\%$.
- frequency $\pm 2\%$

Connecting the CUBE 230V ac single-phase



Simply introduce the cable with the Schuko plug into the hole at the bottom of the CUBE (see picture aside) and connect the plug to a grounded outlet of the household type.

Connect the ground wire to a grounding connection prepared according to the regulations.



WARNING

CUBE dispensers are not equipped with circuit breakers. It is therefore strongly recommended to install on the plug a 30-mA residual current operated circuit breaker.

Connecting the c.c. DC CUBE

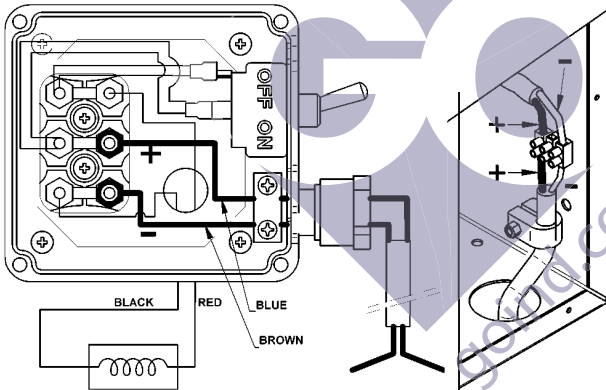

WARNING

Connect the power cord following the polarity: **blue = + / brown = -** and lock it as shown in the drawing.

Refer to Panther DC (M0127) manual for information concerning the fuses (30A for the 24V version and 40A for the 12V version).

The direction of the selector should be as shown in the picture

Starting

Filling the pump

The pump provided with the CUBE is a self-priming pump capable of suctioning an empty tube, nevertheless, the pump should be partially filled with diesel fuel before

turning it on for the first time.

It is left to the technician's experience to determine the best way to fill the pump.

Priming the pump

It is advisable to oversee the first priming phase to make sure that it is happening in a reasonable amount of time: depending on the length and fill status of the

priming tubes, the priming of the pump can require from several seconds to several minutes, as a function of the characteristics of the system.

⚠ Recommendations and warnings

If this phase is excessively prolonged, stop the pump and verify that:

- the pump is not running completely dry;
- the suction tubing is air-tight and completely immersed in the fluid to be pumped;
- the suction filter is not clogged;
- the difference in height for priming is not greater than 3 meters;
- the residual air in the tubes has been evacuated.

Calibrating the meter

Before using the CUBE station, check the METER ACCURACY.

For this purpose, proceed as follows:

- Take out the nozzle and start the pump as described in the above paragraph.
- Run the fuel into a calibrated container.

⚠ Recommendations and warnings

- To correctly check accuracy, always keep to the following instructions:
- Use a precision sample container, featuring a graduated measuring scale, with a capacity of at least 20 litres.
- Before making the check, always make sure you have eliminated all the air from the system and then run the fuel until a full and regular flow is achieved.
- Dispense in a continuous way at maximum CUBE flow rate.
- Stop the flow by quickly closing the nozzle.
- Reach the graduated area of the container, avoiding prolonged dispensing at low flow rates; prefer short dispensing operations at maximum flow rate.
- Compare the reading provided by the container, with that provided by CUBE, after waiting for all the froth to disappear.

If accuracy is **NOT** satisfactory, proceed to **CALIBRATE THE METER** according to the instructions in the M0033 manual.

⚠ WARNING

Differences up to 0.2 litres out of every 20 litres fall within the guaranteed accuracy of +/- 1%.

Turning on the Cube

For all CUBE versions it is sufficient to:

- take the dispensing nozzle away from the rest;
- Lift the rest (ON) (Fig. 2.5).

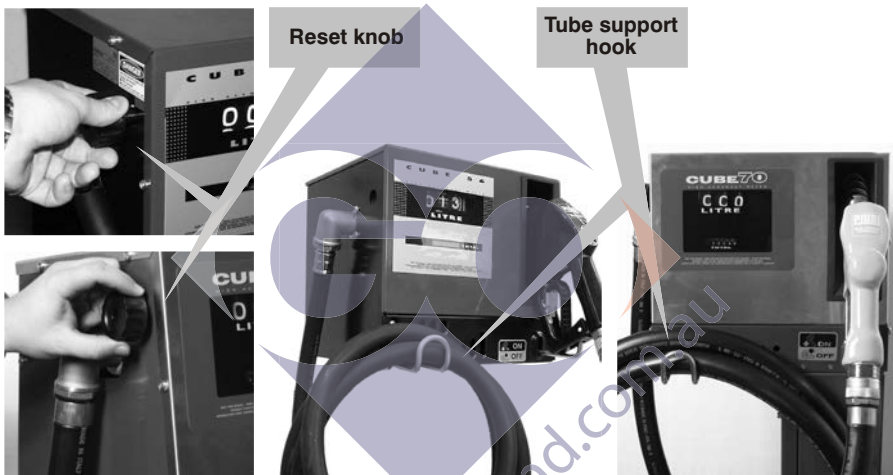

Fig. 2.5 - Turning on the Cube

D INSTRUCTIONS FOR USE**⚠ Recommendations and warnings**

- Transfer of fuel must always occur in the presence and under the control of the Operator.
- Keep the dispensing nozzle closed until it is inserted in the container to be filled.
- If the nozzle lever is not completely pressed, the automatic release device will not work.

The functions and instructions for use of the relative manual M 0033. K33 mechanical meter are described in the

How to dispense fuel

- 1) Rotate the reset knob in a counter-clockwise direction to completely zero-out the partial indicator. The total indicator cannot be reset to zero.
- 2) Extract the dispensing nozzle (a) and insert it in the container to be filled.
- 3) Set the starting handle to position ON (b): the pump starts.
- 4) Press the nozzle lever and keep it pressed until you have dispensed the desired quantity.
- 5) When dispensing is finished, set the start handle to OFF (c): the pump stops. Replace the nozzle (d).
- 6) Rehang the tube on the tube support hook, so that it will not be crushed by moving vehicles.

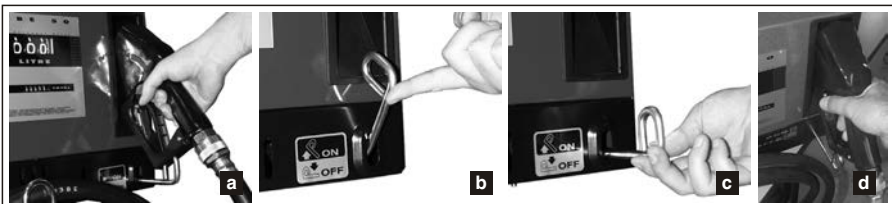

E MAINTENANCE

Opening and Closing the CUBE

- Screw off and remove the three cross-head screws on the left side of the CUBE (Fig. 4.1, screws A).
- Screw off and remove the three cross-head screws on the right side of the CUBE (Fig. 4.1, screws B).
- Raise the CUBE higher part.
- To reclose it, perform these steps in reverse order.

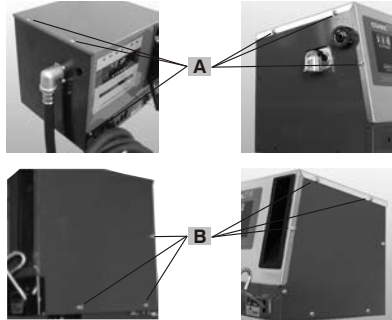

Fig. 4.1 - Opening the CUBE

Periodic Inspections

- Check weekly and keep the pump body, tubing and flanges clean to promptly reveal any leaks.
- Keep the dispensing nozzle tube clean and especially the hole for the excess pressure probe at the end of the nozzle tube (Fig. 4.2).
- With equal frequency or at least every time the tank is filled, clean the filter and check valve at the bottom of the tank.
- Every three months (or more often in case of doubt) verify the accuracy of the meter.

Probe hole



Fig. 4.2 - Nozzle tube and probe

Cleaning the pump filter

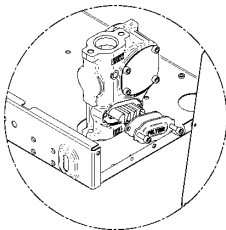

The pump filter must be cleaned weekly or more often whenever a reduction in flow rate is noticed. The frequency required depends most of all on the quantity of fuel dispensed, but also on other causes as well, such as dispensing fuel immediately after refilling the tank, which stirs up sediment which normally lies at the bottom.

To gain access to the filter:

- Remove the upper part of the Cube (and the side part for the version CUBE 70), by unscrewing the 6 side screws (see *Opening and Closing the Cube*)
- Screw off the 2 screws on the filter cover.
- To clean it, it is sufficient to wash it and blow through it.

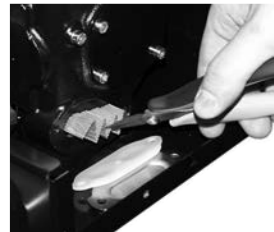

Troubleshooting

Problem	Possible Causes	Possible Solutions
Motor not turning	Lack of electric power	Set the starting handle to position ON. Reset the external residual current circuit-breaker. Check the electrical connections.
	Fuses burned out	Replace the fuses in the electric panel
	Faulty switch on the electric panel	Change the switch
	Motor Problems	If the rotor is jammed, dismount and check for damage and obstructions, then remount. Contact the Service Department
Motor won't start with nozzle closed	Electric voltage too low	Check that the voltage is not more than 5% below the nominal voltage
Low or no flow rate	Excessive suction pressure	Lower the CUBE with respect to the tank or increase the diameter of the tubing
	High loss of head	Use shorter tubing or of greater diameter
	Suction tube resting on the bottom of the tank	Raise the suction tube
	Low level in the suction tank	Refill the tank
	Air entering the suction tube or in the pump	Check the connections seal in the tubing and the level of diesel fuel in the tank
	Motor low rotation speed	Check the voltage at the motor. Adjust the voltage and/or use cables of greater cross-section
	Check valve blocked	Clean or replace
	Tank filter clogged	Clean the filter
	Pump filter clogged	Clean the filter
	Fluid leaking	Check the seal of the connections and the condition of the rubber tubes
	Meter chamber obstructed	Clean the meter chamber
Meter accuracy not sufficient	Air in the suction line	Check the seals of the connections
	Measuring chamber dirty	Clean the meter measuring chamber

Spare parts for the CUBE

**CUBE
70**

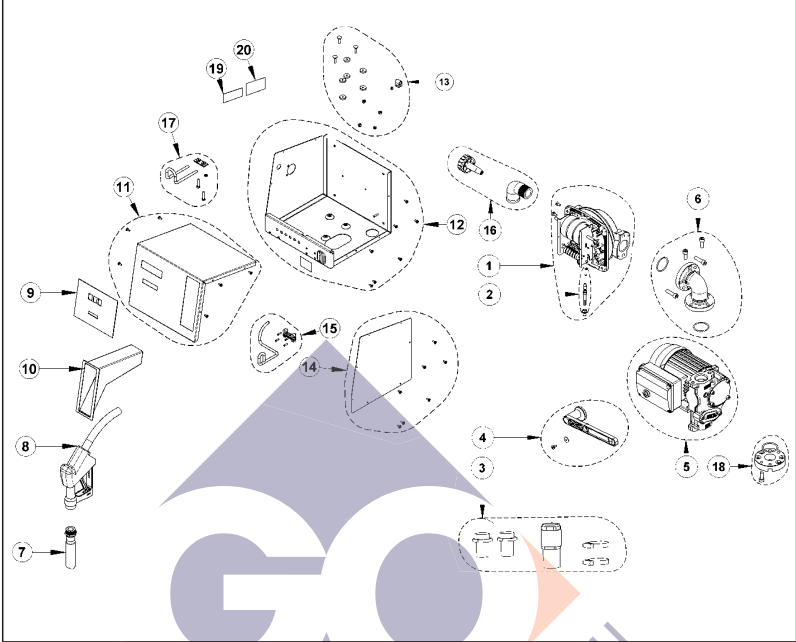

**CUBE
DC-56**

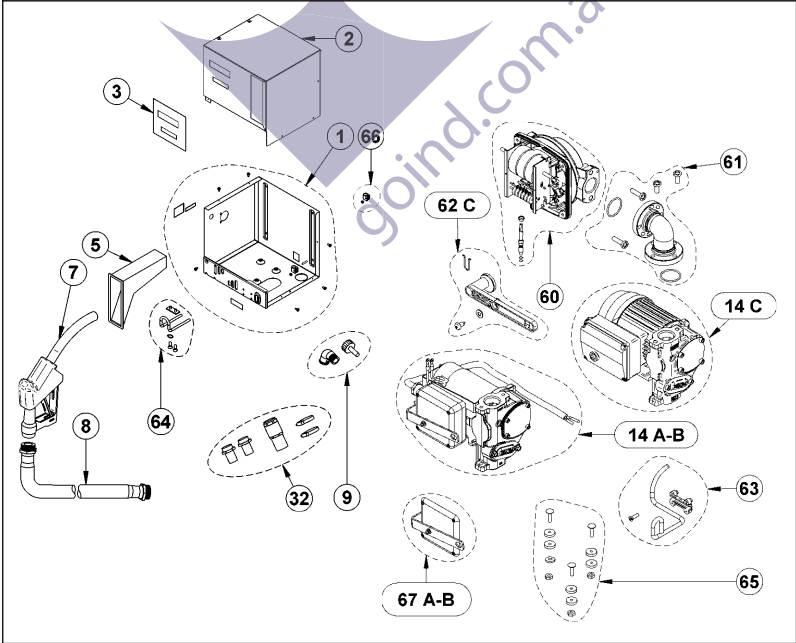

MANUFACTURER: **PIUSI S.p.A.**

DOCUMENT TYPE: **General description and instructions
for its installation, activation,
use and maintenance**

EDITION: **Bullettin M0097C Rev.1**

PRODUCT: **Diesel fuel dispenser for private use
with meter**

MODEL: **All of the models of the CUBE product line,
with mechanical/electrical meters,
single-phase/three-phase in various
voltage/frequency combinations**

CONFORMITY: **CE Marked
(see Declaration of conformity, page 4)**

TECHNICAL SUPPORT: **Provided by the service departments
of our authorized resellers**



The information contained in this manual is provided by the Manufacturer, who reserves the right to make changes without prior notice.

NOTES



NOTES



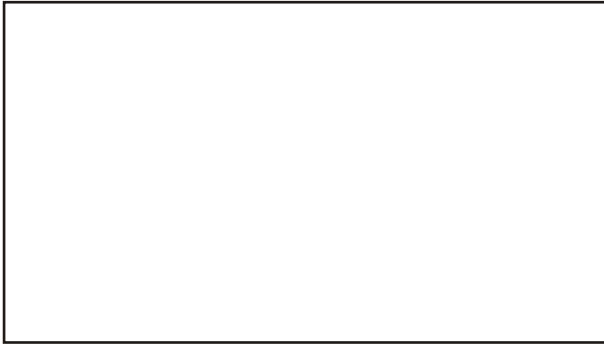

Authorized reseller's stamp



PIUSI
®

M0097C EN - Rev.1