

Tank	
Content	Diesel
External size	2991x2438x2896mm
Internal size	2919x2374x2690mm
Total volume	18,053L
Safe volume	16,250L

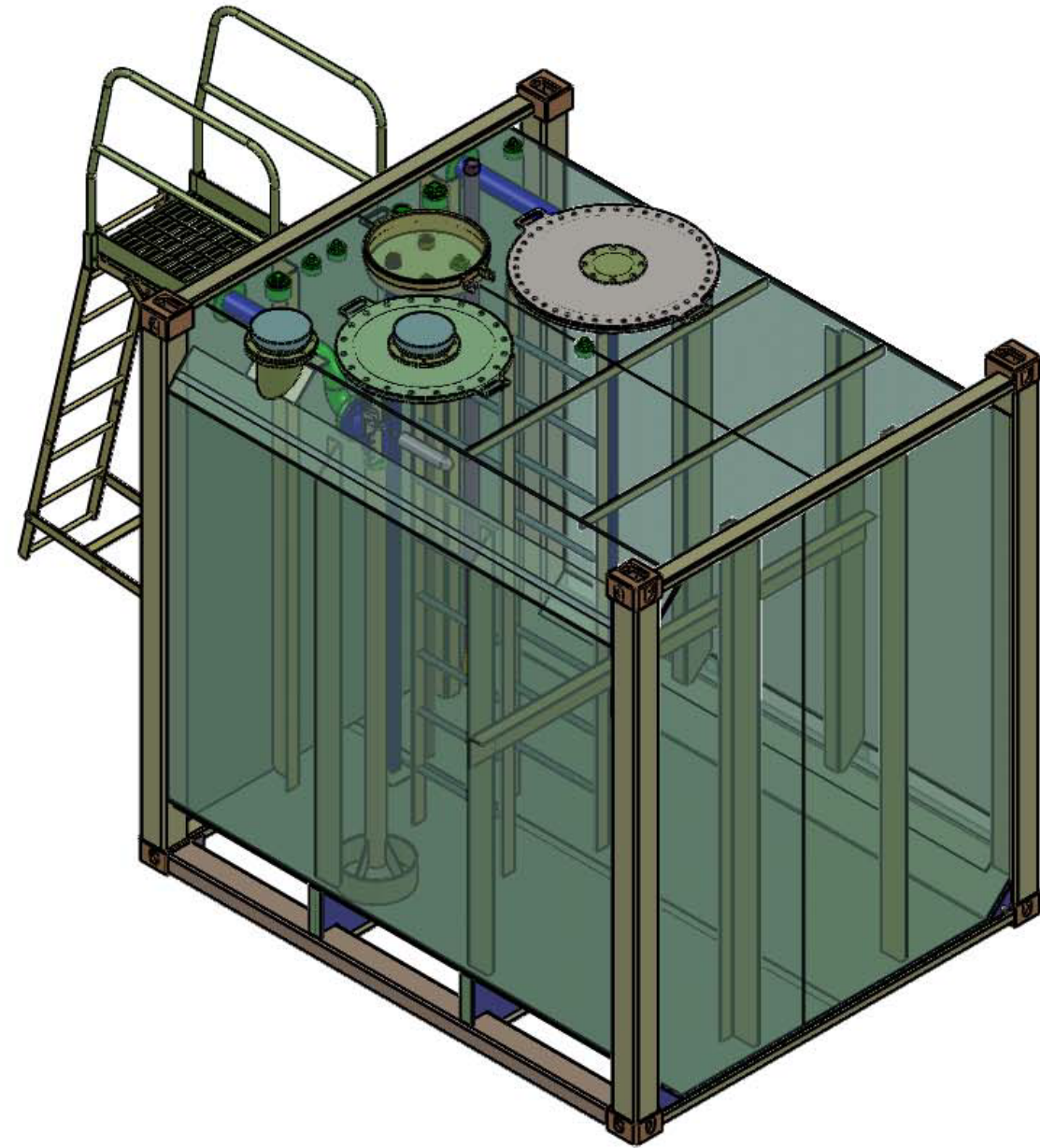

07					
06					
05					
04					
03					
02					
01					
REV:	DATE:	REVISION:	DRAWN:	CHECKED:	APPROVED:

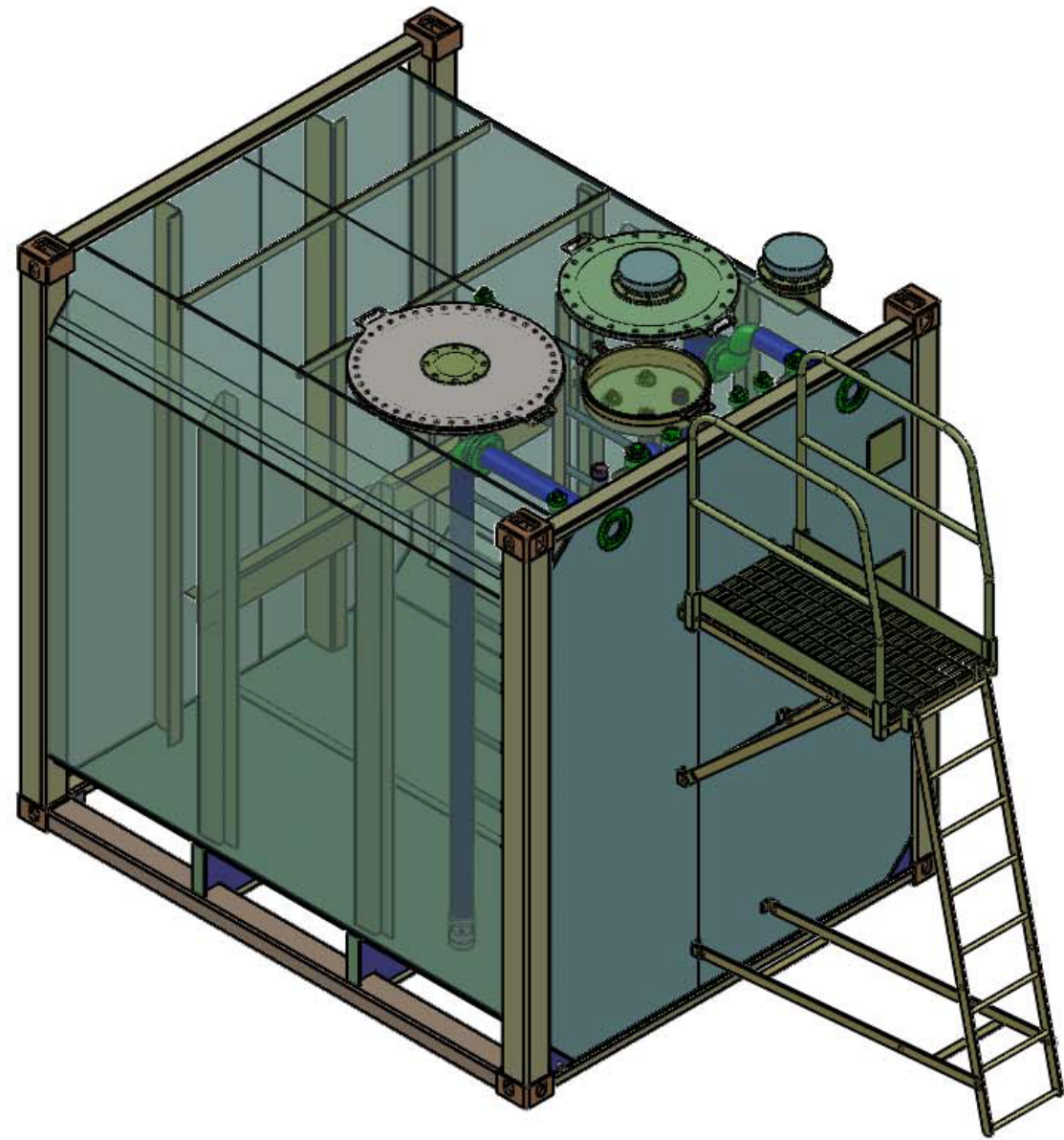

Material:
Weight: 4779.48KG

DRAWN: SAVING DATE:
CHECKED: DATE:
CLIENT: DATE:
APPROVED: DATE:

TITLE:
CON-18 SELF BUNDED TANK
DRAWING NO. :
PURCHASE ORDER NO. :

REV:
SHEET:
1 of 7
Scale:
No scale

A3



12 11 10 9 8 7 6 5 4 3 2 1

H
G
F
E
D
C
B
A

DO NOT SCALE-IF IN DOUBT ASK

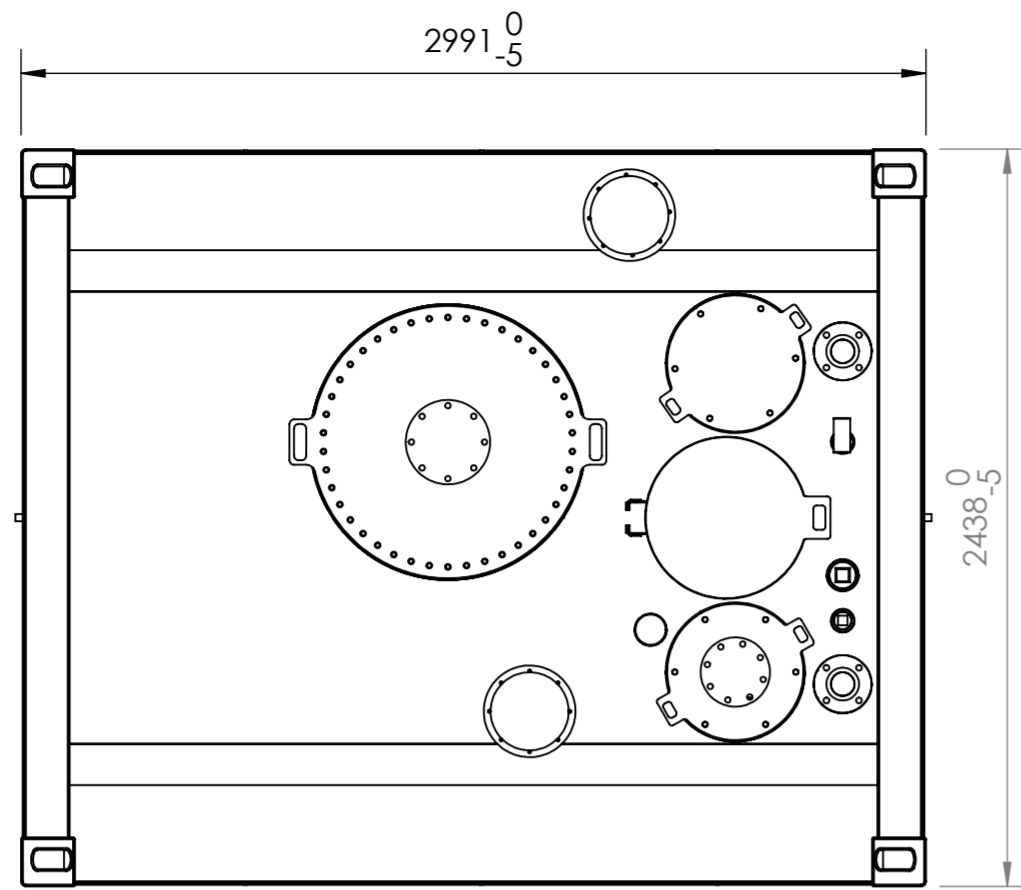

TANK DATA	
DESIGNED TO:	AS1692, AS1940, UL142, ULC S601, CSC
BUILT TO:	AS1692, UL142, ULC S601, CSC
TESTED TO:	UL142, CSC
OUTER / INNER WALL THICKNESS:	5mm / 5mm
GROSS VOLUME:	18 010L; 4 758 US gal
SAFE FILL LEVEL (VOLUME):	17 100L; 4 517 US gal (95%)
LEAK TEST PRESSURE:	21-35 kPa; 3-5 psi
PAINT SPECIFICATION:	HEMPEL PAINT 1st: HEMPADUR ZINC 17360: 50 µm 2nd: HEMPADUR FAST DRY 15560: 100 µm 3rd: HEMPATANE HS 55610: 50 µm COLOUR: HEMPEL 10000 - GLOSSY WHITE
TOTAL MASS (EMPTY):	3 760 kg

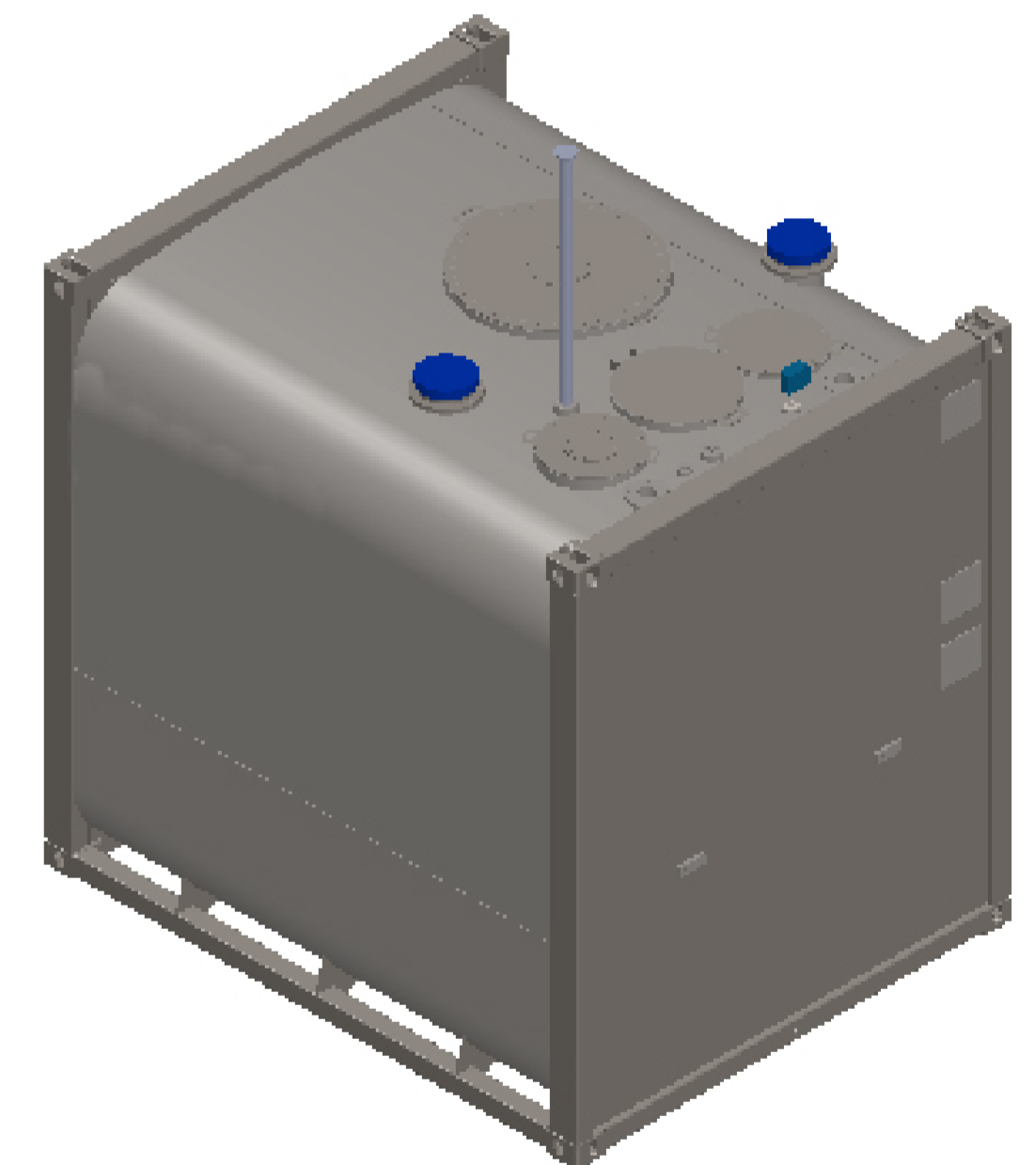
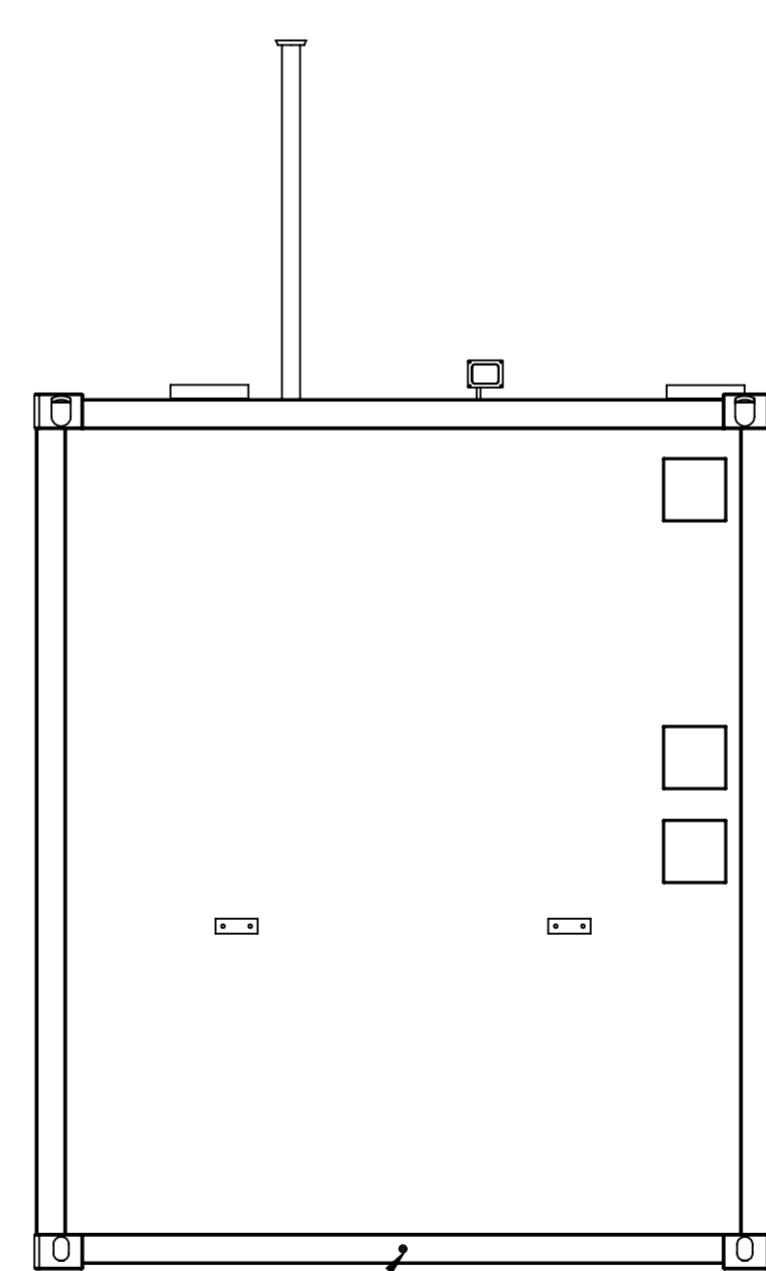
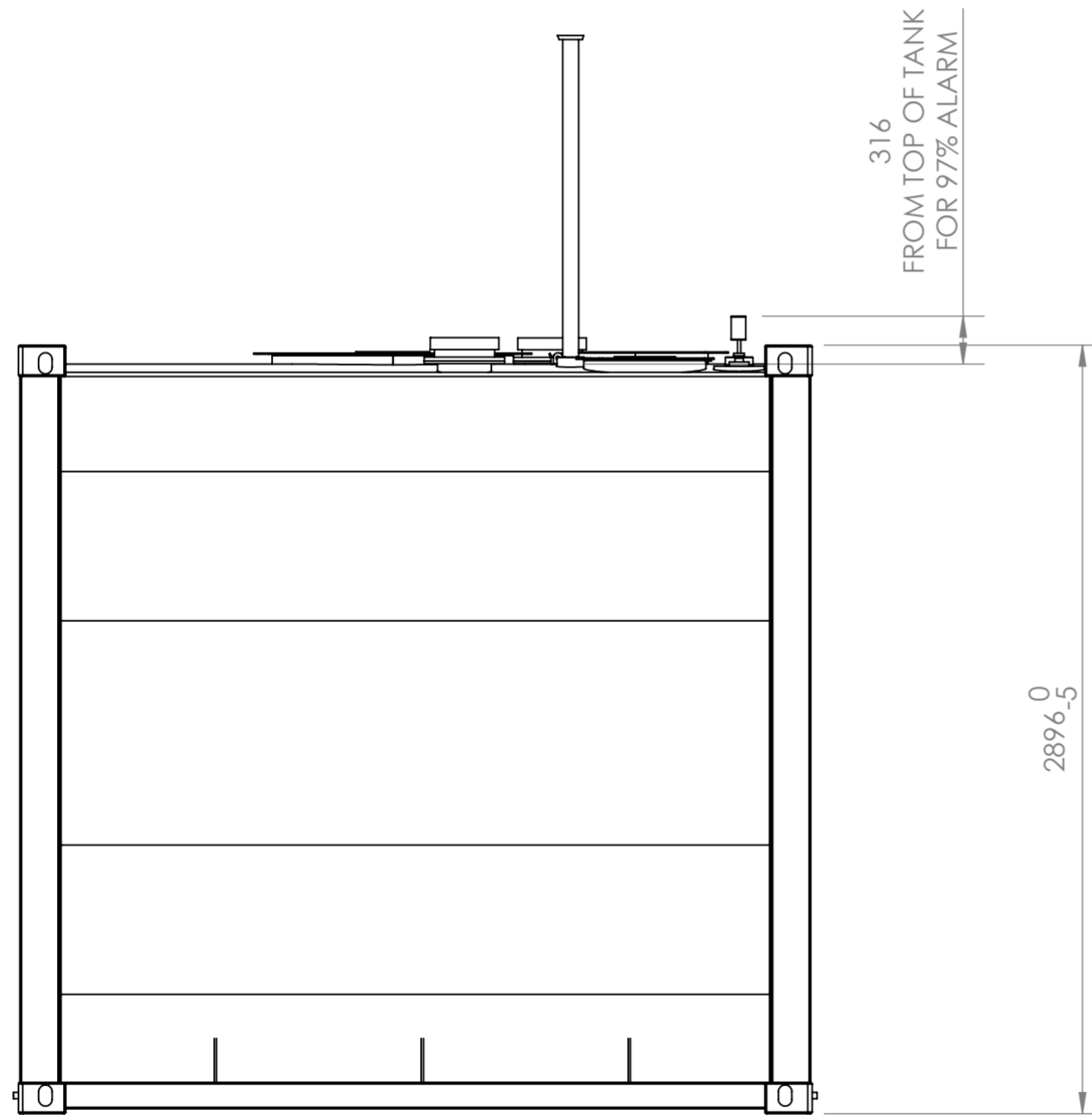

IF IN DOUBT ASK. DRAWING INFORMATION TAKES PRECEDENCE OVER PARTS LIST

0	For Information	06/04/2020	MB	BL	NO
REV.	DESCRIPTION	DATE	DWN	CHK	APP
REVISIONS					



GENERAL NOTES		
DO NOT SCALE UNLESS STATED OTHERWISE. ALL DIMENSIONS IN MILLIMETERS. ALL THREADS ARE METRIC COARSE. DEBURR & REMOVE ALL SHARP EDGES.		
TOLERANCES:	RANGE	TOLERANCE
LINEAR (mm)	0-100	±0.5
	101-1000	±2.0
	>1000	±5.0
ANGULAR (°)		±0.5

TITLE		SHEET 1 OF 2		REV
CON-18 General Arrangement Standard Configuration		DRAWING NUMBER	SCALE	A
		NTS		A

12 11 10 9 8 7 6 5 4 3 2 1

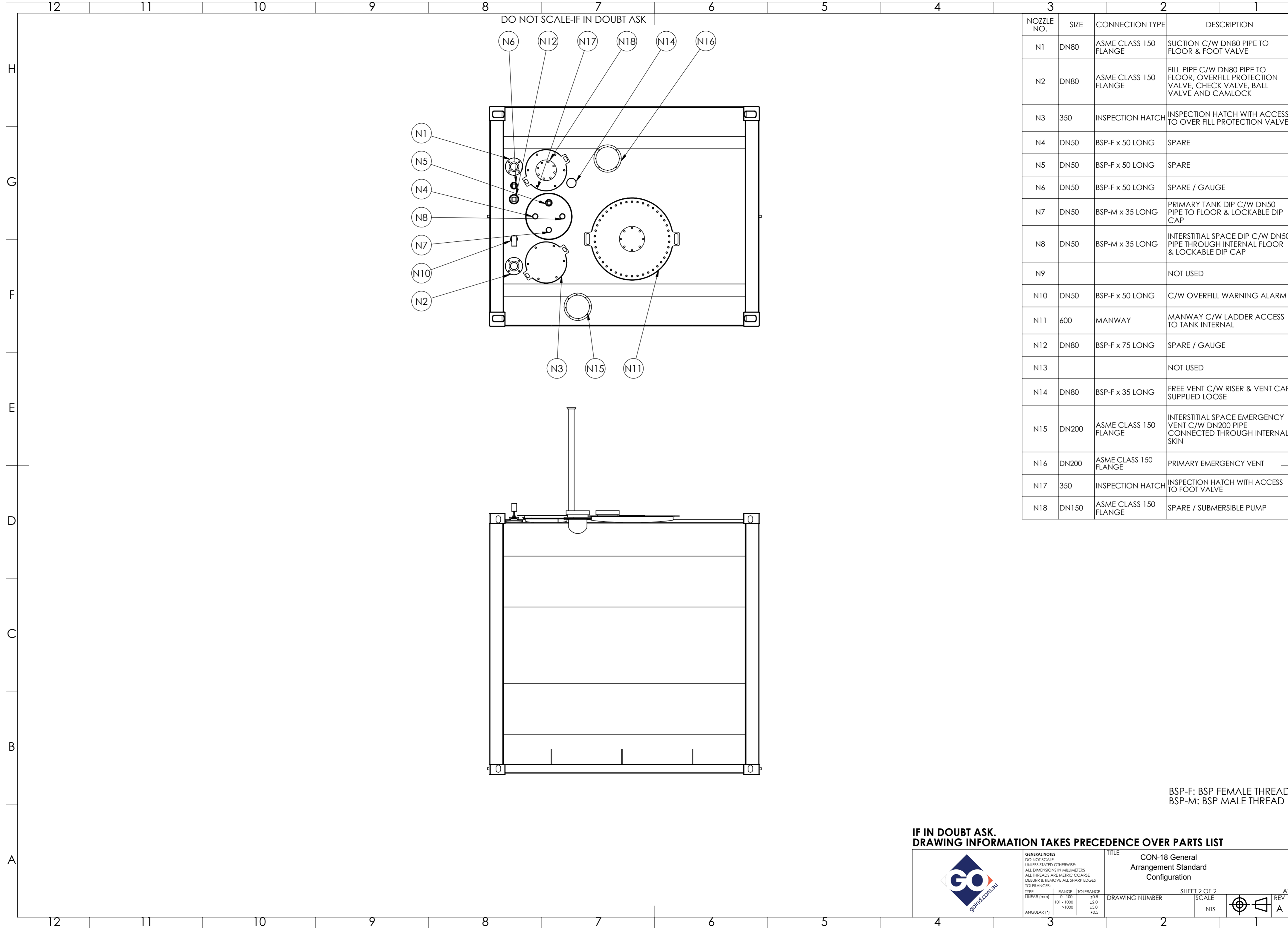

DO NOT SCALE-IF IN DOUBT ASK

NOZZLE NO.	SIZE	CONNECTION TYPE	DESCRIPTION
N1	DN80	ASME CLASS 150 FLANGE	SUCTION C/W DN80 PIPE TO FLOOR & FOOT VALVE
N2	DN80	ASME CLASS 150 FLANGE	FILL PIPE C/W DN80 PIPE TO FLOOR, OVERFILL PROTECTION VALVE, CHECK VALVE, BALL VALVE AND CAMLOCK
N3	350	INSPECTION HATCH	INSPECTION HATCH WITH ACCESS TO OVER FILL PROTECTION VALVE
N4	DN50	BSP-F x 50 LONG	SPARE
N5	DN50	BSP-F x 50 LONG	SPARE
N6	DN50	BSP-F x 50 LONG	SPARE / GAUGE
N7	DN50	BSP-M x 35 LONG	PRIMARY TANK DIP C/W DN50 PIPE TO FLOOR & LOCKABLE DIP CAP
N8	DN50	BSP-M x 35 LONG	INTERSTITIAL SPACE DIP C/W DN50 PIPE THROUGH INTERNAL FLOOR & LOCKABLE DIP CAP
N9			NOT USED
N10	DN50	BSP-F x 50 LONG	C/W OVERFILL WARNING ALARM
N11	600	MANWAY	MANWAY C/W LADDER ACCESS TO TANK INTERNAL
N12	DN80	BSP-F x 75 LONG	SPARE / GAUGE
N13			NOT USED
N14	DN80	BSP-F x 35 LONG	FREE VENT C/W RISER & VENT CAP SUPPLIED LOOSE
N15	DN200	ASME CLASS 150 FLANGE	INTERSTITIAL SPACE EMERGENCY VENT C/W DN200 PIPE CONNECTED THROUGH INTERNAL SKIN
N16	DN200	ASME CLASS 150 FLANGE	PRIMARY EMERGENCY VENT
N17	350	INSPECTION HATCH	INSPECTION HATCH WITH ACCESS TO FOOT VALVE
N18	DN150	ASME CLASS 150 FLANGE	SPARE / SUBMERSIBLE PUMP

BSP-F: BSP FEMALE THREAD
BSP-M: BSP MALE THREAD

**IF IN DOUBT ASK.
DRAWING INFORMATION TAKES PRECEDENCE OVER PARTS LIST**

	GENERAL NOTES DO NOT SCALE UNLESS STATED OTHERWISE- ALL DIMENSIONS IN MILLIMETERS ALL THREADS ARE METRIC COARSE DEBURR & REMOVE ALL SHARP EDGES TOLERANCES:		TITLE CON-18 General Arrangement Standard Configuration	
	TYPE LINEAR (mm) ANGULAR (°)	RANGE 0-100 101-1000 >1000	TOLERANCE ±0.5 ±2.0 ±5.0 ±0.5	SHEET 2 OF 2 DRAWING NUMBER NTS