

# RTX5000 & RTX5500 Texture Sprayers

3A3265C

EN

*For water-Based Materials Only.*

**Models: RTX5000PI, RTX5000PX, RTX5500PI & RTX5500PX**  
*100 psi (6.9 bar, 0.69 MPa) Maximum Working Pressure*



## Important Safety Instructions

Read all warnings and instructions in this manual and related manuals.  
Be familiar with the controls and the proper usage of the equipment.  
Save these instructions.

**Related Manuals**  
Gun – 3A3373



ti27921a

*Use only genuine Graco replacement parts.  
The use of non-Graco replacement parts may void warranty.*

## Contents

<b>Models</b> .....	<b>3</b>
<b>Warnings</b> .....	<b>4</b>
<b>Component Identification</b> .....	<b>7</b>
<b>Preparation</b> .....	<b>8</b>
Pressure Relief Procedure .....	8
Grounding .....	8
Power Switch .....	8
Extension Cords .....	8
Generator Requirements .....	8
SoftStart/Smart Start™ System .....	9
<b>Setup</b> .....	<b>10</b>
Material Hopper .....	11
Mixing Material .....	11
<b>Operation</b> .....	<b>13</b>
Wetting Hose .....	13
System Priming .....	13
Texture Spraying .....	14
Recommended Nozzle & Disc Selection Charts .....	15
Adjusting the System .....	16
<b>Shutdown and Cleanup</b> .....	<b>18</b>
Gun .....	19
Clean Material Hopper .....	19
<b>Maintenance</b> .....	<b>20</b>
Texture Hoses .....	20
Tips .....	20
<b>Troubleshooting</b> .....	<b>21</b>
<b>RTX5000, RTX5500 Sprayer Parts</b> .....	<b>24</b>
RTX5000, RTX5500 Sprayer (continued) .....	25
RTX5000, RTX5500 Sprayer (continued) .....	26
RTX5000, RTX5500 Sprayer Parts List .....	27
<b>Compressor Assembly Parts</b> .....	<b>29</b>
Compressor Parts List .....	30
<b>Wiring Diagrams</b> .....	<b>31</b>
120V .....	31
230V .....	32
<b>Technical Specifications</b> .....	<b>33</b>
<b>Graco Standard Warranty</b> .....	<b>35</b>
<b>Graco Information</b> .....	<b>36</b>

# Models

	VAC	Model	
	120 USA	RTX5000pi	17H575
		RTX5000pi Rental	17H576
		RTX5000pi Rental HD	17K302
		RTX5000px	17H579
	240 USA	RTX5500px	17H581
 Intertek 110474 Certified to CAN/CSA C22.2 No. 68 Conforms to UL 1450	120 USA	RTX5000pi	17L288
		RTX5000pi Rental	17L289
		RTX5000px	17L292
	230 Europe Multi	RTX5500pi	17H577
		RTX5500px	17H580
	230 LA Asia	RTX5500pi	17H578
		RTX5500px	17K680

## Warnings

The following warnings are for the setup, use, grounding, maintenance, and repair of this equipment. The exclamation point symbol alerts you to a general warning and the hazard symbols refer to procedure-specific risks. When these symbols appear in the body of this manual or on warning labels, refer back to these Warnings. Product-specific hazard symbols and warnings not covered in this section may appear throughout the body of this manual where applicable.

### **WARNING**



#### **GROUNDING**

This product must be grounded. In the event of an electrical short circuit, grounding reduces the risk of electric shock by providing an escape wire for the electric current. This product is equipped with a cord having a grounding wire with an appropriate grounding plug. The plug must be plugged into an outlet that is properly installed and grounded in accordance with all local codes and ordinances.

- Improper installation of the grounding plug is able to result in a risk of electric shock.
- When repair or replacement of the cord or plug is required, do not connect the grounding wire to either flat blade terminal.
- The wire with insulation having an outer surface that is green with or without yellow stripes is the grounding wire.
- Check with a qualified electrician or serviceman when the grounding instructions are not completely understood, or when in doubt as to whether the product is properly grounded.
- Do not modify the plug provided; if it does not fit the outlet, have the proper outlet installed by a qualified electrician.
- This product is for use on a nominal 120V or 230V circuit and has a grounding plug similar to the plugs illustrated below.

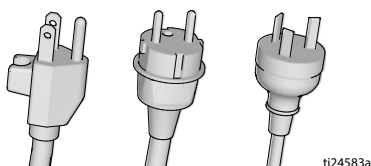









- Only connect the product to an outlet having the same configuration as the plug.
- Do not use an adapter with this product.

#### **Extension Cords:**

- Use only a 3-wire extension cord that has a grounding plug and a grounding receptacle that accepts the plug on the product.
- Make sure your extension cord is not damaged. If an extension cord is necessary use 12 AWG (2.5mm<sup>2</sup>) minimum to carry the current that the product draws.
- An undersized cord results in a drop in line voltage and loss of power and overheating.

## **WARNING**

  	<p><b>FIRE AND EXPLOSION HAZARD</b></p> <p>Flammable fumes, such as solvent and paint fumes, in work area can ignite or explode. To help prevent fire and explosion:</p> <ul style="list-style-type: none"> <li>• Do not spray or clean with flammable materials. Use water-based materials only.</li> <li>• Use equipment only in well ventilated area.</li> <li>• Sprayer generates sparks. When flammable liquids are used near the sprayer, keep sprayer at least 20 feet (6.1 meters) away from explosive vapors.</li> <li>• Keep work area free of debris, including solvent, rags and gasoline.</li> <li>• Ground all equipment in the work area. See <b>Grounding</b> instructions.</li> <li>• Keep a working fire extinguisher in the work area.</li> </ul>
 	<p><b>EQUIPMENT MISUSE HAZARD</b></p> <p>Misuse can cause death or serious injury.</p> <ul style="list-style-type: none"> <li>• Always wear appropriate gloves, eye protection, and a respirator or mask when painting.</li> <li>• Do not operate or spray near children. Keep children away from equipment at all times.</li> <li>• Do not overreach or stand on an unstable support. Keep effective footing and balance at all times.</li> <li>• Stay alert and watch what you are doing.</li> <li>• Do not operate the unit when fatigued or under the influence of drugs or alcohol.</li> <li>• Do not kink or over-bend the material or air hose.</li> <li>• Do not expose the hose to temperatures or to pressures in excess of those specified by Graco.</li> <li>• Do not use the hose as a strength member to pull or lift the equipment.</li> <li>• Do not alter or modify equipment. Alterations or modifications may void agency approvals and create safety hazards.</li> <li>• Make sure all equipment is rated and approved for the environment in which you are using it.</li> </ul>
	<p><b>BURN HAZARD</b></p> <p>Equipment surfaces and fluid that is heated can become very hot during operation. To avoid severe burns:</p> <ul style="list-style-type: none"> <li>• Do not touch hot fluid or equipment.</li> </ul>
 	<p><b>ELECTRIC SHOCK HAZARD</b></p> <p>This equipment must be grounded. Improper grounding, setup, or usage of the system can cause electric shock.</p> <ul style="list-style-type: none"> <li>• Turn off and disconnect power cord before servicing equipment.</li> <li>• Connect only to grounded electrical outlets.</li> <li>• Use only 3-wire extension cords.</li> <li>• Ensure ground prongs are intact on power and extension cords.</li> <li>• Do not expose to rain. Store indoors.</li> </ul>

# Warnings

## **WARNING**

### **PRESSURIZED EQUIPMENT HAZARD**



Fluid from the equipment, leaks, or ruptured components can splash in the eyes or on skin and cause serious injury.



- Follow the **Pressure Relief Procedure** when you stop spraying/dispensing and before cleaning, checking, or servicing equipment.
- Tighten all fluid connections before operating the equipment.
- Check hoses, tubes, and couplings daily. Replace worn or damaged parts immediately.

### **MOVING PARTS HAZARD**



Moving parts can pinch, cut, or amputate fingers and other body parts.



- Keep clear of moving parts.
- Do not operate equipment with protective guards or covers removed.
- Pressurized equipment can start without warning. Before checking, moving, or servicing equipment, follow the **Pressure Relief Procedure** and disconnect all power sources.

### **PLASTIC PARTS CLEANING SOLVENT HAZARD**



Many solvents can degrade plastic parts and cause them to fail, which could cause serious injury or property damage.



- Use only compatible water-based solvents to clean plastic structural or pressure-containing parts.
- See **Technical Data** in this and all other equipment instruction manuals. Read fluid and solvent manufacturer's Safety Data Sheet (SDS) and recommendations.

### **PERSONAL PROTECTIVE EQUIPMENT**



Wear appropriate protective equipment when in the work area to help prevent serious injury, including eye injury, hearing loss, inhalation of toxic fumes, and burns. This protective equipment includes but is not limited to:

- Protective eyewear, and hearing protection.
- Respirators, protective clothing, and gloves as recommended by the fluid and solvent manufacturer.

### **CALIFORNIA PROPOSITION 65**

This product contains a chemical known to the State of California to cause cancer, birth defects or other reproductive harm. Wash hands after handling.

## Component Identification

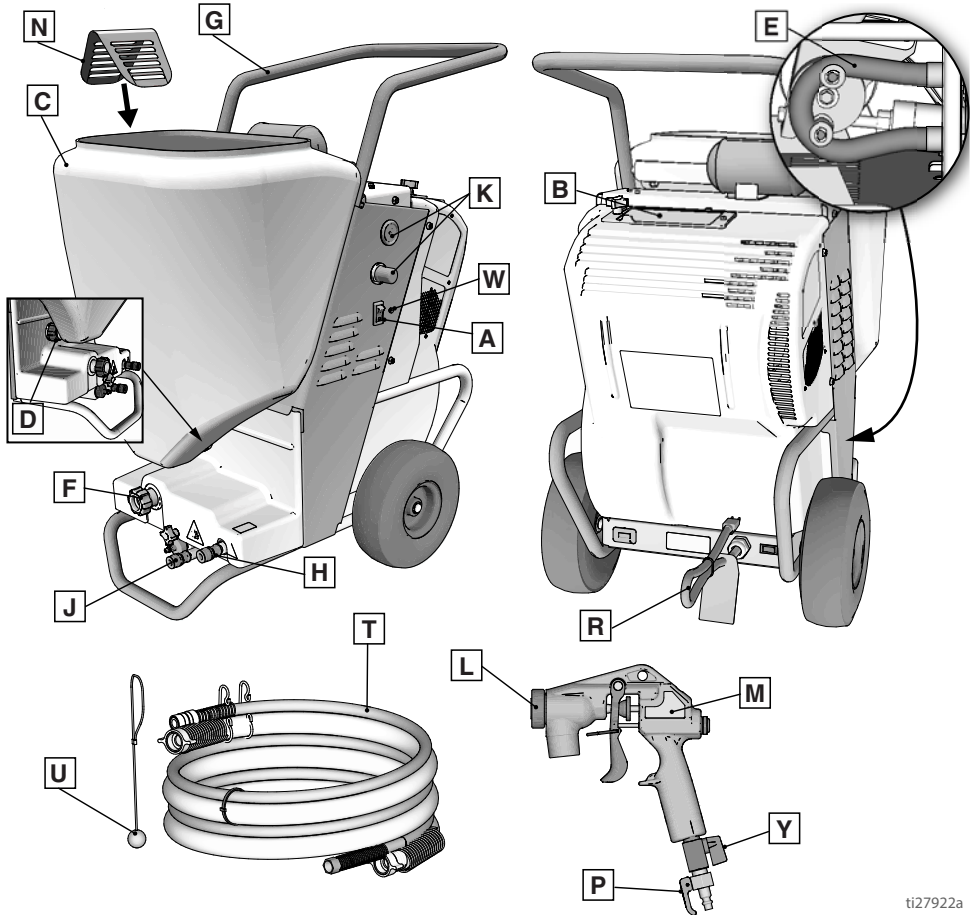

ti27922a

A	ON/OFF Switch
B	Tool Box
C	Material Hopper
D	Hopper Connect/Disconnect
E	RotoFlex™ II Pump
F	Pump Hose Outlet
G	Handle
H	Air Hose Outlet
J	Auxiliary Air Hose Inlet (px models only)
K	Fluid Flow Regulator and Pressure Gauge

L	Gun Nozzle
M	Gun
N	Burp Guard
P	Prime Valve
R	Power Cord
T	Hose - 25-ft (7.6 m)
U	Material Thickness Gauge
V	Cleaning (Sponge) Ball
W	ProGuard
Y	Air control valve
	Model/Serial Tag (Not shown, located on bottom of unit.)

## Preparation

### Pressure Relief Procedure



Follow the Pressure Relief Procedure whenever you see this symbol.



This equipment stays pressurized until pressure is manually relieved. To help prevent serious injury from pressurized fluid or splashed fluid follow the **Pressure Relief Procedure** whenever sprayer is stopped and before sprayer is cleaned or checked, and before equipment is serviced.

1. Turn ON/OFF switch to the **OFF** position. Wait 7 seconds for power to dissipate.

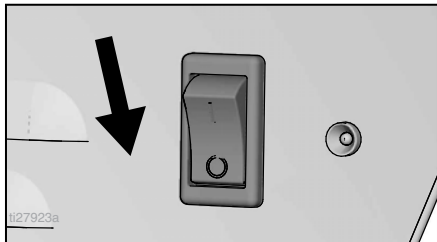

2. Unplug sprayer.
3. Turn fluid regulator all the way down.
4. Aim gun into hopper or waste bucket and trigger the gun until all air and material pressure is relieved.

## Grounding



The equipment must be grounded to reduce the risk of static sparking and electric shock. An electric or static spark can cause fumes to ignite or explode. An improper ground can cause electric shock. A good ground provides an escape wire for the electric current.

This sprayer includes a ground wire with an appropriate ground contact. The plug must be plugged into an outlet that is properly installed and grounded in accordance with all local codes and ordinances.

Do not modify the plug provided; if it does not fit the outlet, have the proper outlet installed by a qualified electrician.

## Power Switch

A selector switch on the sprayer allows you to operate the sprayer on either a 10A/240V 15A/120V or 16A/240V or 20A/120V circuit.

### 120V Sprayers

Select 15A or 20A depending on your circuit rating.

### 240V Sprayers

Select 10A or 16A depending on your circuit rating.

## Extension Cords

Use an extension cord with an undamaged ground contact. If an extension cord is necessary, use a 3-wire, 12 AWG (2.5 mm<sup>2</sup>) minimum.

**NOTE:** Lighter gauge or longer extension cords may reduce sprayer performance.

## Generator Requirements

7500 W (7.5 kW) minimum.



## Hose Size and Length

The system comes with a 25 ft (7.6m) long hose set consisting of a material hose 1 in. or 1.25 in. I.D. and a 3/8 in. I.D. air hose.

## SoftStart/Smart Start™ System

### “Soft Start” vs. “Smart Start”

- “Smart” refers to the function where the motor starts and stops when the trigger is pulled and released. This keeps the sprayer at full operating pressure and allows the sprayer to spray immediately when the gun is triggered.
- “Soft” refers to the function where the sprayer slowly starts the pump. This prevents a large “splotch” of material from being discharged from the gun when trigger is pulled after the sprayer has sat idle for a period of time.

## Soft Start

The Soft Start System is controlled by motor power and an air cylinder. When pressurized, the air cylinder pushes the rollers into the peristaltic pump pushing material through the pump. When the motor shuts off, a solenoid valve relieves the pressure in the air cylinder causing the rollers to disengage from the peristaltic pump. When the motor starts again there is a time delay while the air cylinders charge and move the rollers into the pump this is the “Soft Start”.

## Smart Start

The Smart Start System is controlled by compressed air in the tanks and lines. When gun is triggered, air flows through the lines and opens a flow switch. There is also another pressure switch that senses when the compressed air system is at operating pressure. This second pressure switch allows the sprayer to start immediately when the sprayer is turned ON charging the compressed air system to full pressure. This method keeps the compressed air system at operating pressure if there is a small air leak in the system.

## Setup



### NOTICE

- Do not store sprayer under pressure.
- Do not allow material to dry inside pump, hoses, gun or spray system. This may cause pump to fail.

When unpacking sprayer for the first time or after long term storage perform setup procedure.

1. Connect one end of air hose to sprayer air outlet quick connect and to gun air inlet quick connect.

When auxiliary air is used connect one end of air hose to lower sprayer air outlet quick connect and to gun air inlet quick connect. Connect auxiliary air source to male coupler on sprayer.

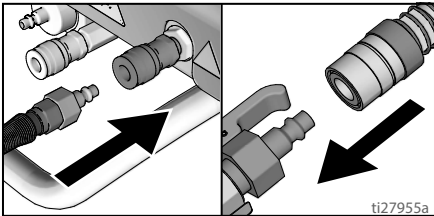

2. Connect one end of material hose to material outlet and the other end to gun material inlet. Firmly tighten connections.

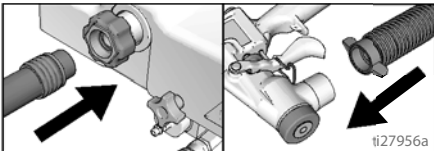

3. Install spray nozzle. See **Recommended Nozzle & Disc Selection Charts**, page 15. Pulling trigger when installing nozzle makes assembly easier.

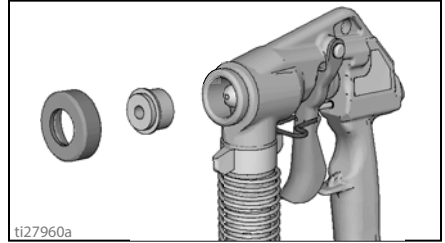

4. Plug power cord into a properly grounded outlet.
5. Make sure burp guard is installed.

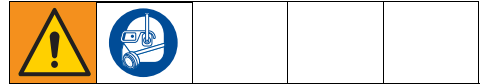

Before adding material to the hopper, install the burp guard. When only a small amount of material remains in the hopper, the burp guard prevents material from shooting out when the unit is turned off. This material could splash in the operator's eyes or on skin, or into the air.

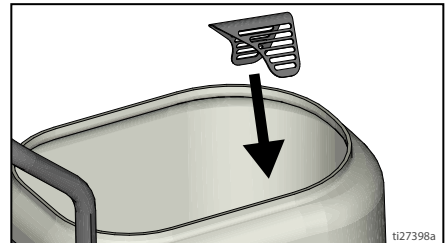

## Material Hopper

### Install Hopper

1. Position hopper outlet over fitting as far as it will go.

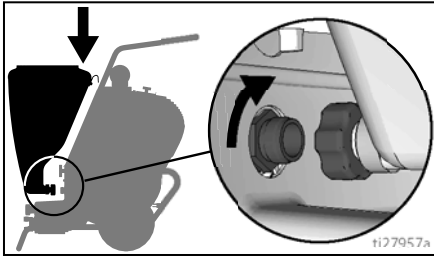

2. Hand tighten fitting.

### Remove Hopper

Material hopper can be removed for easy cleaning.

1. Loosen outlet fitting. Fittings are hand-tightened and should not require tools to loosen.

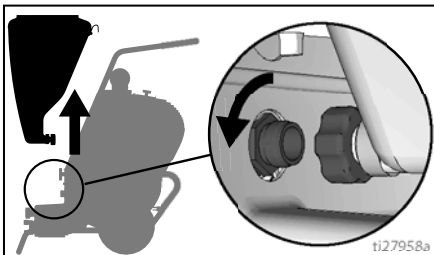

2. Lift material hopper straight up, off the unit.

## Mixing Material



**NOTE:** Correct material mixture is essential. The pump will not operate if the mixture is too thick. Use water-based materials only.

- Mix the material in a separate container before pouring it into hopper.
  - Use Material Thickness Gauge to determine if mixture is thin enough to spray.
  - The Material Thickness Gauge will only determine if the material is thin enough to pass through the pump. For some applications or for higher speed spraying, your mixture may need to be thinner.
  - If thicker materials are desired, test pumping performance first. Then spray a test pattern.
  - For best results, do not use partial bags of material.
1. Mix the material and water in a separate container.

### Dry Mix - 40 lb (18 kg) bag

Carefully mix texture material and water according to manufacturer instructions on bag.

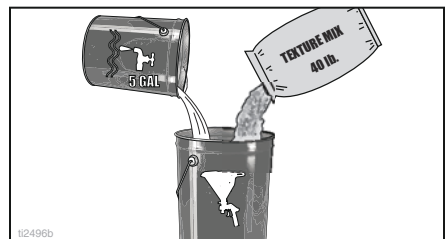

# Setup

## Premix

Slowly add approximately 2 to 4 quarts (1.9 to 3.8 liters) of water to a 5 gallon (18.9 liter) bucket of premix.

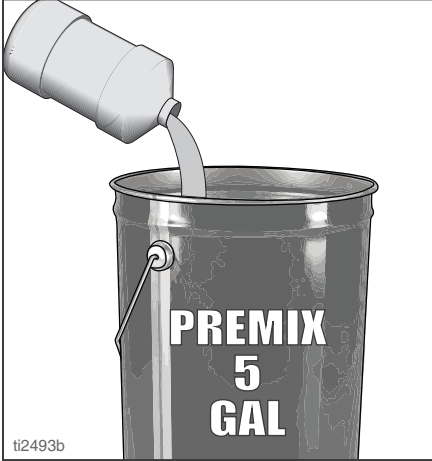

2. Agitate to mix, using a half-inch, variable speed drill with mixing paddle, to a smooth, lump-free consistency.



3. Allow ceiling texture to set for at least 15 minutes. Then remix prior to use.
4. After texture material is thoroughly mixed, gently set ball end of Material Thickness Gauge on surface of mixture.

**NOTE:** For an accurate test, be sure gauge is completely dry and clean every time it is used.

5. Observe the ball on the material. When the material is thin enough to spray the ball will sink completely into the mixture within 10 seconds.

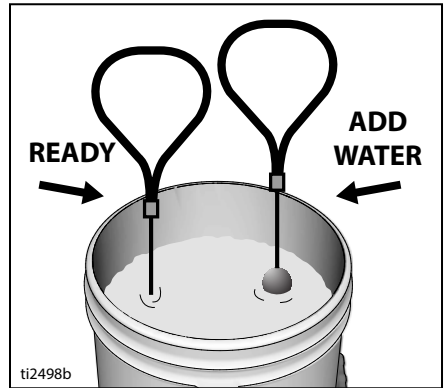

6. If the ball does not sink completely into the mixture within 10 seconds, add more water, agitate and try test again.

## Operation

For the best spraying experience always follow the Setup and Operation process. This ensures that the material and sprayer are ready to spray resulting in a successful project.



## Wetting Hose

Wet inside of hose before each use to flush out sediment and prevent texture material from packing out hose.

1. Pour one gallon (3.8 liters) of water into the material hopper.

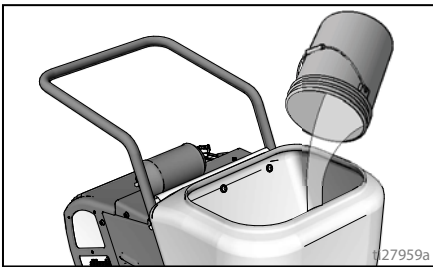

2. Open gun air control valve.
3. Turn ON/OFF switch to **ON** position. Aim gun into hopper and trigger gun to circulate water for a few minutes to wet inside of material hose.

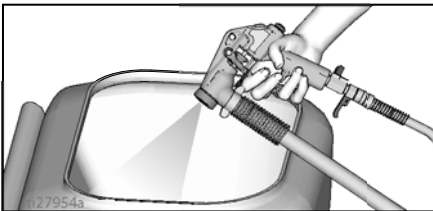

4. Trigger gun into waste pail until hopper no longer contains water and all water is removed from hose and pump system.

### NOTICE

To prevent pump damage, before adding material or starting unit in cold weather, run warm water through the pump.

## System Priming

The system recognizes air flow at the gun when detected by an air flow sensor located inside the sprayer.

### Preferred Method

1. Turn ON/OFF switch to **ON** position.
2. Open gun air control valve slightly, allowing a small amount of air to flow with material through gun. This automatically delivers material pressure and flow.

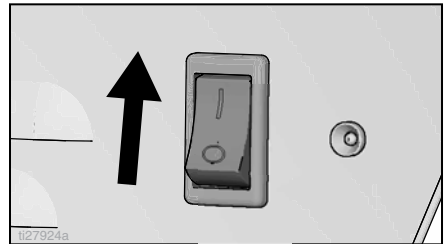

3. Aim gun into hopper and trigger the gun.

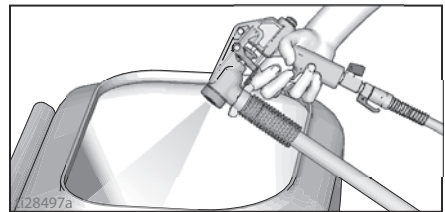

# Operation

## Alternate Method (Using Prime Valve)

Use this method when air flow with material through gun is not desired

1. Turn ON/OFF switch to **ON** position.
2. Turn fluid flow regulator up as necessary.



3. Close gun air control valve.

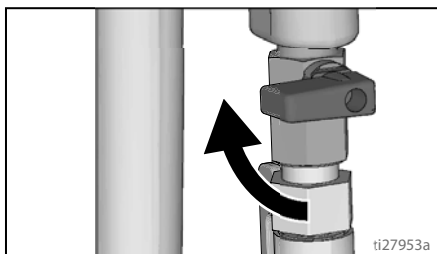

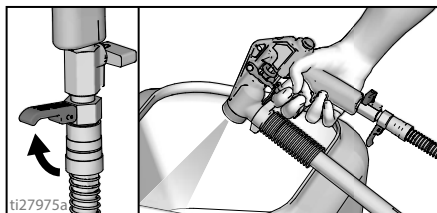

4. Open Prime Valve to start flow. Aim gun into hopper and trigger the gun.



### NOTICE

Excessive or prolonged use of Prime Valve can cause material to back up into gun air passages, causing blockage and/or gun air control valve failure.

				
Air hose fittings can get hot. Allow sprayer to cool down 15 minutes before removing air hose.				

## Texture Spraying

1. Fill hopper with prepared texture material.
2. Install nozzle or nozzle and disc. See **Recommended Nozzle & Disc Selection Charts**, page 15.

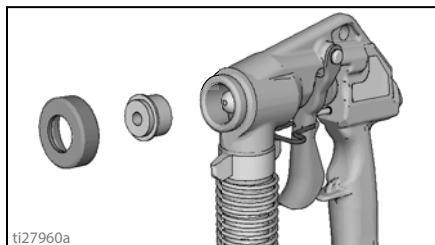

3. Open gun air control valve. Make certain prime valve is closed.

### NOTICE

To avoid material pack-out in needle, do not allow material to flow out of gun when air control valve is closed for a sustained amount of time.

If material gets in needle or gun air passages, flush with water immediately.

4. Inspect 25 ft. material hose for kinks which could restrict fluid flow.

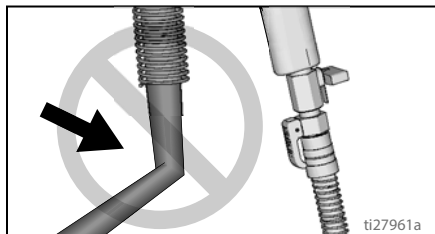

- Follow **Mixing Material**, page 11.
- Trigger gun into a pail. When texture material appears at nozzle, move gun to hopper and circulate until there is a solid stream of texture material.
- To achieve uniform spray pattern, adjust air control valve and flow adjustment nut on gun. If you do not achieve the desired pattern, change nozzles, see **Recommended Nozzle & Disc Selection Charts**, page 15.

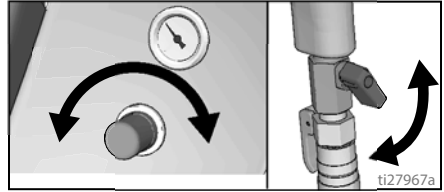
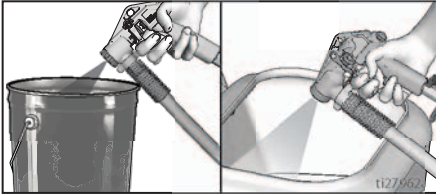

- For proper spray pattern and pump and gun adjustments, see **Adjusting the System**, page 16.

## Recommended Nozzle & Disc Selection Charts

### Nozzle

Application	Nozzle Size <sup>2</sup>	Air Volume <sup>1</sup>	Application	Nozzle Size <sup>2</sup>	Air Volume <sup>1</sup>
Fog	3 mm	high	Knockdown	6-12 mm	low
Simulated Acoustic	4 mm	medium to high	Textured Elastomerics	8-12 mm	high <sup>3</sup>
	6 mm		Plastics	8-10 mm	high <sup>3</sup>
	8-10 mm		EIFS	8-12 mm	high <sup>3</sup>
Orange peel	3-4 mm	medium to high	Stucco	10-12 mm	high <sup>3</sup>
	4-8 mm		Knockdown	6-12 mm	low
Splatter coat	6-8 mm	low to medium			
	6-10 mm				

<sup>1</sup>Control air volume with gun air control valve.

<sup>2</sup>For more material volume try a larger orifice tip.

<sup>3</sup>Some materials may require the addition of external air to improve production rate. Use External Air Hookup Kit 287328.

### WideTex™ Disc

Application	WideTex Disc		Nozzle (mm)	Air Volume
	Standard	Hardened		
Simulated Acoustic - Fine	W6	W6H	4	high
	W8	W8H	6	high
	W10	W10H	8- 10	high
Fog	W4	W4H	3	high
Orange peel	W4 or W6	W4H or W6H	3 - 8	medium to high
Splatter coat	W6 or W8	W6H or W8H	6 - 10	low to medium
Knockdown	W6 or W8	W6H or W8H	6 - 8	low

## Adjusting the System

Sufficient fluid output (volume and pressure) and good atomization is a balance of atomizing air, material thickness/material flow and nozzle selection. Achieving the correct balance for your application requires experimentation to achieve desired results. Keep in mind these important points when adjusting gun:

- To select correct nozzle for your applications, consider size of aggregate in material and coarseness of spray pattern. Remember the larger the nozzle, the larger the pattern. See **Recommended Nozzle & Disc Selection Charts**, page 15.
- Start sprayer with gun air control valve completely open. If needed, slowly close gun air control valve until you get a good spray pattern. Use minimum amount of air at spray gun to achieve proper spray pattern and to minimize bounce back.
  - + Test spray pattern on cardboard. Hold gun 18 to 30 in. (45.7 to 76.2 cm) from surface. Use this spraying distance for most applications.
  - + When spraying with a nozzle only overlap each stroke 50% in a circular motion.
  - + When spraying with a nozzle and disc overlap each stroke 50% in a linear motion.
- Material flow is controlled with the fluid flow regulator knob and displayed on the gauge. Gun air flow is regulated using air control valve located on the gun handle.
  - + Opening air control valve increases air flow through gun, which decreases texture material flow through pump.
  - + Closing air control valve decreases air flow through gun, which increases texture material flow through pump.

## For Less Material Flow

Try one or a combination of these methods:

- Open air control valve.
- Turn gun flow adjustment nut to decrease flow, counter-clockwise.
- Use smaller nozzle.

## For More Material Flow

Try any one or a combination of these methods:

- Close air control valve.
- Turn gun flow adjustment nut clockwise to increase flow.
- Use thinner material mixture.
- Use a larger nozzle.

## Preventing Material Surge at Gun Trigger

Pressure will build up in the system when you stop triggering the gun. To prevent material surge at initial gun triggering:

- Point gun away from surface you are spraying when you first pull trigger.
- When you first start to spray, hold the gun away from the surface and gradually work your way closer to it.
- Keep gun moving.
- After you begin spraying, trigger the gun as little as possible.

## For Continuous Spraying

Use trigger lock to hold trigger open and reduce fatigue.

## Check Material Consistency Periodically

Check and thin material as needed to maintain proper consistency. The material may thicken as it sits and slow down production. Agitate periodically.



## Smart Start/Soft Start Operation

### Smart Start

Sprayer will start under the following conditions:

- A new sprayer is plugged in and ON/OFF switch is turned **ON**.
- Gun is triggered and air control valve is open far enough.
- There is a small leak in the system and the pressure drops below the pressure switch setting. This may appear to be random operation.
- When a bleeder gun is used.
- When the pressure is relieved by triggering the gun while the sprayer is OFF and then turned back ON.
- Prime valve is opened.
- There is a hose failure (leak) in the twin line hose.



### Soft Start

- The easiest way to tell if the Soft Start System is functional is to spray material.
- The system is operating properly when a small amount of material initially comes out of the gun when triggered and the volume of material slowly increases to full spray.

**NOTE:** Motor runs when gun is triggered. Sprayer is designed to stop pumping when gun trigger is released.

## ProGuard

This sprayer protects itself against high and low voltage. If the sprayer is plugged into a power source that is too low or too high the sprayer will stop operating. This light has three different states of operation: ON, blink, and OFF.

Error Code	Definition
	<b>Light is ON</b> Unit is powered and operating normally.
	<b>Light is Blinking</b> Voltage supply is too low or too high for sprayer and will not run until it is plugged into a good power supply.
	<b>Light is OFF</b> No power to sprayer, or there is another error other than the voltage supply.

### NOTICE

The sprayer handle is for pushing or pulling the sprayer only. Do not use sprayer handle for lifting the unit, sprayer damage may occur.

# Shutdown and Cleanup

## Shutdown and Cleanup



**NOTE:** Keep pump and hose clean when switching between materials. A dirty pump can release particles of texture into the finish.

- To increase pump life, life turn ON/OFF switch OFF when not spraying.
- Before removing material hose, perform **Pressure Relief Procedure**, page 8. Make certain there is no material in the hose.
- To keep sprayer in good operating condition, always clean it thoroughly and prepare it properly for storage.

When you have finished spraying:

1. Drain remaining material into bucket until most of texture material is out of the hopper.
2. Fill material hopper with clean water.
3. Remove nozzle from gun. Trigger gun into bucket until most of texture mix is pumped out. Allow water to flow through gun until gun is clean.

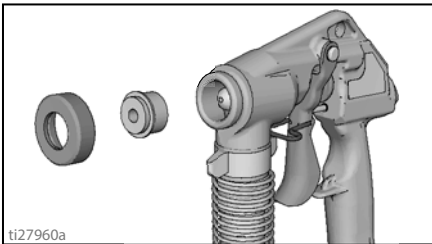

4. Open gun air control valve, forcing air through nozzle to clear out any remaining material.
5. Disconnect air line and material hose from gun.

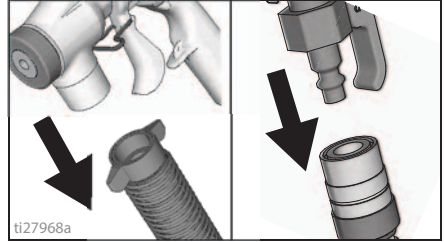

6. Disconnect material hose from sprayer.

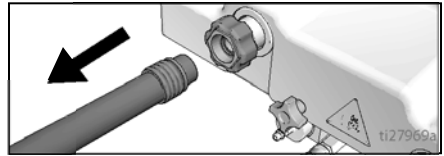

7. Insert sponge ball in material hose.

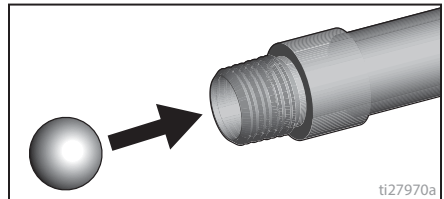

8. Connect material hose to sprayer.
9. Pour a couple of gallons (8 liters) of clean water in the hopper.
10. Place the end of the material hose in a waste bucket.
11. Turn ON/OFF switch to **ON** position. Wait for sprayer to power up.
12. Circulate water through sprayer until sponge ball comes out of the hose.
13. Retrieve sponge ball and clean with clear water.
14. Spray water into a waste bucket to empty material hopper.
15. Turn ON/OFF switch to **OFF** position.

# Shutdown and Cleanup

16. Open gun air control valve. Perform **Pressure Relief Procedure**, page 8.
17. Finish cleaning all components. Be sure to keep air passages in needle clean and free of material. Clean inside of gun.

**NOTE:** A soft brush can be used to loosen dried on material.

## Gun

To ensure proper gun function for future use, remove and clean needle components and apply a few drops of light oil to:

- Air hose quick connect
- Material hose connections
- Air shutoff needle material needle See *Gun Manual for Needle removal/repair.*

## Clean Material Hopper

Material hopper can be removed for easy cleaning.

1. Loosen bottom fitting

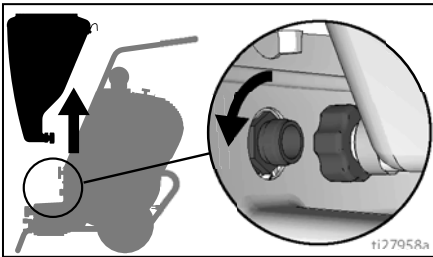

2. Lift material hopper straight up, off the unit.
3. Plug opening on bottom of material hopper with your hand.

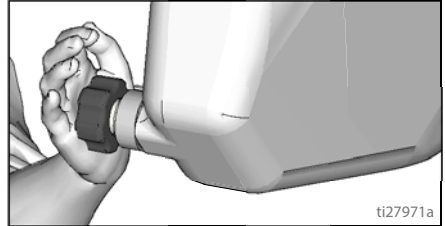

4. Take hopper to cleaning area for cleaning.
5. After cleaning material hopper, position it on sprayer aligning fitting to sprayer.
6. Hand tighten fitting.

### NOTICE

Water or material remaining in unit when temperatures are below freezing can damage motor and/or delay pump startup. Do not allow unit to freeze.

To ensure water and material are completely drained out of unit:

1. Remove material hose from sprayer.
2. Remove pump hose from sprayer. Empty hose and reinstall.
3. Remove hopper and drain.

## Maintenance

Routine maintenance is important to ensure proper operation of your sprayer. Maintenance includes performing routine actions which keep your sprayer in operation and prevent trouble in the future.



Component	Task	Interval
Sprayer	Inspect motor shield vents for blockage.	Daily or each time you spray
Hoses	Check for wear and/or damage.	Daily
	Drain system of all water.	After each use
Air and material hose connections	Add a few drops of light oil.	Daily
RotoFlex HD pump	Flush	Daily
	Check thread connections for wear.	Replace pump hose upon failure
Gun	Clean	After each use
	Add a few drops of light oil to needle under trigger.	After each use

**Protect the internal drive parts of this sprayer from water.** Openings in shields allow cooling of mechanical parts and electronics inside. If water gets into these openings, the sprayer could malfunction or be permanently damaged.

## Texture Hoses

Check hose for damage every time you spray. Do not attempt to repair hose if hose jacket or fittings are damaged. Do not use hoses shorter than 25 ft (7.6 m).

## Tips

- Always clean tips with a soft brush after spraying.
- Tips may require replacement depending on abrasiveness of texture.

## Troubleshooting

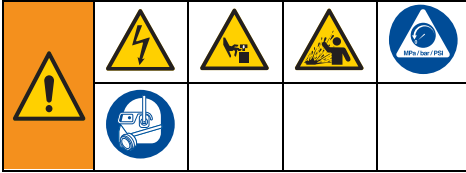

1. Follow **Pressure Relief Procedure**, page 8, before checking or repairing.
2. Check all possible problems and causes before disassembling the unit.

Problem	Cause	Solution
Sprayer won't run	Power switch not on	Turn switch on.
	No power at wall outlet	Check outlet by plugging in another appliance. If appliance does not work, try another outlet.
	Wrong size generator	Use a 7500 watt or larger generator. Refer to Generator Requirements, page 8.
	Circuit breaker tripped	Reset breaker.
Pump won't pump material	Air lock	Open air control valve on gun.
	Mix too thick	Add water to thin material. Use Material Thickness Gauge.
	Loose fittings	Check and retighten all fittings.
	Plugged gun	Perform <b>Pressure Relief Procedure</b> , page 8. Remove gun from hose. Clean gun.
	Pump hose worn out	Replace hose. Recommended hose replacement - once every year.
	Pump cold	Move pump to warm room and allow it to warm up or run hot water through sprayer.
Material runs out of bottom of sprayer	Pump hose worn out	Replace hose.
	Loose fittings	Check and retighten all fittings.
No air from compressor	Gun air control valve closed	Open gun air control valve.
	Low voltage	Check extension cord length and gauge. Replace if different than recommended. Refer to Grounding and Electrical Requirements, page 8.
	Gun needle plugged	Clean needle and retry.
	Worn compressor	Replace compressor. Contact a qualified Graco Service Center.
	Loose belt	Tighten belt by adjusting compressor
	Broken belt	Replace belt
	Lines not connected	Check all quick disconnect connections to gun and hoses.
	Damaged hose.	Replace hose.



# Troubleshooting

Problem	Cause	Solution
Speed of application slow or slower	Material too thick	Thin material.
	Nozzle too small	Change nozzles to a larger size. See Recommended Nozzle Selection Chart, page 15.
	Too much air being used.	Partially close gun air control valve to reduce air flow.
	Pump hose worn	Replace hose.
	Plugged or dirty gun	Perform <b>Pressure Relief Procedure</b> , page 8. Clean gun.
	Kinked hose	Unkink hose.
	Gun adjustment set too low	Increase flow adjustment with flow adjustment nut.
	Too many items on same circuit	Unplug other items from circuit.
Intermittent flow/sputtering	Extension cord too long or wrong gauge	Use a different extension cord. Refer to Grounding and Electric Requirements, page 8.
	Hopper connection not tight	Check gasket. Tighten connection.
Quick disconnect does not stay connected.	Debris in system	Clean system.
	Dirty or corroded fitting	Clean thoroughly. Soak in oil. Apply a few drops of light oil.
Gun will not shut off	Worn nozzle or needle	Perform <b>Pressure Relief Procedure</b> , page 8. Replace worn parts.
	Debris in needle passage	Perform <b>Pressure Relief Procedure</b> , page 8. Clean.
Fluid leaking at Flow Adjustment Nut	Damaged seal	Perform <b>Pressure Relief Procedure</b> , page 8. Replace seal.
Needle adjustment won't adjust	Dirty threads	Clean threads.
	Nozzle not on gun	Put nozzle on gun.
Power switch is on and sprayer is plugged in, but motor does not run, and pump does not cycle.	Air control valve on gun is closed or not open enough	Open air control valve.
	Motor or control is damaged	Take sprayer to Graco authorized service center.
	Electric outlet is not providing power.	Try a different outlet or plug in something that you know is working to test outlet.  Reset building circuit breaker or replace fuse.
	Extension cord is damaged.	Replace extension cord. See <b>Grounding</b> , page 8.
	Sprayer electric cord is damaged.	Check for broken insulation or wires. Replace electric cord if damaged.

<b>Problem</b>	<b>Cause</b>	<b>Solution</b>
Power switch is on and sprayer is plugged in, but motor does not run, and pump does not cycle. (cont'd)	Material and/or water is frozen or hardened in pump.	Unplug sprayer from outlet. If frozen do NOT try to start sprayer until it is completely thawed or you may damage the motor, control board and/or drivetrain.  Make sure power switch is OFF. Place sprayer in a warm area for several hours. Then plug in powercord and turn sprayer ON. Slowly increase pressure setting to see if motor will start.  If material is hardened in sprayer, pump or pressure switch may need to be replaced. Take sprayer to Graco authorized service center.
	Prime valve is plugged	Remove and clean prime valve.
	Gun is plugged.	Disassemble and clean gun.
Sprayer continues to run when gun trigger is released.	Pressure switch is damaged.	Replace pressure switch.
	Compressed air system leak.	Locate leak; check gun, twin line hose, or internal system. Reseal leaky fitting or replace hose.
	Flow switch is stuck.	Replace flow switch.
Sprayer does not start when gun is triggered.	Flow switch is stuck.	Replace flow switch.
Sprayer cycles ON and OFF when trigger is released.  or Sprayer cycles ON and OFF when gun is triggered.	Pressure switch is damaged.	Replace pressure switch.
	Compressed air system leak.	Locate leak; check gun, twin line hose, or internal system. Reseal leaky fitting or replace hose.
	Flow switch is stuck.	Replace flow switch.
	Check valve is damaged.	Replace check valve.

# RTX5000, RTX5500 Sprayer Parts

## RTX5000, RTX5500 Sprayer Parts

Ref.	Torque
	Hand tighten
	50-70 in-lb (5.7 - 7.9 N•m)

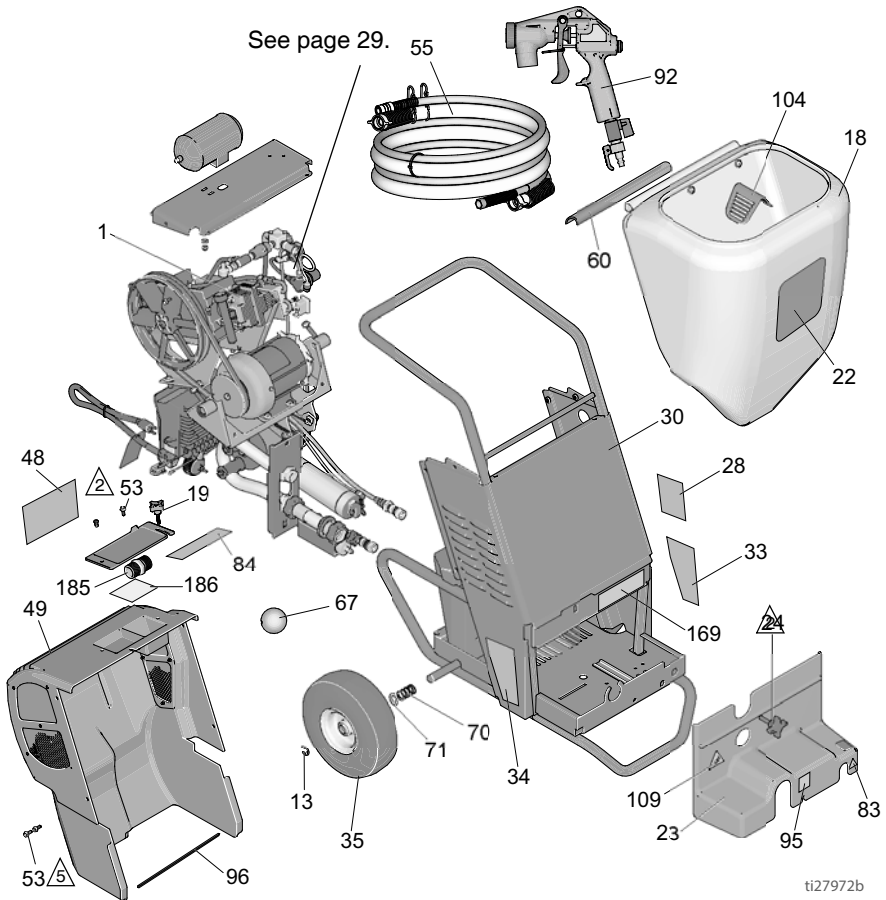



# RTX5000, RTX5500 Sprayer Parts

## RTX5000, RTX5500 Sprayer (continued)



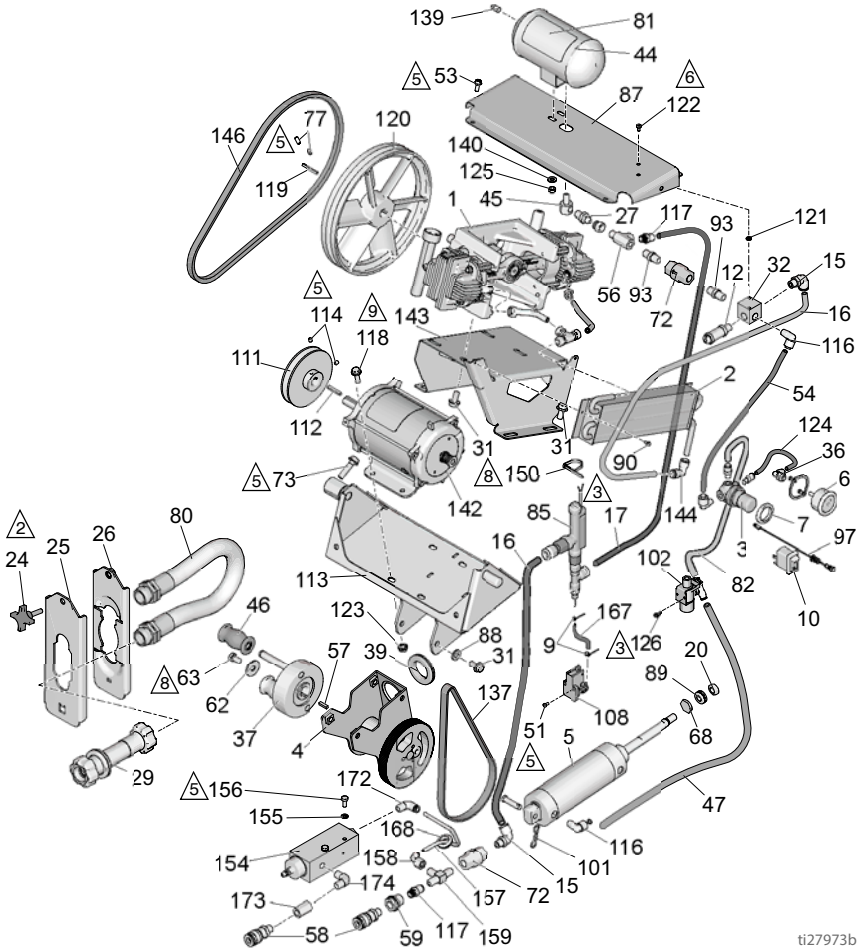



Ref.	Torque	Ref.	Torque	Ref.	Torque
⚠	9-11 in-lb (1 - 1.2 N•m)	⚠	50-70 in-lb (5.7 - 7.9 N•m)	⚠	10-14.5 ft-lb (13.5 - 19.7 N•m)
⚠	Hand tighten	⚠	40-45 in-lb (4.5 - 5.1 N•m)		
⚠	27-32 in-lb (3.1 - 3.6 N•m)	⚠	37.5-42.5 ft-lb (51 - 58N•m)		



ti27973b

# RTX500, RTX550 Sprayer Parts

## RTX500, RTX550 Sprayer (continued)

Ref.	Torque	Ref.	Torque	Ref.	Torque
	37.5-42.5 ft-lb (51 - 57.6 N•m)		200-230 in-lb (22.6 - 26 N•m)		40-45 in-lb (4.5 - 5.1 N•m)
	15-20 in-lb (1.1 - 2.3 N•m)		9-11 in-lb (1.0 - 1.2 N•m)		27-32 in-lb (3.1 - 3.6 N•m)

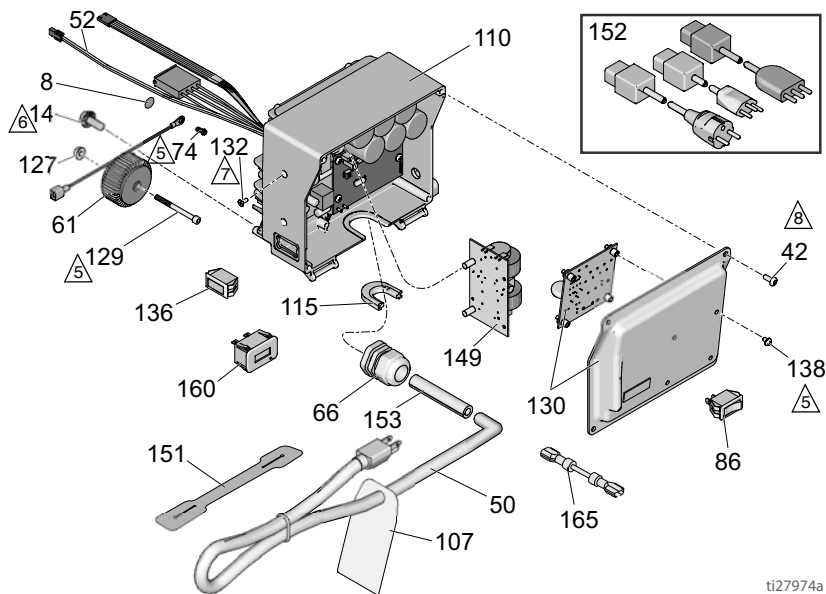

ti27974a

# RTX5000, RTX5500 Sprayer Parts

## RTX5000, RTX5500 Sprayer Parts List





Ref.	Part	Description	Qty.	Ref.	Part	Description	Qty.
1	24S149	KIT, repair, compressor <i>includes 31, 77, 119, 120, 146</i>	1	39	127282	GROMMET, rubber	1
2	24S154	KIT, repair, cooler <i>includes 90, 144, 166, 167, also includes 15, 19, 20, 21 found on page 29</i>	1	42	16V095	SCREW, machine, self-tapping	4
3	118844	RÉGULATOR, air	1	44	24S148	KIT, repair, accumulator <i>includes 27, 45, 125, 139, 140</i>	1
4	17L033	KIT, repair, pump housing	1	45	158962	FITTING, elbow	1
5	287323	CYLINDER, air <i>includes 20, 68, 89</i>	1	46	287321	KIT, repair, roller	2
6	117720	GAUGE, pressure <i>includes 36</i>	1	47	★	TUBE, air, 1/4	1
7	115244	NUT, regulator	1	48▲	15H841	LABEL, warning	1
8	186620	LABEL, symbol, ground	1	49	17S091	ASSEMBLY, shield, rear	1
9	103473	STRAP, tie, wire	2	50		CORD, power	1
10	120660	SWITCH, rocker	1		15R876	17H581, 17K680	1
12	120617	VALVE, pressure relief	1		17A242	17H578	1
13	120211	RING, retaining	2		16M836	17H577, 17H578, 17H580	1
14	117791	SCREW, cap	2		17H708	17H575, 17H576, 17H579	1
15	121141	FITTING, elbow, swivel	1	15G958		CORD SET, adapter, 17H578	1
16	★	TUBE, air, 3/8	1	253103		KIT, accessory, cordset, global, 17H577, 17H580	1
17	★	TUBE, air, 3/8	1		17L032	17L288, 17L292, 17L289, 20 amp	1
18	17P495	HOPPER, 15 gallon <i>includes 60</i>	1	51	117317	SCREW, pan head	2
19	15D862	NUT, hand	1	52	17H700	CONNECTOR, electrical	1
20	118871	NUT, lock, 1/2-20	1	53	117633	SCREW, slot, HWH	9
22		LABEL, hopper	1	54	★	TUBE, air, 1/4	1
	17J510	RTX5000px	1	55		HOSE, texture, 2line	1
	17K874	RTX5000pi	1		17L005	17H579, 17H580, 17H581, 17K680	1
	17J511	RTX5000pi Rental	1		17J420	All other models	1
	17K313	RTX5500pi	1	56	116504	FITTING, tee	1
	17K314	RTX5500px	1	57	183401	KEY, parallel	1
23	287348	SHIELD, front	1	58	116720	COUPLER, quick disconnect	2
24	108471	KNOB	1	59	104641	FITTING, bulkhead	1
25	17J295	BRACKET, hose, outer	1	60	15D366	PAD, isolator	1
26	17J296	BRACKET, hose, inner	1	61	24S152	KIT, repair, choke <i>includes 74, 127, 129</i>	1
27	156823	FITTING, union, swivel	1	62	108851	WASHER, plain	1
28▲	17K674	LABEL, warning	1	63	106276	SCREW, cap, hex head	1
29	118885	HOSE, coupled	1	66	116171	BUSHING, strain relief	1
30	17J684	FRAME, RTX, painted	1	67	113397	BALL, sponge, 30mm	2
31	112395	SCREW, cap, flange head	12	68	15D576	SPACER, crowned	1
32	17J681	MANIFOLD, pneumatic	1	70	116411	SPRING, compression	2
33		LABEL, right	1	71	116477	WASHER, flat, nylon	2
	17K315	RTX5000pi	1	72	24S146	KIT, repair, check valve	1
	17K321	RTX5000pi Rental	1	73	112785	SCREW, hex head	2
	17K316	RTX5000px	1	74	115498	SCREW, slot, HWH	1
	17K322	RTX5500pi	1	77	120087	SCREW, set, 1/4x1/2	2
	17K323	RTX5500px	1	80	287314	HOSE, coupled, pump	1
34	17K324	LABEL, left	1	81	17J933	LABEL, smart start	1
35	17K405	WHEEL, pneumatic	2	82	★	TUBE, air, 1/4	1
36	120653	FITTING, push to connect	1	83▲	15K616	LABEL, caution	1
37	287255	KIT, repair, roller	1	85	24S145	KIT, repair, flow switch <i>includes 9, 150, 167, 171</i>	1

# RTX500, RTX550 Sprayer Parts

Ref.	Part	Description	Qty.	Ref.	Part	Description	Qty.
86		SWITCH, rocker		119228		SCREW, mach, flat-head, all other models	2
	120059	120V	1				
	126029	230V	1	136	16T483	PLUG, hole, switch	1
87	17J682	COVER, top, painted	1	137	17J675	BELT, synchronous	1
88	118866	WASHER, flat, thick	5	138	108860	SCREW, mach, pan head	4
89	801012	GROMMET	1	139	100403	PLUG, pipe	1
90	103785	RIVET	2	140	110755	WASHER, plain	2
92		GUN, spray, texture		142	24S147	KIT, repair, motor	1
	24S134	INTERIOR, pi models	1			<i>includes 111, 112, 114, 118, 123, 137, 146</i>	
	24S135	EXTERIOR, px models	1				
93	156971	FITTING, nipple, short	2	143	17J676	BRACKET, compressor	1
96	17K478	GROMMET, edge	1	144	17J677	FITTING, tube, 90° elbow	1
95		LABEL		146	17J678	BELT, VEE	1
	17L028	INTERIOR, pi models	1	149	24Z000	BOARD, filter, 17H577, 17H578, 17H580, 17K680	1
	17L029	EXTERIOR, px models	1				
97	17H703	HARNES, wiring, with light	1	150	17L903	CLAMP, spring, tube	1
101	117668	PIN, cotter	1	151	121249	LOCK, cord, 17H577, 17H578, 17H580	1
102		KIT, repair, solenoid					
		<i>includes 126</i>		153	15F480	HOSE, strain relief, 17H577, 17H578, 17H580	1
	17K597	120V	1				
	24S144	230V	1				
104	17H705	BAFFLE, hopper	1	154	17M550	VALVE, remote air, <i>includes 15, 72, 155, 156, 158, 159, 172, 173, 174 px models</i>	1
108	17K596	KIT, repair, pressure	1				
109▲	16C394	LABEL, warning	2	155	100016	WASHER, lock, px models	2
110		KIT, repair, control board		156	100270	SCREW, cap, hex head, px models	2
		<i>includes 14, 115, 132, 136</i>		157	★	TUBE, air, 1/4, px models	1
	24S126	120V	1				
	24S127	230V	1	158	C20350	FITTING, elbow, 90°, px models	1
111	15E588	PULLEY	1	159	113548	FITTING, tee, px models	1
112	117632	KEY, square, 3/16	1	160	246013	KIT, meter, hour, 17H576	1
113	17L031	FRAME, motor	1	165	17H648	WIRE, jumper, 17H581	1
114	100002	SCREW, set	2	167	★	TUBE, air, 0.365	2
115	16T547	ADAPTER, cord	1	169	17L084	LABEL, instructions, pump, install	1
116	17L559	FITTING, tube, 90° elbow	2	170	★	TUBE, air, 3/8	1
117	17J393	FITTING, tube, straight	1	171		FITTING	1
118	112586	SCREW, cap, hex head	4	172	113321	FITTING, elbow, tube	1
119	17H649	KEY, square, 5/32	1	173	100175	COUPLING, pipe	1
120	15E410	PULLEY, fan	1	174	110249	ADAPTER, male elbow 90°	1
121	100020	WASHER, lock	2	185	15E359	FITTING, nipple	1
122	110637	SCREW, machine, pan head	2	186	17X931	LABEL, info	1
123	110996	NUT, hex, flange head	4	★	17L026	KIT, tube, air <i>includes 16, 17, 47, 54, 82, 124, 157, 167, 170</i>	1
124	★	TUBE, air, 1/4	1				
125	102040	NUT, lock, hex	2				
126	17J525	SCREW, slot, HWH	2				
127	127908	NUT, flange, 120V only	1				
129	107404	SCREW, cap, 120V only	1				
130	24S153	KIT, repair, interface	1				
		<i>includes 11, 42, 138</i>					
132		FASTENER					
	16T482	RIVOT, snap, 17H575, 17H576, 17H579, 17K581	2				

▲Replacement Danger and Warning labels, tags, and cards are available at no cost.

## Compressor Assembly Parts

Ref.	Torque	Ref.	Torque
	Piston retaining bolt and crankshaft bolts must be torqued before head bolts (14) are torqued.		165-185 ft-lb (18.6 - 20.9 N•m)
	50-65 in-lb (5.7 - 7.3 N•m)		Hand tighten then one additional full turn.
	120-140 in-lb (13.6 - 15.8 N•m) Finger tighten cap screw in position 4 first then torque cap screws in the sequence illustrated.		

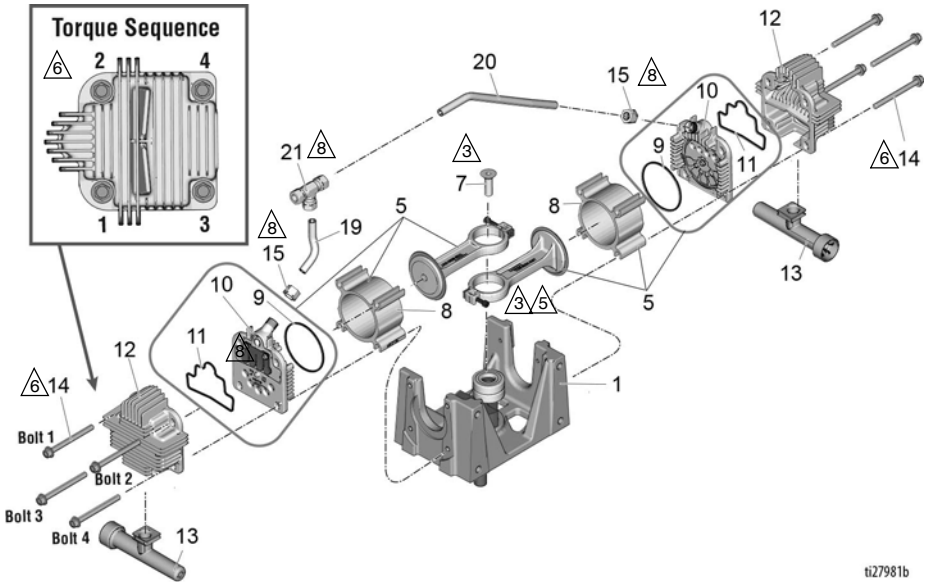

ti27981b

# Compressor Assembly Parts

## Compressor Parts List

Ref.	Part	Description	Qty.	Ref.	Part	Description	Qty.
1	17S362	COMPRESSOR, pump, assembly	1	14*	17H560	SCREW, cap serrated flange head	8
5*	24S150	KIT, repair, piston and cylinder <i>includes 8, 9, 10, 11</i>	2	15*	17H561	NUT, compression with sleeve	2
7	120204	SCREW, mach, hex	1	19	17H635	TUBE, heat exchanger, left	1
8*	17H553	CYLINDER, compressor	2	20	17H636	TUBE, heat exchanger, right	1
9*	17H554	O-RING, square	2	21	17H659	FITTING, compression, tee, 3/8	1
10*	24S131	KIT, repair plate valve <i>Includes 9, 11</i>	2				
11*	17H555	O-RING, head, formed square	2		24S151	KIT, repair, compressor rebuild, also <i>includes 146 found in RTX5000, RTX5500 Sprayer Parts List</i>	1
12*	24S130	KIT, repair, compressor head <i>includes 9, 10, 11</i>	2				
13*	17H657	FILTER, intake muffler tube	2				

# Wiring Diagrams

120V

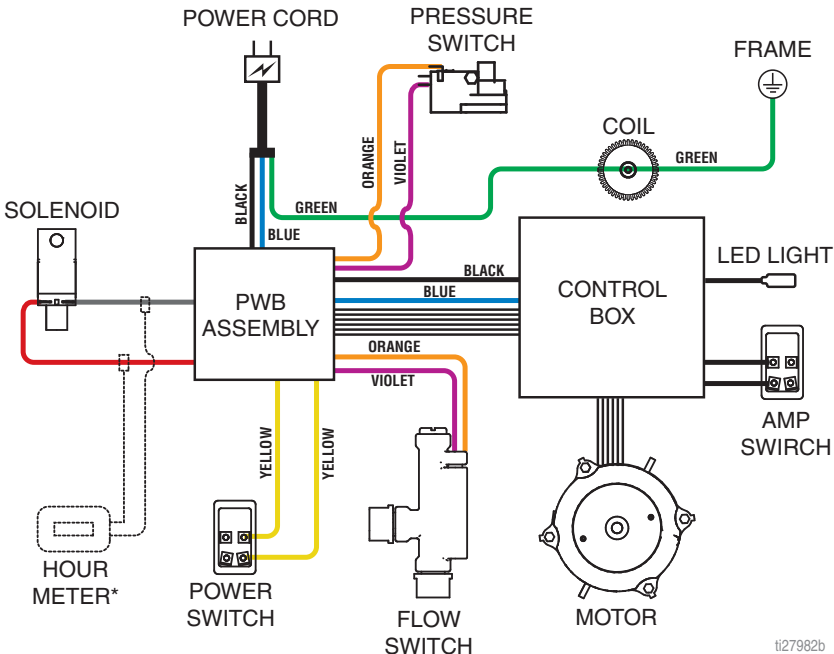

1127982b

# Wiring Diagrams

230V

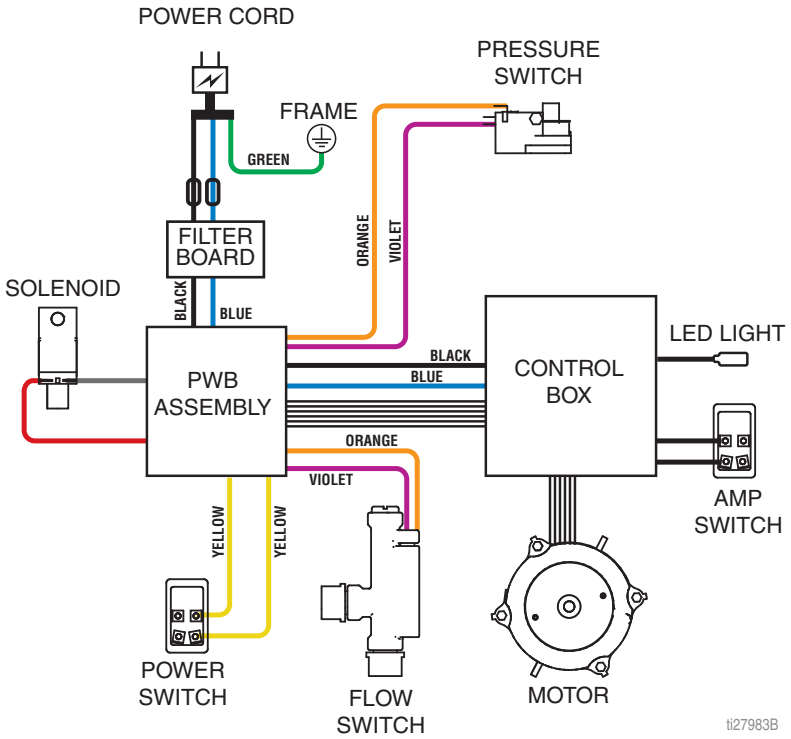



## Technical Specifications

	US	Metric
<b>Sprayer</b>		
Material Hopper Capacity	15 gal	57 l
Maximum Delivery with Texture		
RTX5000	5.0 gpm	18.9 lpm
RTX5500	5.5 gpm	20.8 lpm
Maximum Fluid Working Pressure	100 psi	6.9 bar, 0.7 MPa
Maximum Air Working Pressure	50 psi	3.5 bar, 0.35 MPa
Compressor Air Displacement		
RTX5000PI		
15A @ 110–120V or	6.6 cfm @ 20 psi	187 l/m @ 1.3 bar, 0.13 MPa
20A @ 110–120V	8.6 cfm @ 20 psi	244 l/m @ 1.7 bar, 0.17 MPa
RTX5500PI		
10A @ 220–230V or	7.7 cfm @ 20 psi	218 l/m @ 1.5 bar, 0.15 MPa
16A @ 220–230V	9.1 cfm @ 20 psi	258 l/m @ 1.8 bar, 0.18 MPa
Compressor Specifications	Belt drive oil-less	
Electric Motor DC brush less		
RTX5000PI	15A @ 110–120V or 20A @ 110–120V	
RTX5500PI	10A @ 220–230V or 16A @ 220–230V	
Power Cord		
RTX5000	12 AWG, 3-wire, 25 ft	
RTX5500	14 AWG, 3-wire, 25 ft	
Generator Minimum	7500 W	
Power Requirements	110–120V, 15/20 A, 1Ø 220–230V, 10/16 A, 1Ø	
<b>Dimensions</b>		
Height	39.5 in.	100 cm
Length	33.75 in.	86 cm
Width	22.75 in.	58 cm
Weight (includes hose and gun)		
RTX5000PI/RTX5500PI	164 lb.	74.4 kg
RTX5000PX/RTX5500PX	174 lb.	78.9 kg
Weight (gun)	2.3 lb.	1.0 kg
Storage temperature range ♦♦	–35° to 160°F	–1.6° to 71°C
Operating temperature range ✓	40° to 115°F	4° to 46°C

# Technical Specifications

	US	Metric
<b>Noise** (dBa) @ max air pressure)</b>		
Sound pressure	81.8 dBa*	
Sound power	90.9 dBa*	
<b>Materials of Construction</b>		
Wetted materials on all models	brass, aluminum, plastic, stainless steel, plated carbon steel, elastomer	
<b>Notes</b>		
<p>* <i>Startup pressures and displacement per cycle may vary based on suction condition, discharge head, air pressure, and fluid type.</i></p> <p>** <i>Sound pressure measured 3 feet (1 meter) from equipment while spraying.</i></p> <p><i>Sound power measured per ISO-9614.</i></p>		

- ◆ **Pump damage will occur if water-based fluid freezes in pump.**
- ❖ Damage to plastic parts may result if impact occurs in low temperature conditions.
- ✓ Temperature affects material viscosity, which can affect sprayer performance.

## Graco Standard Warranty

Graco warrants all equipment referenced in this document which is manufactured by Graco and bearing its name to be free from defects in material and workmanship on the date of sale to the original purchaser for use. With the exception of any special, extended, or limited warranty published by Graco, Graco will, for a period of twelve months from the date of sale, repair or replace any part of the equipment determined by Graco to be defective. This warranty applies only when the equipment is installed, operated and maintained in accordance with Graco's written recommendations.

This warranty does not cover, and Graco shall not be liable for general wear and tear, or any malfunction, damage or wear caused by faulty installation, misapplication, abrasion, corrosion, inadequate or improper maintenance, negligence, accident, tampering, or substitution of non-Graco component parts. Nor shall Graco be liable for malfunction, damage or wear caused by the incompatibility of Graco equipment with structures, accessories, equipment or materials not supplied by Graco, or the improper design, manufacture, installation, operation or maintenance of structures, accessories, equipment or materials not supplied by Graco.

This warranty is conditioned upon the prepaid return of the equipment claimed to be defective to an authorized Graco distributor for verification of the claimed defect. If the claimed defect is verified, Graco will repair or replace free of charge any defective parts. The equipment will be returned to the original purchaser transportation prepaid. If inspection of the equipment does not disclose any defect in material or workmanship, repairs will be made at a reasonable charge, which charges may include the costs of parts, labor, and transportation.

**THIS WARRANTY IS EXCLUSIVE, AND IS IN LIEU OF ANY OTHER WARRANTIES, EXPRESS OR IMPLIED, INCLUDING BUT NOT LIMITED TO WARRANTY OF MERCHANTABILITY OR WARRANTY OF FITNESS FOR A PARTICULAR PURPOSE.**

Graco's sole obligation and buyer's sole remedy for any breach of warranty shall be as set forth above. The buyer agrees that no other remedy (including, but not limited to, incidental or consequential damages for lost profits, lost sales, injury to person or property, or any other incidental or consequential loss) shall be available. Any action for breach of warranty must be brought within two (2) years of the date of sale.

**GRACO MAKES NO WARRANTY, AND DISCLAIMS ALL IMPLIED WARRANTIES OF MERCHANTABILITY AND FITNESS FOR A PARTICULAR PURPOSE, IN CONNECTION WITH ACCESSORIES, EQUIPMENT, MATERIALS OR COMPONENTS SOLD BUT NOT MANUFACTURED BY GRACO.** These items sold, but not manufactured by Graco (such as electric motors, switches, hose, etc.), are subject to the warranty, if any, of their manufacturer. Graco will provide purchaser with reasonable assistance in making any claim for breach of these warranties.

In no event will Graco be liable for indirect, incidental, special or consequential damages resulting from Graco supplying equipment hereunder, or the furnishing, performance, or use of any products or other goods sold hereto, whether due to a breach of contract, breach of warranty, the negligence of Graco, or otherwise.

### **FOR GRACO CANADA CUSTOMERS**

The Parties acknowledge that they have required that the present document, as well as all documents, notices and legal proceedings entered into, given or instituted pursuant hereto or relating directly or indirectly hereto, be drawn up in English. Les parties reconnaissent avoir convenu que la rédaction du présente document sera en Anglais, ainsi que tous documents, avis et procédures judiciaires exécutés, donnés ou intentés, à la suite de ou en rapport, directement ou indirectement, avec les procédures concernées.

# Graco Information

For the latest information about Graco products, visit [www.graco.com](http://www.graco.com).

For patent information, see [www.graco.com/patents](http://www.graco.com/patents).

**TO PLACE AN ORDER**, contact your Graco distributor or call 1-800-690-2894 to identify the nearest distributor.



*All written and visual data contained in this document reflects the latest product information available at the time of publication.*

*Graco reserves the right to make changes at any time without notice.*

Original instructions. This manual contains English. MM 3A3265

**Graco Headquarters:** Minneapolis

**International Offices:** Belgium, China, Japan, Korea

**GRACO INC. AND SUBSIDIARIES • P.O. BOX 1441 • MINNEAPOLIS MN 55440-1441 • USA**

**Copyright 2016, Graco Inc. All Graco manufacturing locations are registered to ISO 9001.**

[www.graco.com](http://www.graco.com)

Revision C, July 2018