

# Texture Spray Gun

**For water-Based Materials Only.**

**Model: 24S134, 24S135, 24S155** non-bleeder, use with RTX Texture Sprayers  
125 psi (8.6 bar, 0.86 MPa) Maximum Air/Fluid Working Pressure

**Model: 248093** bleeder, use with GTX Texture Sprayers  
125 psi (8.6 bar, 0.86 MPa) Maximum Air/Fluid Working Pressure



## Important Safety Instructions

Read all warnings and instructions in this manual and related manuals.  
Be familiar with the controls and the proper usage of the equipment.  
Save these instructions.

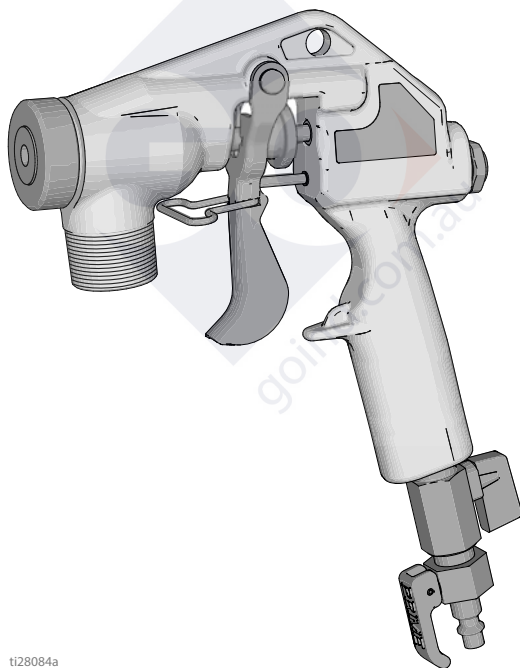

t128084a



*Use only genuine Graco replacement parts.  
The use of non-Graco replacement parts may void warranty.*

**PROVEN QUALITY. LEADING TECHNOLOGY.**

## Contents

<b>Warnings</b> .....	<b>3</b>
<b>Component Identification</b> .....	<b>5</b>
24S134, 24S135, 24S155, 248093 .....	5
<b>Setup</b> .....	<b>6</b>
Pressure Relief Procedure .....	6
Spray Disc and Nozzle Selection .....	7
<b>Gun Adjustments</b> .....	<b>8</b>
<b>Shutdown and Cleanup</b> .....	<b>9</b>
<b>Repair</b> .....	<b>10</b>
Fluid Seal Replacement .....	10
Air Seal Replacement .....	11
<b>Troubleshooting</b> .....	<b>12</b>
<b>24S134, 24S135, 24S155, 248093 Gun Parts</b> .....	<b>14</b>
Replacement WideTex Discs .....	14
24S134, 24S135, 24S155, 248093 Gun Parts List .....	15
<b>Technical Specifications</b> .....	<b>16</b>
<b>Graco Standard Warranty</b> .....	<b>17</b>
<b>Graco Information</b> .....	<b>18</b>

# Warnings

The following warnings are for the setup, use, grounding, maintenance, and repair of this equipment. The exclamation point symbol alerts you to a general warning and the hazard symbols refer to procedure-specific risks. When these symbols appear in the body of this manual or on warning labels, refer back to these Warnings. Product-specific hazard symbols and warnings not covered in this section may appear throughout the body of this manual where applicable.

## **WARNING**



### **EQUIPMENT MISUSE HAZARD**









Misuse can cause death or serious injury.

- Always wear appropriate gloves, eye protection, and a respirator or mask when painting.
- Do not operate or spray near children. Keep children away from equipment at all times.
- Do not overreach or stand on an unstable support. Keep effective footing and balance at all times.
- Stay alert and watch what you are doing.
- Do not operate the unit when fatigued or under the influence of drugs or alcohol.
- Do not kink or over-bend the hose.
- Do not expose the hose to temperatures or to pressures in excess of those specified by Graco.
- Do not use the hose as a strength member to pull or lift the equipment.
- Do not alter or modify equipment. Alterations or modifications may void agency approvals and create safety hazards.
- Make sure all equipment is rated and approved for the environment in which you are using it.



# Warnings

## **WARNING**

### **SKIN INJECTION HAZARD**

-  High-pressure fluid from dispensing device, hose leaks, or ruptured components will pierce skin. This may look like just a cut, but it is a serious injury that can result in amputation. **Get immediate surgical treatment.**
-  • Engage trigger lock when not dispensing.
-  • Do not point dispensing device at anyone or at any part of the body.
-  • Do not put your hand over the fluid outlet.
-  • Do not stop or deflect leaks with your hand, body, glove, or rag.
-  • Follow the **Pressure Relief Procedure** when you stop dispensing and before cleaning, checking, or servicing equipment.
-  • Tighten all fluid connections before operating the equipment.
-  • Check hoses and couplings daily. Replace worn or damaged parts immediately.

### **PLASTIC PARTS CLEANING SOLVENT HAZARD**

-  Many solvents can degrade plastic parts and cause them to fail, which could cause serious injury or property damage.
-  • Use only compatible water-based solvents to clean plastic structural or pressure-containing parts.
-  • See **Technical Data** in this and all other equipment instruction manuals. Read fluid and solvent manufacturer's Safety Data Sheet (SDS) and recommendations.

### **PERSONAL PROTECTIVE EQUIPMENT**

-  Wear appropriate protective equipment when in the work area to help prevent serious injury, including eye injury, hearing loss, inhalation of toxic fumes, and burns. This protective equipment includes but is not limited to:
  - Protective eyewear, and hearing protection.
  - Respirators, protective clothing, and gloves as recommended by the fluid and solvent manufacturer.

### **CALIFORNIA PROPOSITION 65**

This product contains a chemical known to the State of California to cause cancer, birth defects or other reproductive harm. Wash hands after handling.

## Component Identification

24S134, 24S135, 24S155, 248093

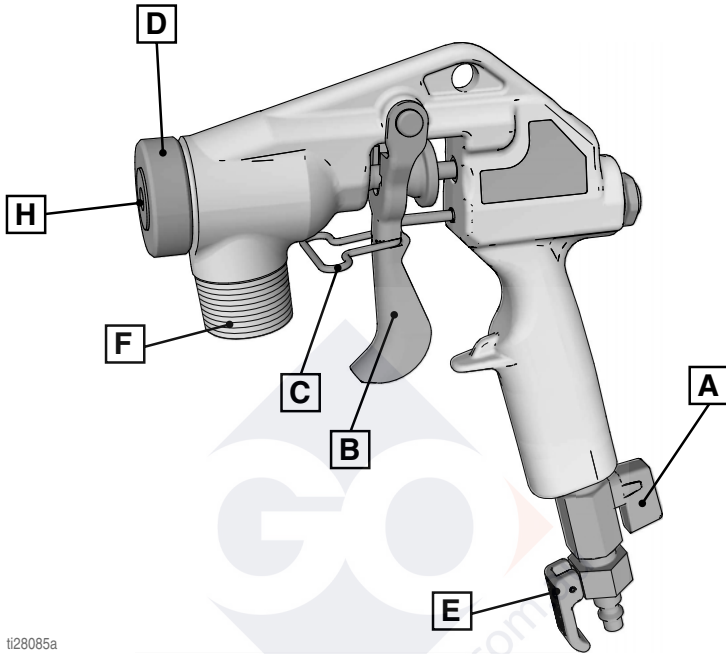

ti28085a



A	Air Control Valve
B	Trigger
C	Trigger Lock
D	Retaining ring

E	Prime Valve
F	Material Inlet
H	Nozzle

24S134, interior gun kit includes WideTex™ discs  
24S135, exterior gun kit includes hardened WideTex discs  
24S155, gun only without WideTex discs  
248093, bleeder gun

# Setup

## Setup

				
Air hose fittings can get hot! Allow sprayer to cool down 15 minutes before removing air hose.				

1. Connect air and material hoses to gun. Firmly tighten connections.

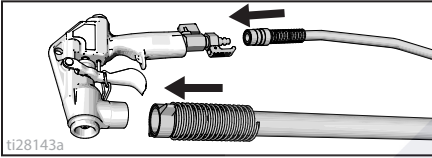

2. If using **WideTex adapter**, install disc (2) on front of adapter (3) with retaining ring (1). Install a standard nozzle (4) on front of gun with the assembly. Pulling trigger when installing nozzle makes assembly easier. If desired finish is not achieved, try a different size standard nozzle. See **Recommended Nozzle & Disc Selection Charts**, page 7.

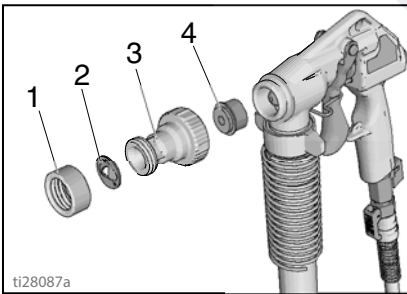

3. For **Standard operation**: install nozzle (4) on front of gun and secure using retaining ring (5). See **Recommended Nozzle & Disc Selection Charts**, page 7. Pulling trigger when installing nozzle makes assembly easier.

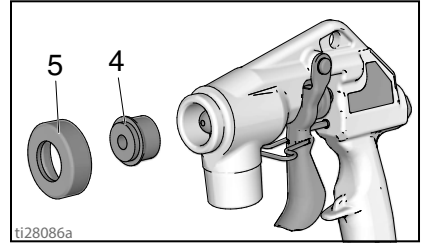

4. Refer to sprayer operation manual to start and prime the sprayer.

## Pressure Relief Procedure



Follow the Pressure Relief Procedure whenever you see this symbol.



This equipment stays pressurized until pressure is manually relieved. To help prevent serious injury from pressurized fluid and splashed fluid follow the **Pressure Relief Procedure** whenever sprayer is stopped and before sprayer is cleaned or checked, and before equipment is serviced.

1. Turn ON/OFF switch to the **OFF** position. Wait 7 seconds for power to dissipate.
2. Unplug sprayer.
3. Turn fluid regulator all the way down.
4. Shut OFF air source.
5. Aim gun into hopper or waste bucket and trigger the gun until all air and material pressure is relieved. or open Prime Valve.

## Spray Disc and Nozzle Selection

- Standard nozzles (4) are numbered 3, 4, 6, 8, 10 and 12, designating orifice size in millimeters. These parts can be interchanged to produce a pattern suitable for each job.
- For smaller droplet sizes, reduce nozzle (4) and/or disc (2) size and increase gun atomizing air by opening air valve (A) (counter-clockwise).
- For larger droplets, increase nozzle (4) and/or disc size (2) and reduce gun atomizing air by closing air control valve (A) (clockwise).

## Recommended Nozzle & Disc Selection Charts

### Nozzle

Application	Nozzle Size <sup>2</sup>	Air Volume <sup>1</sup>	Application	Nozzle Size <sup>2</sup>	Air Volume <sup>1</sup>
Fog	3 mm	high	Knockdown	6-12 mm	low
Simulated Acoustic	4 mm	medium to high	Textured Elastomerics	8-12 mm	high <sup>3</sup>
	6 mm		Plastics	8-10 mm	high <sup>3</sup>
	8-10 mm		EIFS	8-12 mm	high <sup>3</sup>
Orange peel	3-4 mm	medium to high	Stucco	10-12 mm	high <sup>3</sup>
	4-8 mm		Knockdown	6-12 mm	low
Splatter coat	6-8 mm	low to medium			
	6-10 mm				

<sup>1</sup>Control air volume with gun air control valve.

<sup>2</sup>For more material volume try a larger orifice tip.

<sup>3</sup>Some materials may require the addition of external air to improve production rate. Use External Air Hookup Kit 287328.

### WideTex™ Disc

Application	WideTex Disc		Nozzle (mm)	Air Volume
	Standard	Hardened		
<b>Simulated Acoustic</b> - Fine	W6	W6H	4	high
- Medium	W8	W8H	6	high
- Coarse	W10	W10H	8- 10	high
<b>Fog</b>	W4	W4H	3	high
<b>Orange peel</b>	W4 or W6	W4H or W6H	3 - 8	medium to high
<b>Splatter coat</b>	W6 or W8	W6H or W8H	6 - 10	low to medium
<b>Knockdown</b>	W6 or W8	W6H or W8H	6 - 8	low

## Gun Adjustments

Sufficient fluid output (volume and pressure) and good atomization is a balance of atomizing air, material thickness/material flow and nozzle selection. Achieving the correct balance for your application requires experimentation to achieve desired results. Keep in mind these important points when adjusting gun:

- To select correct nozzle for your applications, consider size of aggregate in material and coarseness of spray pattern. Remember the larger the nozzle, the larger the pattern. See **Recommended Nozzle & Disc Selection Charts**, page 7.
- Start sprayer with gun air control valve completely open. If needed, slowly close gun air control valve until you get a good spray pattern. Use minimum amount of air at spray gun to achieve proper spray pattern and to minimize bounce back.
  - + Test spray pattern on cardboard. Hold gun 18 to 30 in. (45.7 to 76.2 cm) from surface. Use this spraying distance for most applications.
  - + When spraying with a nozzle only overlap each stroke 50% in a circular motion.
  - + When spraying with a nozzle and disc overlap each stroke 50% in a linear motion.
- Material flow is controlled with the fluid flow regulator knob and displayed on the gauge. Gun air flow is regulated using air control valve located on the gun handle.
  - + Opening air control valve increases air flow through gun, which decreases texture material flow through pump.
  - + Closing air control valve decreases air flow through gun, which increases texture material flow through pump.

### For Less Material Flow

Try one or a combination of these methods:

- Open air control valve.
- Turn material flow control on sprayer to decrease flow, counter-clockwise.
- Use smaller nozzle.

### For More Material Flow

Try any one or a combination of these methods:

- Close air control valve.
- Turn material flow control on sprayer to increase flow.
- Use thinner material mixture.
- Use a larger nozzle.

### Preventing Material Surge at Gun Trigger

Pressure will build up in the system when you stop triggering the gun. To prevent material surge at initial gun triggering:

- Point gun away from surface you are spraying when you first pull trigger.
- When you first start to spray, hold the gun away from the surface and gradually work your way closer to it.
- Keep gun moving.
- After you begin spraying, trigger the gun as little as possible.

### For Continuous Spraying

Use trigger lock to hold trigger open and reduce fatigue.

### Check Material Consistency Periodically

Check and thin material as needed to maintain proper consistency. The material may thicken as it sits and slow down production. Agitate periodically.



## Shutdown and Cleanup



**NOTE:** Keep pump and hose clean when switching between materials. A dirty pump can release particles of texture into the finish.

### NOTICE

Before removing material hose be sure pressure is relieved and material is not in the hose.

To keep sprayer in good operating condition, always clean it thoroughly and prepare it properly for storage.

When you have finished spraying:

1. Drain remaining material into bucket until most of texture material is out of the hopper.
2. Fill material hopper with clean water.

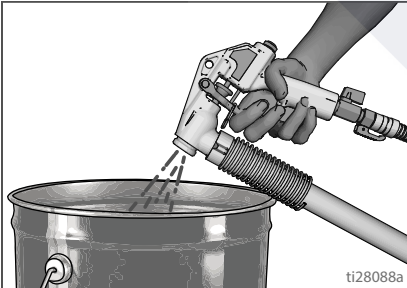

3. Remove nozzle from gun. Trigger gun into bucket until most of texture mix is pumped out. Allow water to flow through gun until gun is clean.

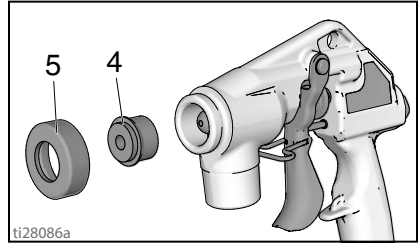

4. Finish cleaning all components. A soft brush may be used to help loosen any dried on material from surface.

**NOTE:** Cleaning out all air passages and components will improve gun performance and life.

5. Connect air line to gun. Open gun air control valve, forcing air through nozzle to clear out any remaining material.
6. Disconnect air line and material hose from gun.

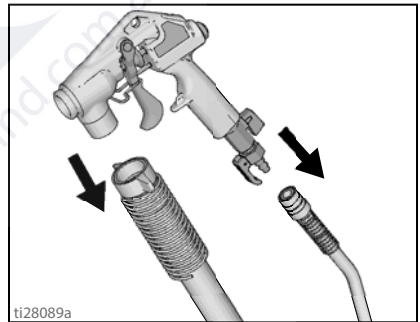

To ensure proper gun function for future use, remove and clean needle components and apply a few drops of light oil to:

- air hose quick connect
- material hose connections
- air shutoff needle material needle

## Repair

Repair involves the removal and replacement of worn or damaged parts.



### NOTICE

U-cup seals are very fragile. Never pound on seal when during assembly.

## Fluid Seal Replacement

For Non-bleeder guns use Seal Replacement Kit, 287228. For bleeder guns use Seal Replacement Kit, 287338.

1. Remove retaining ring (11), nozzle (28), and needle assembly (9) through front of gun.

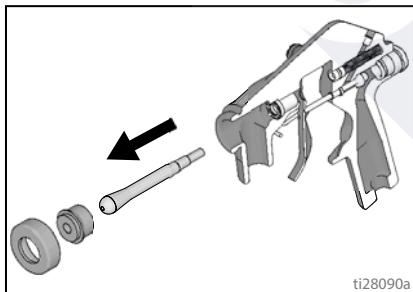

2. Use a hook-shaped object to carefully pull up-cup retainer and u-cup out of gun.

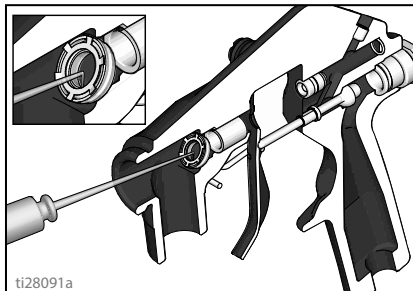

3. Using your finger or a 1/2-in. diameter rod, push new seal (3) in place. Make sure seal is seated against sleeve bearing (35).
4. Insert u-cup retaining ring (41). Make sure retaining ring is seated against u-cup (3).

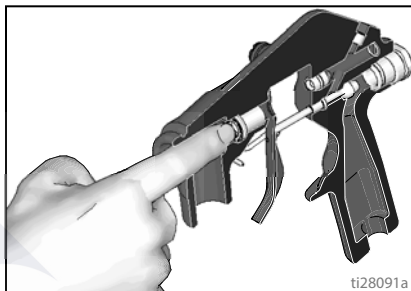

5. Graco recommends you replace the entire fluid needle assembly at this time, including the needle (9) spring (5), packing o-ring (6) and guide (7).
6. Trigger gun a few times to make sure u-cup and retainer are securely in place.

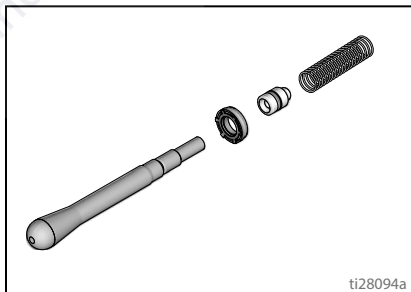

## Air Seal Replacement

(Use Seal Replacement Kit, 287229.)

1. Remove air valve retainer (21), compression spring (19), air valve seal (18) and needle (17) through back of gun.

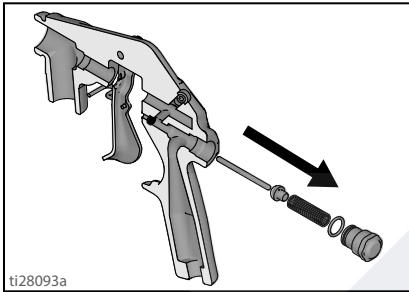

2. Use a hook-shaped object to carefully pull u-cup seal (4) out of gun.

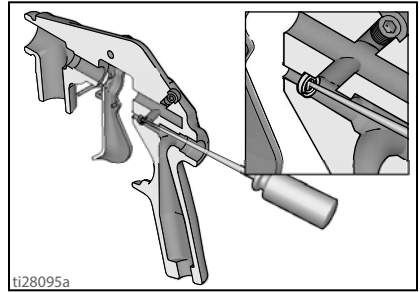

3. Push new seal (4) in place using a small diameter (1/4 in. or smaller) object. Make sure seal is seated against sleeve bearing (36).

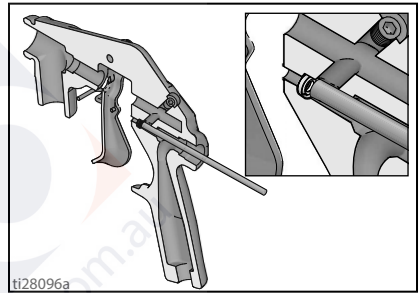

4. Replace air valve needle (17) seal (18), spring (19) and O-ring (20) if necessary.

## Troubleshooting



1. Follow , page 6, before checking or repairing.
2. Check all possible problems and causes before disassembling the unit.



Problem	What to Check If check is OK, go to next check	What to Do When check is not OK, refer to this column
Material will not flow out of gun	Material too thick	Thin material. Increase pressure at pump.
	Not enough air	Open gun air control valve (A) more (counter-clockwise)
	Trigger adjustment set too low	Rotate trigger nut clockwise to increase (adjust) trigger travel
	Nozzle too small	Increase nozzle size
	Gun is plugged	Clean gun
Pattern too fine	Material too thin	Add more dry material to mix to thicken
	Air pressure too high	Close gun air control valve (A) partially (clockwise)
	Gun needle travel too low	Rotate trigger nut clockwise to increase (adjust) trigger travel
	Nozzle too small	Replace nozzle with larger size
Pattern too coarse	Material too thick	Add water to mix to thin material
	Air pressure too low	Open gun air control valve (A) more (counter-clockwise)
	Nozzle too large	Replace nozzle with smaller size
Gun will not shut off	Worn nozzle and/or needle	Replace worn parts
	Nozzle retaining ring not on all the way	Tighten completely.
	Debris in gun passages	Clean gun.
Fluid leaking at flow needle nut (8)	Damaged seal	Replace seal (3).

<b>Problem</b>	<b>What to Check If check is OK, go to next check</b>	<b>What to Do When check is not OK, refer to this column</b>
Needle nut won't adjust	Dirty threads	Clean threads.
	Nozzle not on gun	Put nozzle on gun.
	Needle triggered	Adjust when trigger is not pulled.
Air won't shut off when gun trigger is released	Debris in gun air passages	Clean gun.
	Loose air fittings	Tighten air fittings on gun
	Worn air seals	Replace air shutoff needle u-cup (4) and/or air valve seal (18)
	Prime valve is leaking.	Remove and clean prime valve.
	Prime valve is plugged.	Remove and clean prime valve.



# 24S134, 24S135, 24S155, 248093 Gun Parts

## 24S134, 24S135, 24S155, 248093 Gun Parts

Ref.	
	90-110 in-lb (10 - 12 N•m)
	Install bearings with chamfer on outside edge first.

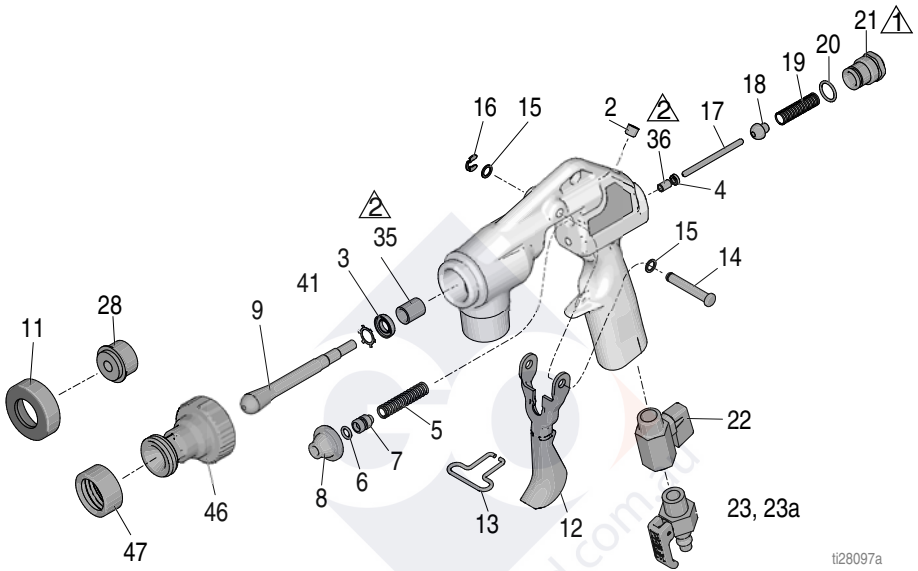

t28097a

### Replacement WideTex Discs

Part	Description	Part	Description
24S099	W4 (standard)	24S117	W10H (hardened)
24S100	W6 (standard)	24S118	W12H (hardened)
24S101	W8 (standard)	24S119	WXLH (hardened)
24S102	W10 (standard)	24S136	W4H, package of 6 (hardened)
24S103	W12 (standard)	24S137	W6H, package of 6 (hardened)
24S104	WXL (standard)	24S138	W8H, package of 6 (hardened)
24S114	W4H (hardened)	24S139	W10H, package of 6 (hardened)
24S115	W6H (hardened)	24S140	W12H, package of 6 (hardened)
24S116	W8H (hardened)	24S141	WXLH, package of 6 (hardened)

# 24S134, 24S135, 24S155, 248093 Gun Parts

## 24S134, 24S135, 24S155, 248093 Gun Parts List

Ref. Part	Description	Qty.	Ref. Part	Description	Qty.
2	103147 PLUG, pipe, Guns 24S134, 24S135, 24S155	1	28	NOZZLE	
3	15D125 SEAL, u-cup,.375 dia. shaft	1	28a	15C883 NOZZLE, texture 3mm	1
4	15D126 SEAL, u-cup, 156 dia. shaft, Guns 24S134, 24S135, 24S155	1	28b	15C884 NOZZLE, texture 4 mm	1
5	118592 SPRING, compression	1	28c	15C885 NOZZLE, texture 6 mm	1
6	156454 PACKING, o-ring	1	28d	15C886 NOZZLE, texture 8 mm	1
7	15C894 GUIDE, needle, fluid	1	28e	15C887 NOZZLE, texture 10 mm	1
8	15B163 NUT, needle	1	28f	15C888 NOZZLE, texture 12 mm	1
9	NEEDLE, fluid, assbly		35	119183 BEARING, sleeve, 0.375 1 dia. shaft	
	246972 Guns 24S134, 24S135, 24S155	1	36	119184 BEARING, sleeve, 4 mm 1 dia. shaft, 156 dia. shaft, Guns 24S134, 24S135, 24S155	
	246971 Gun 248093	1	37	KIT, repair, fluid needle, <i>includes 3, 5, 6, 7, 8, 9, 10, 16, 35</i>	
11	15B042 RING, retaining, nozzle	1	287228	Guns 24S134, 24S135, 1 24S155	
12	15C882 TRIGGER, gun	1	287338	Gun 248093	1
13	15D120 LOCK, trigger	1	38	287229 KIT, repair, air needle 1 <i>includes 4, 17, 18, 19, 20, 36</i>	
14	118717 PIN, clevis w groove	1	39	LABEL, right	
15	107243 WASHER	2	17H679	Guns 24S134, 24S135, 1 24S155	
16	115999 RING, retaining	1	15D932	Gun 248093	1
17	15C895 NEEDLE, air valve, 156 1 dia. shaft, Guns 24S134, 24S135, 24S155		40	LABEL, left	
18	15D104 SEAL, air valve, 156 dia. 1 shaft, Guns 24S134, 24S135, 24S155		17H680	Guns 24S134, 24S135, 1 24S155	
19	108961 SPRING, compression, 1 156 dia. shaft, Guns 24S134, 24S135, 24S155		15D930	Gun 248093	1
20	103610 PACKING, o-ring	1	41	119343 RING, retaining	1
21	15C896 RETAINER, spring, air valve	1	46	17E200 HOUSING, adapter	1
22	17H665 VALVE, ball	1	47	17H637 RING, retaining	1
23	17J436 ASSEMBLY, prime 1 valve, 156 dia. shaft, Guns 24S134, 24S135, 24S155		24S142	KIT, accessory, WideTex 1 <i>includes 46, 47, nozzles W4, W6, W8, W10, W12, WXL</i>	
23a	17K135 FITTING, air, line, Gun 1 248093		24S143	KIT, accessory, WideTex 1 <i>includes 46, 47, nozzles W4H, W6H, W8H, W10H, W12H, WXLH</i>	

# Technical Specifications

## Technical Specifications

	US	Metric
<b>Spray Gun</b>		
Maximum Fluid Working Pressure		
Non-bleeder gun	125 psi	8.6 bar, 0.9 MPa
Bleeder gun	125 psi	8.6 bar, 0.9 MPa
Maximum Air Working Pressure	125 psi	8.6 bar, 0.9 MPa
Air Requirements (maximum)	30 scfm	0.84m <sup>3</sup> /min
Fluid Inlet Size	1 in. NPT	25.4 mm
<b>Dimensions</b>		
Height	10.3 in.	262 mm
Length	7.5 in.	191 mm
Width	1.7 in.	43 mm
Weight (dry)	2.3 lb.	1.0 kg
<b>Noise**</b>		
Sound Pressure Level	80.8 dBa*	
Sound Power Level	96.5 dBa*	
<b>Materials of Construction</b>		
Wetted materials on all models	Anodized Aluminum, Stainless Steel, Buna-N, UHMW Polyethylene, Brass, Steel, Viton, Delrin	
<b>Notes</b>		
* Spraying simulated acoustic at full air and maximum material pressure.		
** Sound pressure measured 3 feet (1 meter) from equipment while spraying. Sound power measured per ISO-9614.		



## Graco Standard Warranty

Graco warrants all equipment referenced in this document which is manufactured by Graco and bearing its name to be free from defects in material and workmanship on the date of sale to the original purchaser for use. With the exception of any special, extended, or limited warranty published by Graco, Graco will, for a period of twelve months from the date of sale, repair or replace any part of the equipment determined by Graco to be defective. This warranty applies only when the equipment is installed, operated and maintained in accordance with Graco's written recommendations.

This warranty does not cover, and Graco shall not be liable for general wear and tear, or any malfunction, damage or wear caused by faulty installation, misapplication, abrasion, corrosion, inadequate or improper maintenance, negligence, accident, tampering, or substitution of non-Graco component parts. Nor shall Graco be liable for malfunction, damage or wear caused by the incompatibility of Graco equipment with structures, accessories, equipment or materials not supplied by Graco, or the improper design, manufacture, installation, operation or maintenance of structures, accessories, equipment or materials not supplied by Graco.

This warranty is conditioned upon the prepaid return of the equipment claimed to be defective to an authorized Graco distributor for verification of the claimed defect. If the claimed defect is verified, Graco will repair or replace free of charge any defective parts. The equipment will be returned to the original purchaser transportation prepaid. If inspection of the equipment does not disclose any defect in material or workmanship, repairs will be made at a reasonable charge, which charges may include the costs of parts, labor, and transportation.

**THIS WARRANTY IS EXCLUSIVE, AND IS IN LIEU OF ANY OTHER WARRANTIES, EXPRESS OR IMPLIED, INCLUDING BUT NOT LIMITED TO WARRANTY OF MERCHANTABILITY OR WARRANTY OF FITNESS FOR A PARTICULAR PURPOSE.**

Graco's sole obligation and buyer's sole remedy for any breach of warranty shall be as set forth above. The buyer agrees that no other remedy (including, but not limited to, incidental or consequential damages for lost profits, lost sales, injury to person or property, or any other incidental or consequential loss) shall be available. Any action for breach of warranty must be brought within two (2) years of the date of sale.

**GRACO MAKES NO WARRANTY, AND DISCLAIMS ALL IMPLIED WARRANTIES OF MERCHANTABILITY AND FITNESS FOR A PARTICULAR PURPOSE, IN CONNECTION WITH ACCESSORIES, EQUIPMENT, MATERIALS OR COMPONENTS SOLD BUT NOT MANUFACTURED BY GRACO.** These items sold, but not manufactured by Graco (such as electric motors, switches, hose, etc.), are subject to the warranty, if any, of their manufacturer. Graco will provide purchaser with reasonable assistance in making any claim for breach of these warranties.

In no event will Graco be liable for indirect, incidental, special or consequential damages resulting from Graco supplying equipment hereunder, or the furnishing, performance, or use of any products or other goods sold hereto, whether due to a breach of contract, breach of warranty, the negligence of Graco, or otherwise.

### **FOR GRACO CANADA CUSTOMERS**

The Parties acknowledge that they have required that the present document, as well as all documents, notices and legal proceedings entered into, given or instituted pursuant hereto or relating directly or indirectly hereto, be drawn up in English. Les parties reconnaissent avoir convenu que la rédaction du présente document sera en Anglais, ainsi que tous documents, avis et procédures judiciaires exécutés, donnés ou intentés, à la suite de ou en rapport, directement ou indirectement, avec les procédures concernées.

# Graco Information

For the latest information about Graco products, visit [www.graco.com](http://www.graco.com).

For patent information, see [www.graco.com/patents](http://www.graco.com/patents).

**TO PLACE AN ORDER**, contact your Graco distributor or call 1-800-690-2894 to identify the nearest distributor.



*All written and visual data contained in this document reflects the latest product information available at the time of publication.*

*Graco reserves the right to make changes at any time without notice.*

Original instructions. This manual contains English. MM 3A3373

**Graco Headquarters:** Minneapolis

**International Offices:** Belgium, China, Japan, Korea

**GRACO INC. AND SUBSIDIARIES • P.O. BOX 1441 • MINNEAPOLIS MN 55440-1441 • USA**

**Copyright 2016, Graco Inc. All Graco manufacturing locations are registered to ISO 9001.**

[www.graco.com](http://www.graco.com)

Revision C, May 2019