

Contractor PC Spray Guns

3A6285L

EN

For the application of architectural paints and coatings. For professional use only.

3600 psi (24.8 MPa, 248 bar) Maximum Working Pressure

See page 2 for additional model information.



Important Safety Instructions

Read all warnings and instructions in this manual. Refer to your sprayer instruction manual for Pressure Relief, priming and spray instructions. Save these instructions.



Important Medical Information

Read the medical alert card provided with the gun. It contains injection injury treatment information for a doctor. Keep it with you when operating the equipment.

Contractor PC Gun

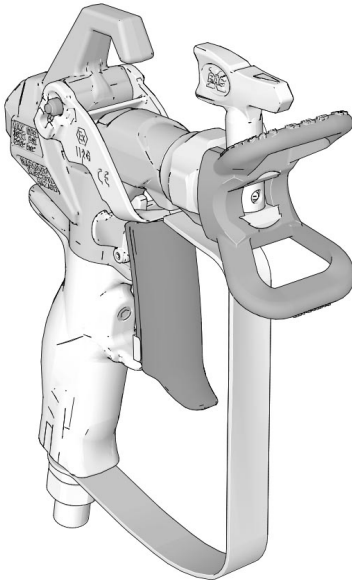

Contractor PC Compact Gun

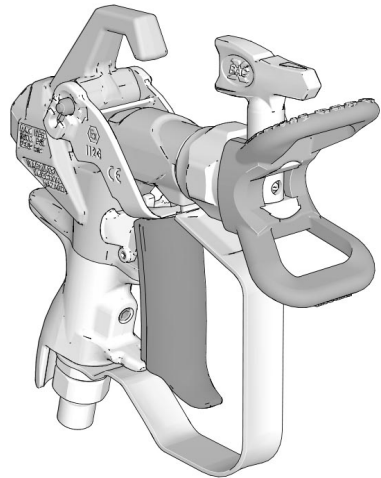

ti34244b



II 2 G Ex h IIA T6 Gb

PROVEN QUALITY. LEADING TECHNOLOGY.



Contents



Models	2
Warnings	3
Grounding	5
Setup	6
Pressure Relief Procedure	6
Gun Trigger Lock	6
Trigger Adjustment (Contractor PC Gun only)	7
Install Tip and Tip Guard on Gun	8
Connect Gun to Sprayer	8
Operation	9
Aligning Spray	9
Spraying	9
Clear Spray Tip Clog	9
Cleanup	9
Parts	10
Tip and Guard	11
Maintenance	12
Cleaning/Replacing Filter	12
Repair/Replacement	13
Replacing Cartridge	13
Aligning Handle	14
Technical Specifications	15
California Proposition 65	15
Graco Standard Warranty	16
Graco Information	17

Models

Contractor PC Gun Models				
Part No.	Tip(s)	Guard	Filter	Language Translation Included
17Y042	LTX517	RAC X	60 Mesh	English, French, Spanish
17Y043	LP517	RAC X	60 Mesh	English, French, Spanish, German
17Y044	LTX517	RAC X	60 Mesh	English, Chinese, Japanese, Korean
17Y045	None	RAC X	60 Mesh	English, French, Spanish, German
17Y470	FFLP210	RAC X	100 Mesh	English, French, Spanish
826252	LTX517 + LP517	RAC X	60 Mesh	English, French, Spanish
17Z644	LTX515	RAC X	60 Mesh	English, French, Spanish
826291	LP517	RAC X	60 Mesh	English, French, Spanish
26D846	LP517	RAC X	60 Mesh	English, Chinese, Japanese, Korean
Contractor PC Compact Gun Models				
19Y349	LTX517	RAC X	60 Mesh	English, French, Spanish
19Y350	LP517	RAC X	60 Mesh	English, French, Spanish, German
19Y443	FFLP210	RAC X	100 Mesh	English, French, Spanish, German
826261	LTX517 + LP517	RACX	60 Mesh	English, French, Spanish

Warnings

The following warnings are for the setup, use, grounding, maintenance, and repair of this equipment. The exclamation point symbol alerts you to a general warning and the hazard symbols refer to procedure-specific risks. When these symbols appear in the body of this manual or on warning labels, refer back to these Warnings. Product-specific hazard symbols and warnings not covered in this section may appear throughout the body of this manual where applicable.

 WARNING	
	<p>SKIN INJECTION HAZARD</p> <p>High-pressure fluid from gun, hose leaks, or ruptured components will pierce skin. This may look like just a cut, but it is a serious injury that can result in amputation. Get immediate surgical treatment.</p> <ul style="list-style-type: none"> • Do not spray without tip guard and trigger guard installed. • Engage trigger lock when not spraying. • Do not point gun at anyone or at any part of the body. • Do not put your hand over the spray tip. • Do not stop or deflect leaks with your hand, body, glove, or rag. • Follow the Pressure Relief Procedure when you stop spraying and before cleaning, checking, or servicing equipment. • Tighten all fluid connections before operating the equipment. • Check hoses and couplings daily. Replace worn or damaged parts immediately.
	<p>FIRE AND EXPLOSION HAZARD</p> <p>Flammable fumes, such as solvent and paint fumes, in work area can ignite or explode. Paint or solvent flowing through the equipment can cause static sparking. To help prevent fire and explosion:</p> <ul style="list-style-type: none"> • Use equipment only in well ventilated area. • Eliminate all ignition sources; such as pilot lights, cigarettes, portable electric lamps, and plastic drop cloths (potential static sparking). • Ground all equipment in the work area. See Grounding instructions. • Never spray or flush solvent at high pressure. • Keep work area free of debris, including solvent, rags and gasoline. • Do not plug or unplug power cords, or turn power or light switches on or off when flammable fumes are present. • Use only grounded hoses. • Hold gun firmly to side of grounded pail when triggering into pail. Do not use pail liners unless they are anti-static or conductive. • Stop operation immediately if static sparking occurs or you feel a shock. Do not use equipment until you identify and correct the problem. • Keep a working fire extinguisher in the work area.

Warnings

WARNING



EQUIPMENT MISUSE HAZARD

Misuse can cause death or serious injury.

- Always wear appropriate gloves, eye protection, and a respirator or mask when painting.
- Do not operate or spray near children. Keep children away from equipment at all times.
- Do not overreach or stand on an unstable support. Keep effective footing and balance at all times.
- Stay alert and watch what you are doing.
- Do not operate the unit when fatigued or under the influence of drugs or alcohol.
- Do not kink or over-bend the hose.
- Do not expose the hose to temperatures or to pressures in excess of those specified by Graco.
- Do not use the hose as a strength member to pull or lift the equipment.
- Do not spray with a hose shorter than 25 feet.
- Do not alter or modify equipment. Alterations or modifications may void agency approvals and create safety hazards.
- Make sure all equipment is rated and approved for the environment in which you are using it.



PRESSURIZED ALUMINUM PARTS HAZARD

Use of fluids that are incompatible with aluminum in pressurized equipment can cause serious chemical reaction and equipment rupture. Failure to follow this warning can result in death, serious injury, or property damage.

- Do not use 1,1,1-trichloroethane, methylene chloride, other halogenated hydrocarbon solvents or fluids containing such solvents.
- Do not use chlorine bleach.
- Many other fluids may contain chemicals that can react with aluminum. Contact your material supplier for compatibility.





PERSONAL PROTECTIVE EQUIPMENT

Wear appropriate protective equipment when in the work area to help prevent serious injury, including eye injury, hearing loss, inhalation of toxic fumes, and burns. This protective equipment includes but is not limited to:

- Protective eyewear, and hearing protection.
- Respirators, protective clothing, and gloves as recommended by the fluid and solvent manufacturer.

Grounding

				
--	---	---	--	--

The equipment must be grounded to reduce the risk of static sparking. Static sparking can cause fumes to ignite or explode. Grounding provides an escape wire for the electric current.

Spray Gun: ground through connection to a properly grounded fluid hose and pump.

Fluid Supply Container: follow local code.

Solvent Pails Used when Flushing: follow local code. Use only conductive metal pails, placed on a grounded surface. Do not place the pail on a nonconductive surface, such as paper or cardboard, which interrupts grounding continuity.



Ground Metal Pails: Connect a ground wire to the pail by clamping one end to the pail and the other end to a ground such as a water pipe.

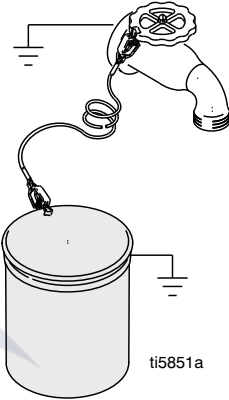

Maintain Grounding Continuity: When flushing or relieving pressure, hold a metal part of the gun firmly against the side of a grounded metal pail, then trigger the gun.

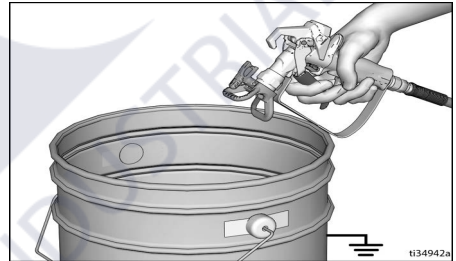

Fluid Hose: use only electrically conductive hoses with a maximum of 500 ft. (150 m) combined hose length to ensure grounding continuity. Check electrical resistances of hoses. If total resistance to ground exceeds 29 megohms, replace hose immediately.

Setup

Pressure Relief Procedure



Follow the Pressure Relief Procedure whenever you see this symbol.

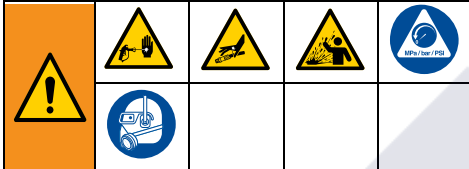

This equipment stays pressurized until pressure is manually relieved. To help prevent serious injury from pressurized fluid, such as skin injection or splashed fluid, follow the **Pressure Relief Procedure** whenever sprayer is stopped and before sprayer is cleaned or checked, and before equipment is serviced.

1. Turn sprayer **OFF**.
2. Engage the trigger lock. Always engage the trigger lock when sprayer is stopped to prevent the gun from being triggered accidentally.
3. Turn pressure control knob to lowest setting.
4. Put drain tube into a waste pail and turn Prime/Spray valve in PRIME position (drain) to relieve pressure.
5. Hold the gun firmly to a pail. Point gun into pail. Disengage the trigger lock and trigger the gun to relieve pressure.

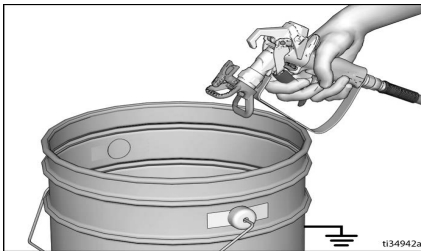

6. Engage the trigger lock.

7. If you suspect the spray tip or hose is clogged or that pressure has not been fully relieved:
 - a. **VERY SLOWLY** loosen the tip guard retaining nut or the hose end coupling to relieve pressure gradually.
 - b. Loosen the nut or coupling completely.
 - c. Clear airless hose or spray tip obstruction. See **Clear Spray Tip Clog**, page 9.

Gun Trigger Lock



To prevent injury when the gun is not in use, always engage the gun's trigger lock if unit is being shut down or left unattended.



ti34248a

Trigger Adjustment (Contractor PC Gun only)

The trigger can be adjusted to different lengths depending upon user preference.

1. Relieve pressure. See **Pressure Relief Procedure**, page 6.
2. Loosen adjustment knob (13c). Use a flat blade screwdriver or coin if the knob (13c) cannot be loosened by hand. Complete one full turn to loosen the adjustment knob. Three full turns could result in the adjustment knob falling out.
3. Hold end of trigger (13b) and slide to desired position.

NOTE: Hold trigger in location shown when adjusting.

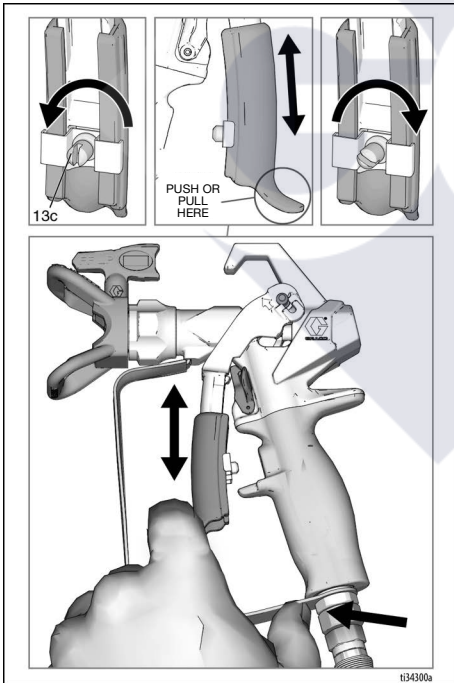

4. Tighten adjustment knob (13c) firmly.

NOTE: If trigger is too difficult to slide, use a flat blade screwdriver to slide it down and apply grease to the location shown.

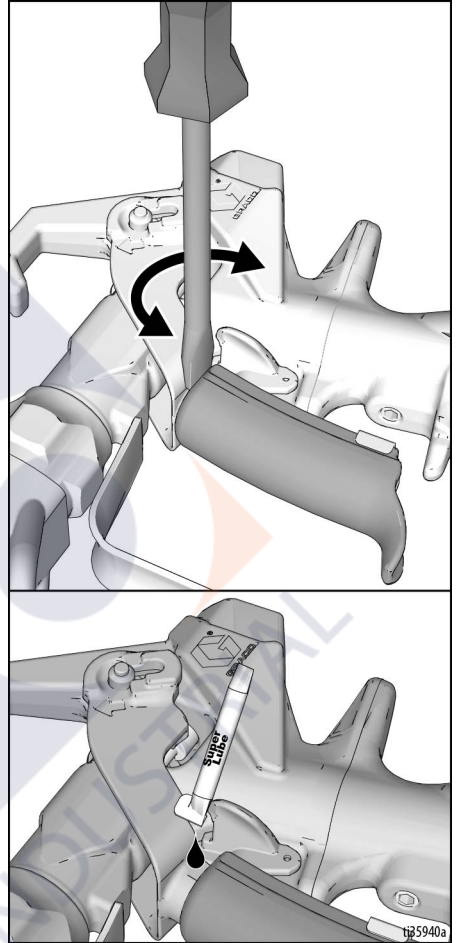

Setup

Install Tip and Tip Guard on Gun



To avoid serious injury from skin injection do not put your hand in front of the spray tip when installing or removing the spray tip and tip guard.

NO

YES

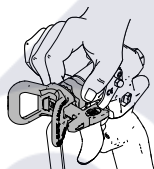

To prevent spray tip leaks make certain spray tip and tip guard are installed properly.

1. Relieve pressure. See **Pressure Relief Procedure**, page 6. Engage trigger lock (15).
2. Use spray tip (26) to align gasket and seal (24) in the tip guard (25).

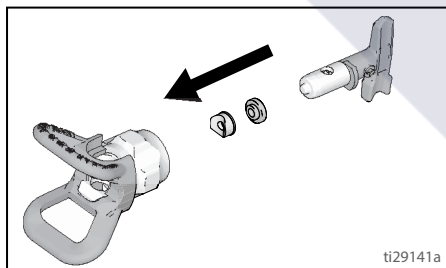

3. Insert tip (26) in guard (25).

4. Verify spray tip and tip guard parts are assembled in the order shown.

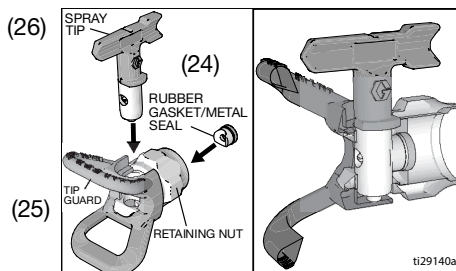

5. Install guard (25) over end of gun (1). Hand tighten retaining nut.

Connect Gun to Sprayer

Make sure sprayer is turned off and unplugged from power source. Refer to your sprayer instruction manual for priming and spray instructions.

1. Attach supply hose to sprayer fluid outlet.
2. Attach other end of supply hose to gun swivel (7). Use two wrenches (one on the swivel (7) and one on the hose), to tighten all connections securely.
3. Refer to sprayer instruction manual for priming instructions.

Operation



Aligning Spray

1. Relieve pressure. See **Pressure Relief Procedure**, page 6. Engage trigger lock (15).
2. Loosen guard (25) retaining nut.
3. Align guard (25) horizontally to spray a horizontal pattern or vertically to spray a vertical pattern.

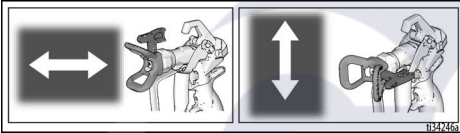

4. Hand tighten guard (25) retaining nut when you have adjusted to desired setting.

Spraying

1. Disengage trigger lock (15).
2. Be sure the arrow shaped tip (26) faces forward (spray).
3. Hold gun perpendicular and approximately 12 inches (304 mm) from surface. Move gun first, then pull gun trigger (13) to spray a test pattern.
4. Slowly increase pump pressure until coverage is uniform and even (see sprayer instruction manual for additional information).

Clear Spray Tip Clog

In the event that particles or debris clog the spray tip, this gun is designed with a reversible spray tip that quickly and easily clears the particles without disassembling the sprayer.

1. Engage trigger lock (15). Rotate spray tip (26) to unclog position. Disengage trigger lock (15). Trigger gun at waste area to clear clog.

NOTE: If spray tip (26) is difficult to rotate when turning to the unclog position, perform **Pressure Relief Procedure**, page 6, then turn Prime/Spray valve to spray position and repeat step 1.

2. Engage trigger lock (15). Rotate spray tip (26) back to spray position. Disengage trigger lock (15) and continue spraying.

Cleanup

Flush gun, clean filter (see **Cleaning/Replacing Filter** on page 12) and clean paint off the outside after each work shift. Store in a dry location. Refer to your sprayer manual for flushing instructions. Do not leave the gun or any parts in water or cleaning solvents.

NOTICE

To prevent damage to the gun parts, do not leave the gun or any parts, except the tip, in water or cleaning solvents. The gun is **NOT** compatible with cleaning solvents that contain methylene chloride.

Parts

Contractor PC

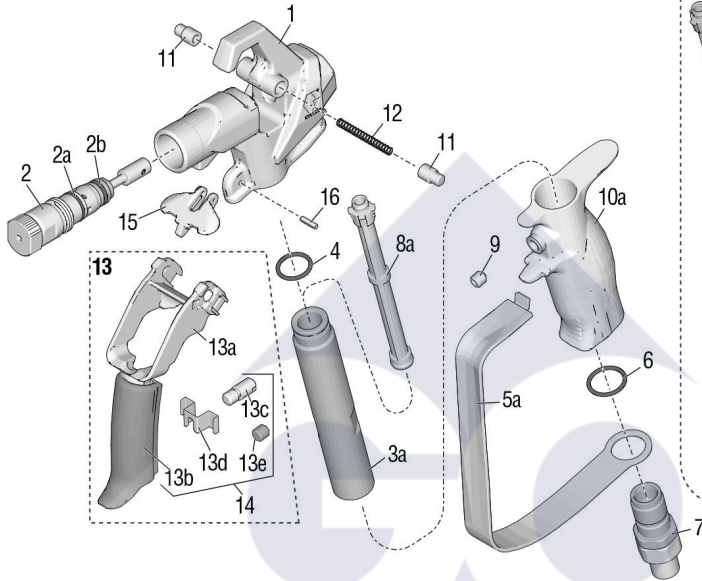

Contractor PC Compact

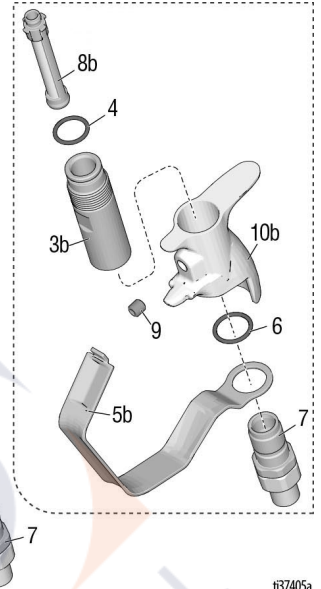

137405a

Ref. Part	Description	Qty	Ref. Part	Description	Qty
1	17X496 HOUSING, assy Includes 15, 16	1	11	17V288 PIN, trigger	2
2	17Y297 KIT, repair, cartridge, <i>includes</i> 2a, 2b	1	12	17V766 SPRING, compression	1
2a	17W752 PACKING, o-ring	1	13	17Y466 TRIGGER, Contractor PC, assy <i>includes</i> 11, 12, 13a, 13b, 13c, 13d	1
2b	16H931 PACKING, o-ring	1	19Y440	TRIGGER, Compact, assy <i>includes</i> 11, 12, 13a, 13b, 13e	1
3a	17T073 TUBE, handle, Contractor PC	1	13a	TRIGGER, upper	1
3b	19Y272 TUBE, handle, Compact	1	13b	TRIGGER, lower	1
4	120776 PACKING, o-ring	1	13c	KNOB, adjustment	1
5a	17V395 GUARD, trigger, Contractor PC	1	13d	CLIP, trigger	1
5b	19Y270 GUARD, trigger, Compact	1	13e	SCREW, set	1
6	120733 O-RING, urethane, clear	1	14	17Z690 TRIGGER, Contractor PC, repair <i>includes</i> 13b, 13c, 13d	1
7	288811 SWIVEL, assy, gun	1	19Y512	TRIGGER, Compact, repair <i>includes</i> 13b, 13e	1
8a	17V395 FILTER, gun, Contractor PC	1	15	17V767 LOCK, trigger	1
	287032 60 mesh		16	17Y024 PIN, spring	1
	287033 100 mesh		20	119799 BRUSH, cleaning (not shown)	1
	287034 60 and 100 mesh combo		21▲	222385 CARD, medical alert (not shown)	1
8b	19Y355 FILTER, gun, Compact	1			
	19Y356 60 mesh				
	19Y357 100 mesh				
	19Y358 60 and 100 mesh combo				
9	17Y226 SCREW, set	1			
10a	17T030 HANDLE, gun, Contractor PC	1			
10b	19Y376 HANDLE, gun, Compact	1			

▲ Replacement safety labels, tags and cards are available at no cost.

Tip and Guard

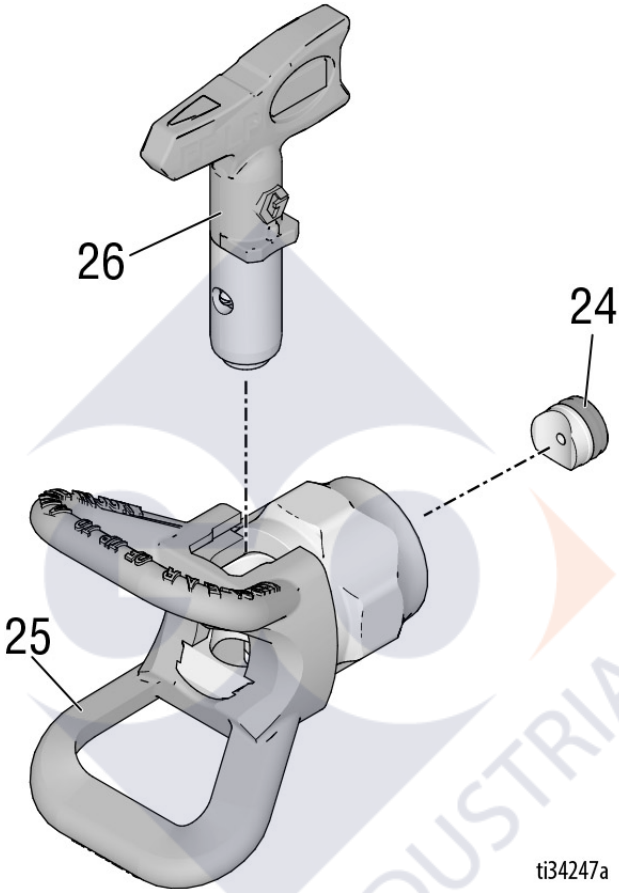

ti34247a

Ref.Part	Description	Qty	Ref.Part	Description	Qty
24	246453 OneSeal™, RAC X (5-pack)	1		Models: 17Y043, 826252,	
	248936 KIT, SOLVENT, RAC X	1		19Y350, 826261, 26D846,	
	17P501 OneSeal™, FFLP, LP	1		826291	
	17P502 KIT, SOLVENT, FFLP, LP	1	FFLP210	TIP, spray, 210 FFLP	1
25	246215 GUARD, RAC X	1		Models: 17Y470, 19Y443	
26†	TIP, spray	1			
	LTX517 TIP, spray 517, RAC X	1			
	Models: 17Y042, 17Y044,				
	826252, 19Y349, 826261				
	LTX515 TIP, spray 515, RAC X	1			
	Model: 17Z644				
	LP517 TIP, spray 517, LP	1			

† For a list of all available tip sizes, talk to your local distributor or visit www.graco.com.

Maintenance



To avoid serious injury from skin injection, follow the **Pressure Relief Procedure** before performing any maintenance on the gun.

Cleaning/Replacing Filter

A plugged filter reduces gun performance. Clean filter after each use.

1. Relieve pressure. See **Pressure Relief Procedure**, page 6.
2. Disconnect fluid hose from gun at swivel (7).
3. Disconnect trigger guard (5) from housing (1) as shown.

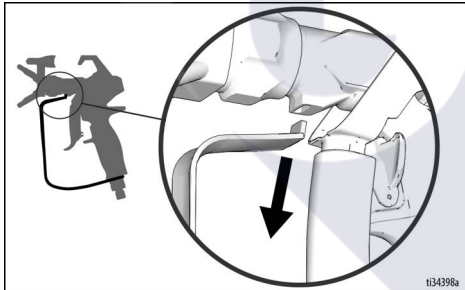

4. Engage trigger lock (15).
5. **Contractor PC:** Unscrew handle (10) from housing (1).

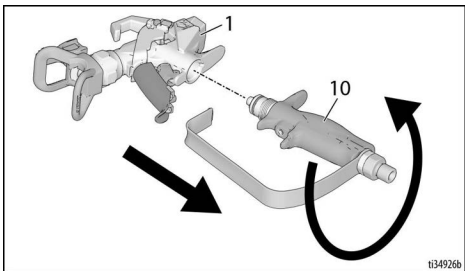

Contractor PC Compact: Unscrew handle (10) from housing (1) using guard (5).

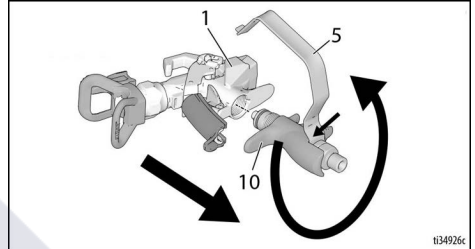

6. Remove filter (8) through top of handle (10).
7. Clean filter (8). Use a soft brush to loosen and remove excess debris.
8. Inspect filter (8) for damage to the filter mesh. Replace the filter if the filter mesh has holes or voids.
9. Inspect handle tube (3) for damage. Replace if it is corroded or pitted and check material for compatibility with aluminum.
10. Inspect o-ring (4) and replace if necessary.
11. Insert clean filter (8) into handle (10).
12. Reattach handle (10) to housing (1). Tighten securely.
13. Disengage trigger lock (15).
14. Reconnect trigger guard (5) into the slot in the housing (1) as shown.

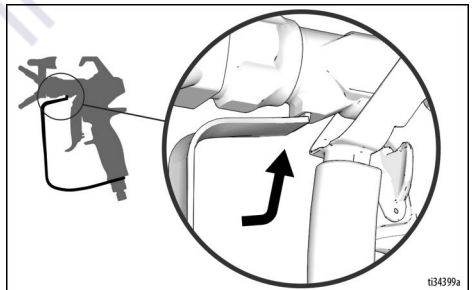

15. Engage trigger lock.

Repair/Replacement

				
--	---	---	---	---

To avoid serious injury from skin injection, follow the **Pressure Relief Procedure** before repairing the gun.

Replacing Cartridge

Replace cartridge if the assembly is leaking or if there is a loss in spray performance that cannot be resolved by flushing the gun.

1. Relieve pressure. See **Pressure Relief Procedure**, page 6.
2. Engage trigger lock (15).
3. Remove tip (26) and guard (25) from gun (1).
4. Disengage trigger lock (15).
5. Depress 2 pins (11) and pull trigger assembly (13) up into repair position as shown.

NOTICE

Never attempt to remove the cartridge unless the trigger assembly (13) is in the repair position --- cartridge will not come out. If cartridge is left partially removed, the gun will not operate properly.

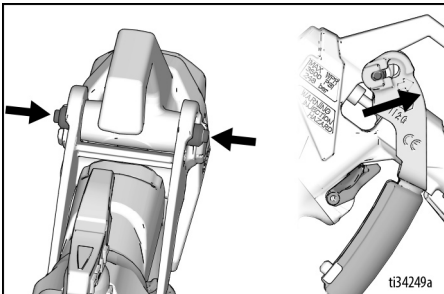

6. Unscrew cartridge (2) from front of gun (1).

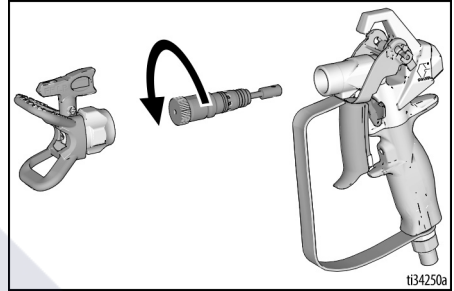

NOTE: If it is too difficult to remove by hand, use a 1/8" allen wrench or 5/8 wrench (if your cartridge has flats) to break loose as shown.

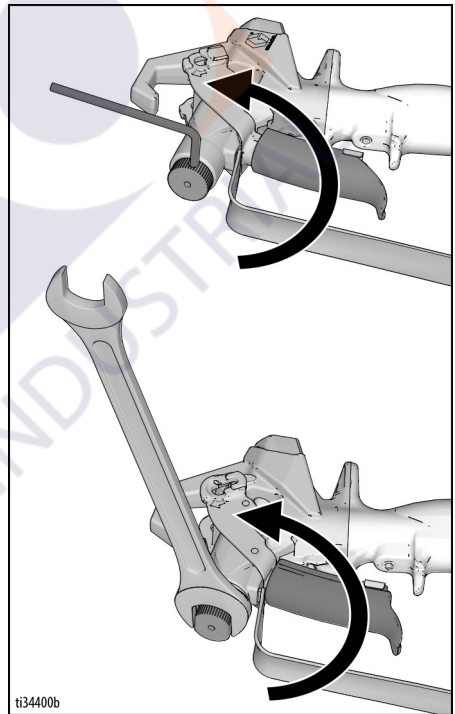

7. Use a soft brush to clean out internal passages of gun.

Repair/Replacement

8. Install new cartridge (2) into the gun and torque to 150 in-lbs (17.0 N-m). There should be no gap in the indicated area below (a).

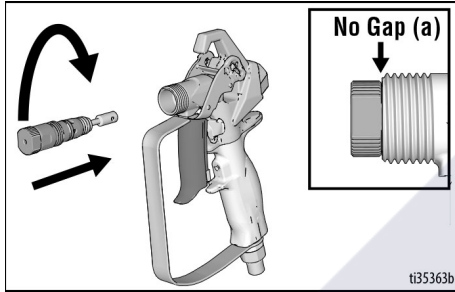

9. Push trigger assembly (13) back down into spray position. The push pins (11) should snap back out to normal position when trigger assembly (13) is fully engaged. Verify the cartridge is installed correctly by making sure the trigger assembly (13) can wiggle back and forth.

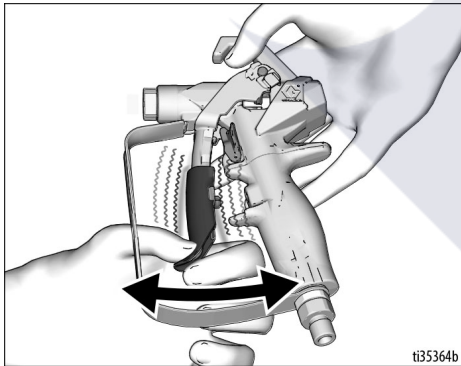

NOTE: Do not operate the gun if the cartridge is not installed correctly.

10. Reinstall tip (26) and guard (25).

Aligning Handle

If when tightened securely, handle no longer matches up with housing, realign handle.

1. Relieve pressure. See **Pressure Relief Procedure**, page 6. Engage trigger lock (15).
2. Tighten handle (10) securely.
3. Loosen set screw (9) using a 1/8" allen wrench.
4. Rotate handle (10) so it is aligned with housing (1).
5. Tighten set screw (9) securely.

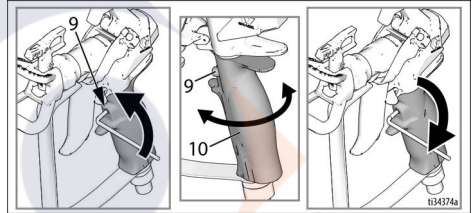

Technical Specifications

Maximum working pressure	3600 psi (248 bar, 24.8 MPa)	
Fluid orifice size	0.120 in. (3.05 mm)	
Inlet	1/4 NPSM swivel	
Maximum material temperature	120° F (49° C)	
Wetted Parts	Stainless steel, aluminum, tungsten carbide, solvent resistant elastomer, UHMwpE, acetal	
Weight		
Gun	Without Tip and Guard	With Tip and Guard
Contractor	21.2 oz (601 g)	23.8 oz (675 g)
Contractor PC - A	17.4 oz (493 g)	20.0 oz (567 g)
Contractor PC - B	18.8 oz (533 g)	21.4 oz (607 g)
Contractor PC Compact	16.1 oz (456 g)	18.7 oz (530 g)
Noise Level*		
Sound power	87 dBa	
Sound pressure	78 dBa	
* Measured at 3.1 feet (1m) while spraying water-based paint, specific gravity 1.36, through a 517 tip at 3000 psi (207 bar, 20.7 MPa) per ISO 3744.		

California Proposition 65

CALIFORNIA RESIDENTS

 **WARNING:** Cancer and reproductive harm – www.P65warnings.ca.gov.

Translated Manuals

3A6289	Spanish	3A6303	Latvian
3A6290	French	3A6304	Lithuanian
3A6291	Dutch	3A6305	Polish
3A6292	Italian	3A6306	Hungarian
3A6293	Turkish	3A6307	Czech
3A6294	Greek	3A6308	Slovakian
3A6295	Croatian	3A6309	Slovenian
3A6296	Portuguese	3A6310	Romanian
3A6297	Danish	3A6311	Bulgarian
3A6298	Finnish	3A6312	Chinese
3A6299	Swedish	3A6313	Japanese
3A6300	Norwegian	3A6314	Korean
3A6301	Russian	3A6318	German
3A6302	Estonian	3A7498	Hindi
		3A7499	Indonesian

Translated manuals can be requested through a distributor or at www.graco.com.

Graco Standard Warranty

Graco Standard Warranty

Graco warrants all equipment referenced in this document which is manufactured by Graco and bearing its name to be free from defects in material and workmanship on the date of sale to the original purchaser for use. With the exception of any special, extended, or limited warranty published by Graco, Graco will, for a period of twelve months from the date of sale, repair or replace any part of the equipment determined by Graco to be defective. This warranty applies only when the equipment is installed, operated and maintained in accordance with Graco's written recommendations.

This warranty does not cover, and Graco shall not be liable for general wear and tear, or any malfunction, damage or wear caused by faulty installation, misapplication, abrasion, corrosion, inadequate or improper maintenance, negligence, accident, tampering, or substitution of non-Graco component parts. Nor shall Graco be liable for malfunction, damage or wear caused by the incompatibility of Graco equipment with structures, accessories, equipment or materials not supplied by Graco, or the improper design, manufacture, installation, operation or maintenance of structures, accessories, equipment or materials not supplied by Graco.

This warranty is conditioned upon the prepaid return of the equipment claimed to be defective to an authorized Graco distributor for verification of the claimed defect. If the claimed defect is verified, Graco will repair or replace free of charge any defective parts. The equipment will be returned to the original purchaser transportation prepaid. If inspection of the equipment does not disclose any defect in material or workmanship, repairs will be made at a reasonable charge, which charges may include the costs of parts, labor, and transportation.

THIS WARRANTY IS EXCLUSIVE, AND IS IN LIEU OF ANY OTHER WARRANTIES, EXPRESS OR IMPLIED, INCLUDING BUT NOT LIMITED TO WARRANTY OF MERCHANTABILITY OR WARRANTY OF FITNESS FOR A PARTICULAR PURPOSE.

Graco's sole obligation and buyer's sole remedy for any breach of warranty shall be as set forth above. The buyer agrees that no other remedy (including, but not limited to, incidental or consequential damages for lost profits, lost sales, injury to person or property, or any other incidental or consequential loss) shall be available. Any action for breach of warranty must be brought within two (2) years of the date of sale.

GRACO MAKES NO WARRANTY, AND DISCLAIMS ALL IMPLIED WARRANTIES OF MERCHANTABILITY AND FITNESS FOR A PARTICULAR PURPOSE, IN CONNECTION WITH ACCESSORIES, EQUIPMENT, MATERIALS OR COMPONENTS SOLD BUT NOT MANUFACTURED BY GRACO. These items sold, but not manufactured by Graco (such as electric motors, switches, hose, etc.), are subject to the warranty, if any, of their manufacturer. Graco will provide purchaser with reasonable assistance in making any claim for breach of these warranties.

In no event will Graco be liable for indirect, incidental, special or consequential damages resulting from Graco supplying equipment hereunder, or the furnishing, performance, or use of any products or other goods sold hereto, whether due to a breach of contract, breach of warranty, the negligence of Graco, or otherwise.

FOR GRACO CANADA CUSTOMERS

The Parties acknowledge that they have required that the present document, as well as all documents, notices and legal proceedings entered into, given or instituted pursuant hereto or relating directly or indirectly hereto, be drawn up in English. Les parties reconnaissent avoir convenu que la rédaction du présent document sera en Anglais, ainsi que tous documents, avis et procédures judiciaires exécutés, donnés ou intentés, à la suite de ou en rapport, directement ou indirectement, avec les procédures concernées.

Graco Information

For the latest information about Graco products, visit www.graco.com.

For patent information, see www.graco.com/patents.

TO PLACE AN ORDER, contact your Graco distributor or call 1-800-690-2894 to identify the nearest distributor.





All written and visual data contained in this document reflects the latest product information available at the time of publication.

Graco reserves the right to make changes at any time without notice.

Original instructions. This manual contains English. MM 3A6285

Graco Headquarters: Minneapolis

International Offices: Belgium, China, Japan, Korea

GRACO INC. AND SUBSIDIARIES • P.O. BOX 1441 • MINNEAPOLIS MN 55440-1441 • USA

Copyright 2018, Graco Inc. All Graco manufacturing locations are registered to ISO 9001.

www.graco.com

Revision L, July 2023