

Includes models

K53-01

K54-01

K53 & K54 AIR OPERATED POWER PISTOL



INSTRUCTION MANUAL

Introduction

Thank you for purchasing a Macnaught air operated Power Pistol.

The Macnaught Power Pistol models K53(450g) and K54 (400g) are single shot air operated grease guns, suitable for bulk, cartridge or grease pump filling with greases up to and including NLGI No.2 consistency.

A wide range of Macnaught greasing accessories including Flexible Extensions, Needle Point Couplers, Adaptors and Button Head Couplers are available from your Macnaught dealer.

Please read and retain this instruction sheet to assist you in assembly and maintenance of this product.



OPERATION

The Power-Pistol injects a single shot of grease at each pull of the trigger, enabling the user to control the amount of grease delivered. The trigger must be completely pulled back to achieve maximum pressure. Exhaust air will exit behind the trigger.



CAUTION

Always disconnect the air supply line before servicing.

SELECT FOLLOWER POSITION

Note:
Refer to Fig 1 for the correct follower position.

How to select Follower position

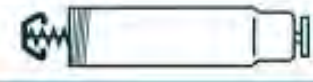
Grease	Follower Position
Bulk	 Push ←
Cart-ridge	 Push ←

(Fig 1)

HOW TO BULK FILL BY SUCTION

Note: Select the correct follower position (see Fig 1).

- 1) Lock follower (Fig 2).
- 2) Unscrew the barrel from the gun body 2 to 3 turns.
- 3) Pull the rod back and retain in barrel slot (Fig.3)
- 4) Unscrew the barrel from the gun body.
- 5) Release the follower rod from the barrel slot.
- 6) Insert the open end of the barrel into the grease, pull the rod back slowly, and at the same time push the barrel into the grease. Pull back the rod until the groove in the rod appears then push the rod into the barrel slot.
- 7) Wipe clean and screw the gun body assembly onto the barrel.
- 8) Unlock the follower rod from the barrel and apply light pressure on the pull handle (Fig.5), at the same time press the ball in the filler bleeder until grease appears.
- 9) Connect the air and pull the trigger several times. If grease does not appear at the coupler repeat step 8.
- 10) Unlock the follower rod and push the rod into the barrel.

Note: Should the gun fail to deliver grease refer to the Trouble Shooting Guide on page 3.

How to lock Follower

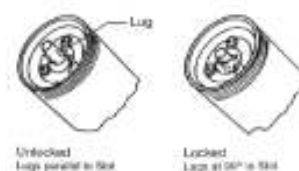

(Fig 2)



(Fig 3)

FAST FILLING WITH A J3 GREASE PUMP

Note: Select the correct follower position (see Fig 1).

- 1) Lock the follower rod (Fig 2).
- 2) Slide the filler bleeder valve into the nozzle on the pump (Fig 4).
- 3) Fill with grease until the groove in the rod is visible at the end of the barrel.
- 4) Repeat steps (8), (9), (10) refer (How to bulk Fill).

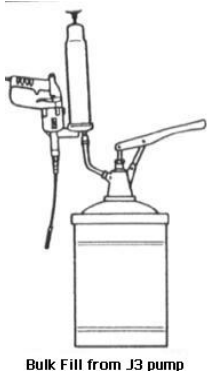

Bulk Fill from J3 pump

(Fig 4)

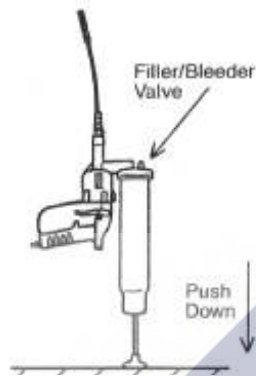

(Fig 5)

HOW TO INSTAL A CARTRIDGE

Note: Select the correct follower position (see Fig 1).

Repeat steps (1) to (2) above

- 1) Pull the follower rod back until the rod groove can be pulled into the barrel slot.
- 2) Remove the large end cap from the cartridge.
- 3) Slide the large open end first into the barrel.
- 4) Remove the small end cap from the cartridge.
- 5) Screw the gun body assembly onto the barrel.
- 6) Repeat steps (8), (9), (10) as above.

How to remove the KY coupler from the grease nipple.

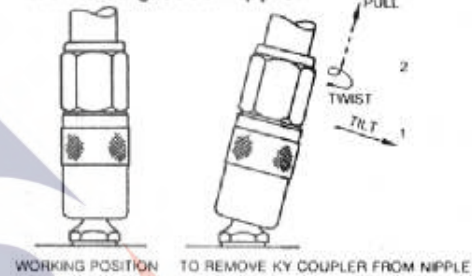

PARTS DIAGRAM

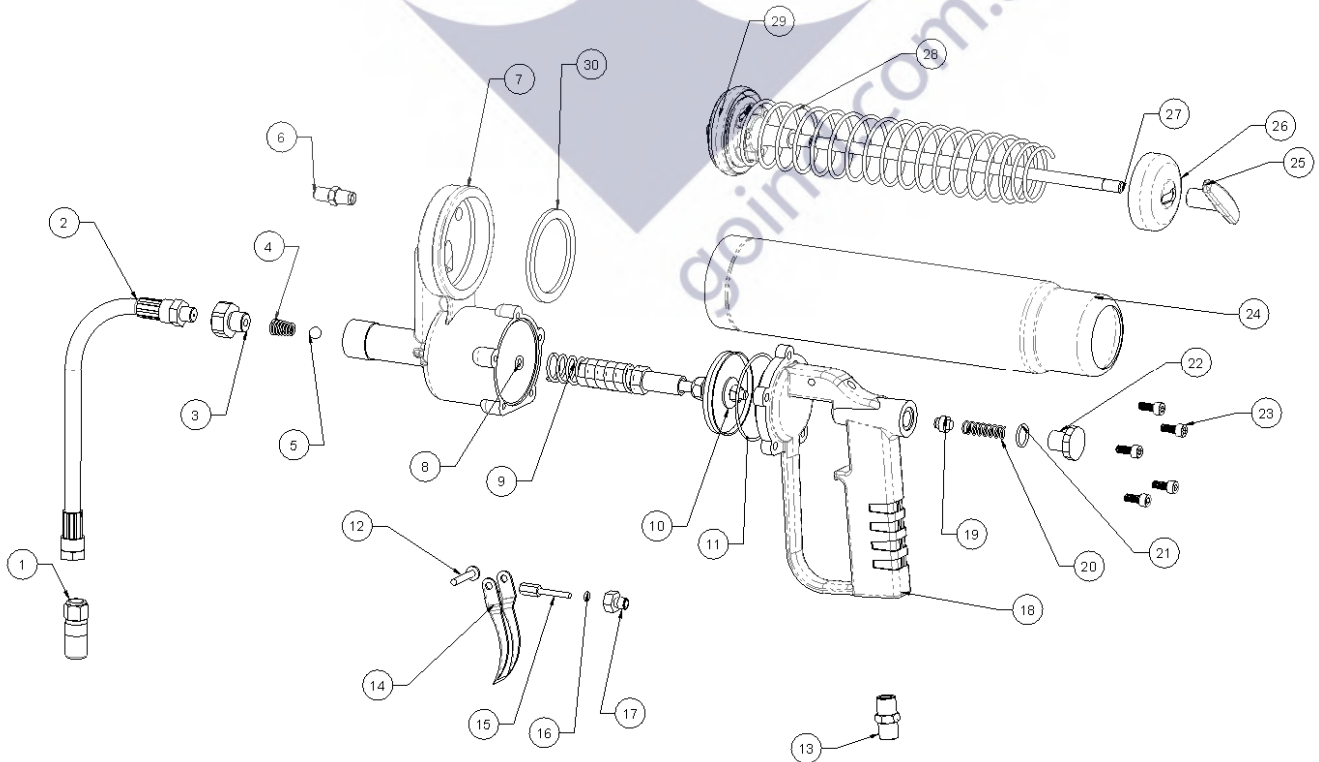

(Fig 6)

SPARE PARTS LIST

For easier model identification:

*Note:

Models manufactured before April 2003 were powder coated dark grey in colour.

Models manufactured after April 2003 are light grey in colour.

Item	K53 (450g) model		K54 (400g) model		Qty	Kit Ref	Part Name
	Order for replacement	Part or set	Order for replacement	Part or set			
	K53-1K		K53-1K			(KIT A)	OVERHAUL KIT
	K27-2K		KF14A-2K			(KIT B)	FOLLOWER KIT
1	KY		KY		1		COUPLER
2	KF9		KF9		1		FLEXIBLE EXTENTION
3					1	A	OUTLET VALVE BODY
4					1	A	OUTLET VALVE SPRING
5					1	A	STEEL BALL
6					1	A	FILLER BLEEDER ASSEMBLY
7	n/a - new gun required		n/a - new gun required		1		BODY CASTING
8					1	A	O'RING (BS010)
9					1	A	PISTON SPRING
10					1	A	PISTON ASSEMBLY
11					1	A	AIR MOTOR SEAL RING (BS035)
12					1	A	TRIGGER PIVOT SCREW
13					1	A	NIPPLE
14					1	A	TRIGGER
15					1	A	AIR VALVE STEM
16					1	A	O'RING (BS006)
17					1	A	GLAND NUT
18	n/a - new gun required		n/a - new gun required		1		HANDLE CASTING
19					1	A	AIR VALVE
20					1	A	AIR VALVE SPRING
21					1	A	O'RING (BS014)
22					1	A	RETAINER CAP
23					5		SOCKET HEAD CAP SCREW
24					1		BARREL
26					1		END CAP
30					1	B	SEAL WASHER
25	KF36	KF111s	KF35s	KF27s	1		PULL HANDLE
27					1		FOLLOWER ROD
28					1		FOLLOWER SPRING
29					1	B	FOLLOWER ASSEMBLY

Kit A - K53-1K

Kit B - K27-2K (K53 ONLY) or KF14A-2K (K54 ONLY)

TROUBLE SHOOTING GUIDE

TROUBLE	CAUSE	REMEDY
Gun fails to deliver grease.	a) Air trapped in the pressure chamber.	a) Disconnect Flexible hose assembly (2). Apply pressure to the pull handle (25), refer to Fig 6. Pull the trigger until grease starts flowing. Note: It may be necessary to remove the outlet body to release the air in the pressure chamber. When grease appears at the gun outlet ensure that the ball (5) and spring (4) is in place then replace the outlet body(3).
	b) Dirt under the outlet ball (5).	Clean ball and seat
Gun fails to deliver the correct grease pressure	a) Piston assembly (10) faulty. (check for escaping air through the vent holes in the body (7)).	Replace Piston assembly
	b) O'ring (16) damaged. (check for air escaping from under the trigger).	Replace with o'ring

TECHNICAL SPECIFICATIONS

Pressure Ratio	50:1
Air Supply Pressure Range	275kPa (40psi) to 825kPa (120psi)
Recommended Air Pressure	620 kPa (90psi)
Compressor Size	0.026 m ³ /min. (1 cfm or above)
Air Inlet Thread	¼" BSP.
Output per shot	1 cm ³ (approx)



Macnaught Pty Limited
ABN 66 000 075 785

41-49 Henderson Street
Turlella NSW 2205 Sydney Australia
Postal Address: PO Box 90
Arncliffe NSW 2205 Sydney Australia

T: +61 2 9567 0401
F: +61 2 9597 7773
W: www.macnaught.com.au

Note:

This product should be disposed of according to all applicable local and national government environment regulations and guidelines.



**For Warranty Terms and Conditions see macnaught.com.au
For a list of Australian Service Centres see macnaught.com.au**