



# Python<sup>®</sup> XL Series Pumps

Pneumatically Operated Pumps for Chemical Injection



PROVEN QUALITY. LEADING TECHNOLOGY.

# Python® XL Pneumatically Operated Pumps

## Features and Benefits

Python XL series pumps are ideal for wells with low gas pressure. Capable of operating up to 12,000 psi, the pumps are easy to operate and include an air motor with the same proven technology that Graco offers in other product lines. Plus the Python XL's extreme duty plungers (Chromex™ and ceramic coated), seals and air valves are designed for years of operation before replacement.

### Ease of serviceability

- Modular air valve design
- Removable pilot valve
- Pump lowers are interchangeable with other Python XL models
- Plunger packings can be replaced in 10 minutes or less

### Highest technology air motor on the market

- Only requires a minimum of 15 psi to operate pump
- Low air/gas consumption for increased efficiency
- Muffler provides low operation noise levels
- Proven Graco® Merkur® air motor technology

### Robust and simple design

- 316 SST fluid section/wetted parts
- Three stroke adjustment positions
- HNBR, FKM, FKM ETP, FFKM, and TFE/P plunger packings and check valve seals

### Environmentally friendly

- 97% recoverable exhaust gas
- Reduced fugitive methane emissions

#### Needle/Blow Off Valve

Helps control pump stroke speed and protects against over-pressure

#### Air Valve

Provides smooth and rapid changeover

#### Pump Stroke Adjustment

Three position stroke adjust

#### Adjustable Packing Seals

For better sealing and increased pump life

#### Pump Plunger Rod

Available in Chromex and ceramic coatings

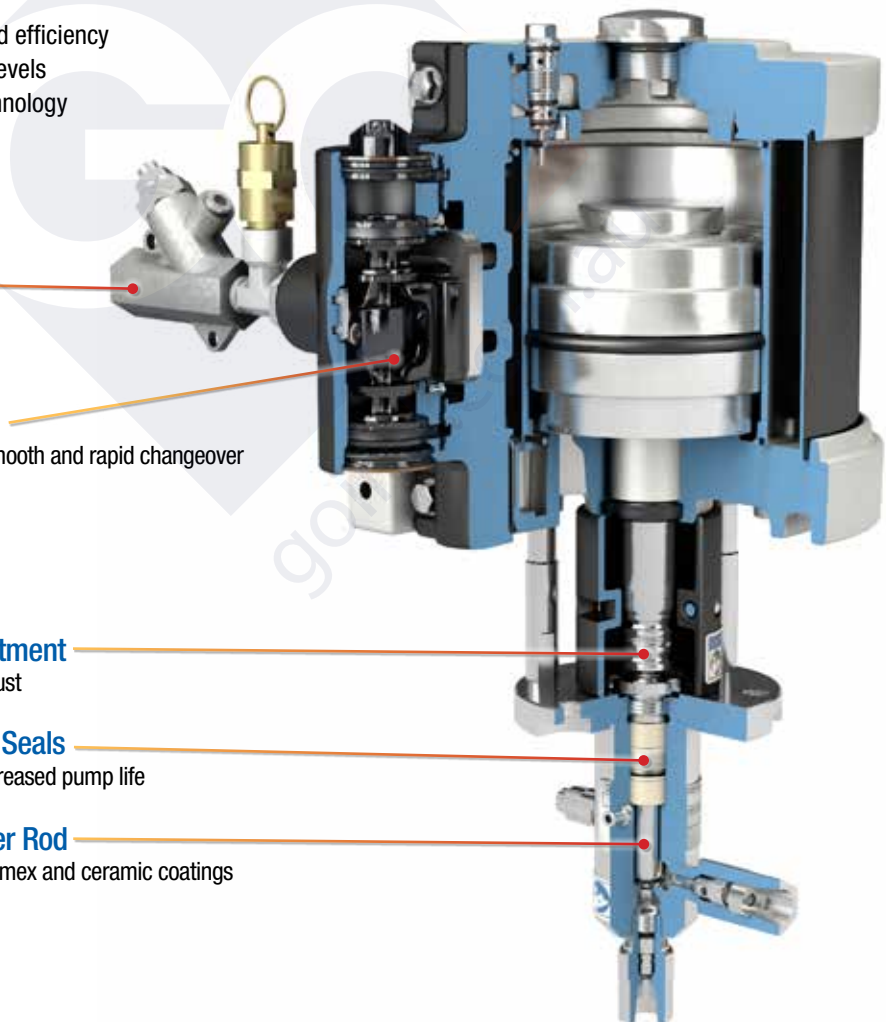

# Selecting the right flows at your given pressures to fit your chemical injection needs.

With three Merkur air motor sizes and up to six different plunger sizes to choose from, the performance table below helps you to quickly identify the right Python XL pump needed for your application.

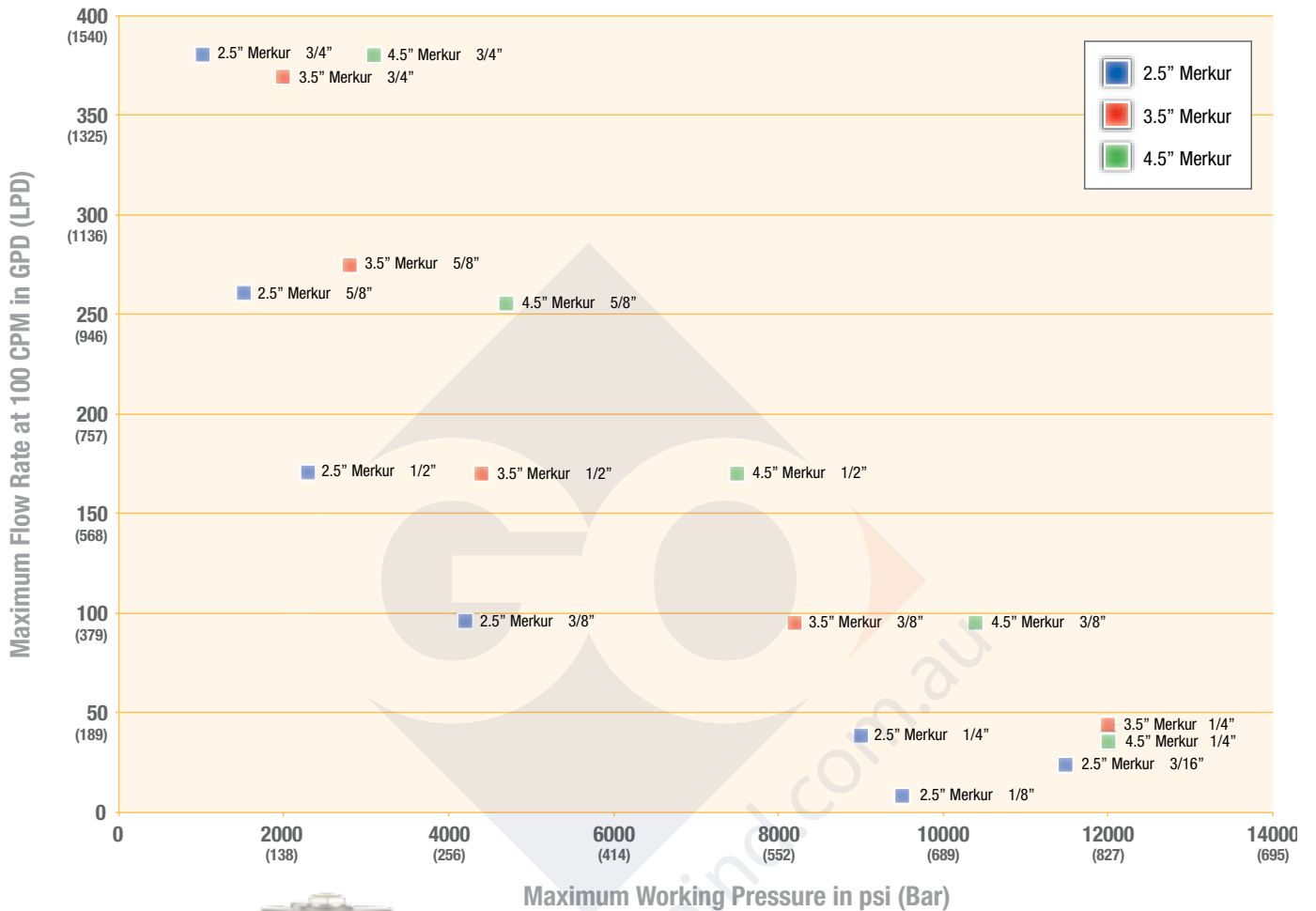

B32274  
Pump stand kit

# Ordering Information



| GRACO Python XL Pneumatic Pump Model Numbers 2.5"          |        |        |        |        |        |        |        |
|--|--------|--------|--------|--------|--------|--------|--------|
| Seals / Plunger Size                                       | 1/8"   | 3/16"  | 1/4"   | 3/8"   | 1/2"   | 5/8"   | 3/4"   |
| <b>Python XL, Chromex Coated Plungers (CE Certified)</b>   |        |        |        |        |        |        |        |
| FKM  | A25250 | A25255 | A25200 | A25201 | A25202 | A25203 | A25204 |
| FKM-ETP  | A25251 | A25256 | A25205 | A25206 | A25207 | A25208 | A25209 |
| HNBR   | A25252 | A25257 | A25210 | A25211 | A25212 | A25213 | A25214 |
| FFKM   | A25253 | A25258 | A25215 | A25216 | A25217 | A25218 | A25219 |
| TFE/P  | A25254 | A25259 | A25240 | A25241 | A25242 | A25243 | A25244 |
| <b>Python XL, Ceramic Coated Plungers (CE Certified)</b>   |        |        |        |        |        |        |        |
| FKM  | A25260 | A25265 | A25220 | A25221 | A25222 | A25223 | A25224 |
| FKM-ETP  | A25261 | A25266 | A25225 | A25226 | A25227 | A25228 | A25229 |
| HNBR   | A25262 | A25267 | A25230 | A25231 | A25232 | A25233 | A25234 |
| FFKM   | A25263 | A25268 | A25235 | A25236 | A25237 | A25238 | A25239 |
| TFE/P  | A25264 | A25269 | A25245 | A25246 | A25247 | A25248 | A25249 |
| <b>Python XL, Chromex Coated Plungers (ATEX Certified)</b> |        |        |        |        |        |        |        |
| FKM  | A25550 | A25555 | A25500 | A25501 | A25502 | A25503 | A25504 |
| FKM-ETP  | A25551 | A25556 | A25505 | A25506 | A25507 | A25508 | A25509 |
| HNBR   | A25552 | A25557 | A25510 | A25511 | A25512 | A25513 | A25514 |
| FFKM   | A25553 | A25558 | A25515 | A25516 | A25517 | A25518 | A25519 |
| TFE/P  | A25554 | A25559 | A25540 | A25541 | A25542 | A25543 | A25544 |
| <b>Python XL, Ceramic Coated Plungers (ATEX Certified)</b> |        |        |        |        |        |        |        |
| FKM  | A25560 | A25565 | A25520 | A25521 | A25522 | A25523 | A25524 |
| FKM-ETP  | A25561 | A25566 | A25525 | A25526 | A25527 | A25528 | A25529 |
| HNBR   | A25562 | A25567 | A25530 | A25531 | A25532 | A25533 | A25534 |
| FFKM   | A25563 | A25568 | A25535 | A25536 | A25537 | A25538 | A25539 |
| TFE/P  | A25564 | A25569 | A25545 | A25546 | A25547 | A25548 | A25549 |

| Common Pump Parts and Kits Ordering Information |   |         |                                    |
|---|---|---------|------------------------------------|
| Kit No.   | Item Description                        | Kit No. | Item Description                   |
| B32274  | Stand Leg Kit                           | B32191  | Priming Bleed Valve, low pressure  |
| B32272  | Wall Bracket 2.5", 3.5" Merkur          | B32250  | Priming Bleed Valve, high pressure |
| B32253  | Needle Valve Kit (110 psi safety valve) | B32273  | Air Motor Tie Rod                  |

For additional parts and kits, refer to Python XL instruction manual 3A3948, pages 36, 37, 38 and 43



B32302  
Pump Lower Kit  
1/2" Chromex Plunger



B32256  
1/2" Chromex Plunger



B32270  
Larger Adapter  
Plate Kit



B32264  
1/4" Packing Nut Kit



B32266  
1/2" Packing Nut Kit

## Key Points

- All pumps feature 1/4 in. npt(f) inlet connections.
- Kit B32240 can be used to convert an HF4 outlet connection to a 1/4 in. npt(f) for applications at or under 10,000 psi (689 bar).



| GRACO Python XL Pneumatic Pump Model Numbers 3.5"          |        |        |        |        |        |
|--|--------|--------|--------|--------|--------|
| Seals / Plunger Size                                       | 1/4"   | 3/8"   | 1/2"   | 5/8"   | 3/4"   |
| <b>Python XL, Chromex Coated Plungers (CE Certified)</b>   |        |        |        |        |        |
| FKM  | A25300 | A25301 | A25302 | A25303 | A25304 |
| FKM-ETP  | A25305 | A25306 | A25307 | A25308 | A25309 |
| HNBR   | A25310 | A25311 | A25312 | A25313 | A25314 |
| FFKM   | A25315 | A25316 | A25317 | A25318 | A25319 |
| TFE/P  | A25380 | A25381 | A25382 | A25383 | A25384 |
| <b>Python XL, Ceramic Coated Plungers (CE Certified)</b>   |        |        |        |        |        |
| FKM  | A25320 | A25321 | A25322 | A25323 | A25324 |
| FKM-ETP  | A25325 | A25326 | A25327 | A25328 | A25329 |
| HNBR   | A25330 | A25331 | A25332 | A25333 | A25334 |
| FFKM   | A25335 | A25336 | A25337 | A25338 | A25339 |
| TFE/P  | A25385 | A25386 | A25387 | A25388 | A25389 |
| <b>Python XL, Chromex Coated Plungers (ATEX Certified)</b> |        |        |        |        |        |
| FKM  | A25340 | A25341 | A25342 | A25343 | A25344 |
| FKM-ETP  | A25345 | A25346 | A25347 | A25348 | A25349 |
| HNBR   | A25350 | A25351 | A25352 | A25353 | A25354 |
| FFKM   | A25355 | A25356 | A25357 | A25358 | A25359 |
| TFE/P  | A25390 | A25391 | A25392 | A25393 | A25394 |
| <b>Python XL, Ceramic Coated Plungers (ATEX Certified)</b> |        |        |        |        |        |
| FKM  | A25360 | A25361 | A25362 | A25363 | A25364 |
| FKM-ETP  | A25365 | A25366 | A25367 | A25368 | A25369 |
| HNBR   | A25370 | A25371 | A25372 | A25373 | A25374 |
| FFKM   | A25375 | A25376 | A25377 | A25378 | A25379 |
| TFE/P  | A25395 | A25396 | A25397 | A25398 | A25399 |

| GRACO Python XL Pneumatic Pump Model Numbers 4.5"          |        |        |        |        |        |
|--|--------|--------|--------|--------|--------|
| Seals / Plunger Size                                       | 1/4"   | 3/8"   | 1/2"   | 5/8"   | 3/4"   |
| <b>Python XL, Chromex Coated Plungers (CE Certified)</b>   |        |        |        |        |        |
| FKM  | A25400 | A25401 | A25402 | A25403 | A25404 |
| FKM-ETP  | A25405 | A25406 | A25407 | A25408 | A25409 |
| HNBR   | A25410 | A25411 | A25412 | A25413 | A25414 |
| FFKM   | A25415 | A25416 | A25417 | A25418 | A25419 |
| TFE/P  | A25440 | A25441 | A25442 | A25443 | A25444 |
| <b>Python XL, Ceramic Coated Plungers (CE Certified)</b>   |        |        |        |        |        |
| FKM  | A25420 | A25421 | A25422 | A25423 | A25424 |
| FKM-ETP  | A25425 | A25426 | A25427 | A25428 | A25429 |
| HNBR   | A25430 | A25431 | A25432 | A25433 | A25434 |
| FFKM   | A25435 | A25436 | A25437 | A25438 | A25439 |
| TFE/P  | A25445 | A25446 | A25447 | A25448 | A25449 |
| <b>Python XL, Chromex Coated Plungers (ATEX Certified)</b> |        |        |        |        |        |
| FKM  | A25800 | A25801 | A25802 | A25803 | A25804 |
| FKM-ETP  | A25805 | A25806 | A25807 | A25808 | A25809 |
| HNBR   | A25810 | A25811 | A25812 | A25813 | A25814 |
| FFKM   | A25815 | A25816 | A25817 | A25818 | A25819 |
| TFE/P  | A25840 | A25841 | A25842 | A25843 | A25844 |
| <b>Python XL, Ceramic Coated Plungers (ATEX Certified)</b> |        |        |        |        |        |
| FKM  | A25820 | A25821 | A25822 | A25823 | A25824 |
| FKM-ETP  | A25825 | A25826 | A25827 | A25828 | A25829 |
| HNBR   | A25830 | A25831 | A25832 | A25833 | A25834 |
| FFKM   | A25835 | A25836 | A25837 | A25838 | A25839 |
| TFE/P  | A25845 | A25846 | A25847 | A25848 | A25849 |



# Technical Data

| Python XL Chemical Injection Pump  |  | US  | Metric      |
|--|--|---|-------------|
| Maximum pneumatic inlet pressure   |  | See Instruction Manual  |             |
| Maximum fluid working pressure   |  | See Instruction Manual  |             |
| Maximum cycle rate   |  | 100 cpm   |             |
| Environmental temperature range  |  | -40° – 176°F  | -40° – 80°C |
| <b>Noise (dBA)</b>   |  |   |             |
| 2.5 in. Air Motor Sound Power  |  | 83.2 dBA  |             |
| 2.5 in. Air Motor Sound Pressure   |  | 76.5 dBA  |             |
| 3.5 in. Air Motor Sound Power  |  | 84.5 dBA  |             |
| 3.5 in. Air Motor Sound Pressure   |  | 77.9 dBA  |             |
| 4.5 in. Air Motor Sound Power  |  | 80.1 dBA  |             |
| 4.5 in. Air Motor Sound Pressure   |  | 70.2 dBA  |             |
| <b>Inlet/Outlet Sizes</b>  |  |   |             |
| Fluid inlet size   |  | 1/4 in. npt(f)  |             |
| Fluid outlet size (3/8 in., 1/2 in., 5/8 in., and 3/4 in. plungers only) |  | 1/4 in. npt(f)  |             |
| Fluid outlet size (1/4 in. plungers only)                                |  | HIP HF4   |             |
| Prime/bleed size (3/8 in., 1/2 in., 5/8 in., and 3/4 in. plungers only)  |  | 10-32 UNF   |             |
| Prime/bleed size (1/4 in. plungers only)                                 |  | 1/16 in. npt(f)   |             |
| Pneumatic inlet size   |  | 1/4 in. npt(f)  |             |
| Exhaust fitting size   |  | 3/8 in. npt(f)  |             |
| <b>Materials of Construction</b>   |  |   |             |
| Pump/Check Valve Seal Material   |  | See Configuration Chart in manual for seal material. All other packing materials are PEEK and PTFE unless otherwise noted.  |             |
| Wetted Parts   |  | See Configuration Chart in manual for plunger material. All other materials are 316 stainless steel unless otherwise noted. |             |
| <b>Weight</b>  |  |   |             |
| 2.5 in. (ALL MODELS)   |  | 14.5 lbs.   | 6.6 kg      |
| 3.5 in. (ALL MODELS)   |  | 20.0 lbs.   | 9.1 kg      |
| 4.5 in. (ALL MODELS)   |  | 29.0 lbs.   | 13.2 kg     |

## Configuration Number Matrix

Check the identification plate (ID) for the 12-digit Configuration Number of your pump. Use the following matrix to define the components of your pump. *NOTE: Not all combinations are possible.*

Sample Configuration Number: **PCI-350-25S-XA-0**

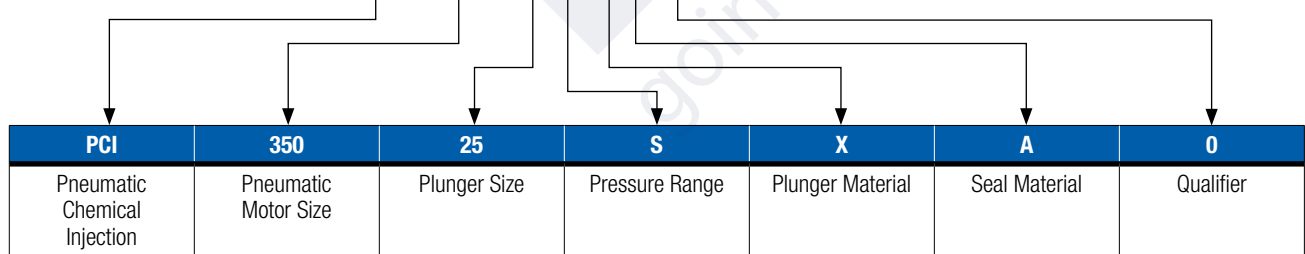

| Pneumatic Motor Size |        | Plunger Size (diameter) |       | Pressure Range |             | Plunger Material |         | Seal Material |        | Qualifier |      |
|----------------------|--------|-------------------------|-------|----------------|-------------|------------------|---------|---------------|--------|-----------|------|
| 250                  | 2-1/2" | 13                      | 1/8"  | S              | 1/4" NPT(F) | X                | Chromex | A             | FKM    | 0         | None |
| 350                  | 3-1/2" | 19                      | 3/16" | H              | HIP HF4     | C                | Ceramic | B             | FKMETP | A         | ATEX |
| 450                  | 4-1/2" | 25                      | 1/4"  |                |             |                  |         | C             | HNBR   |           |      |
|                      |        | 38                      | 3/8"  |                |             |                  |         | D             | FFKM   |           |      |
|                      |        | 50                      | 1/2"  |                |             |                  |         | E             | TFE/P  |           |      |
|                      |        | 63                      | 5/8"  |                |             |                  |         |               |        |           |      |
|                      |        | 75                      | 3/4"  |                |             |                  |         |               |        |           |      |



# Performance Curves

| KEY            |                     |
|----------------|---------------------|
| Inlet Pressure |                     |
| A              | = 15 psi (1.0 bar)  |
| B              | = 25 psi (1.7 bar)  |
| C              | = 50 psi (3.4 bar)  |
| D              | = 75 psi (5.2 bar)  |
| E              | = 100 psi (6.9 psi) |

**3/8" Plunger (PCI-250-38)**

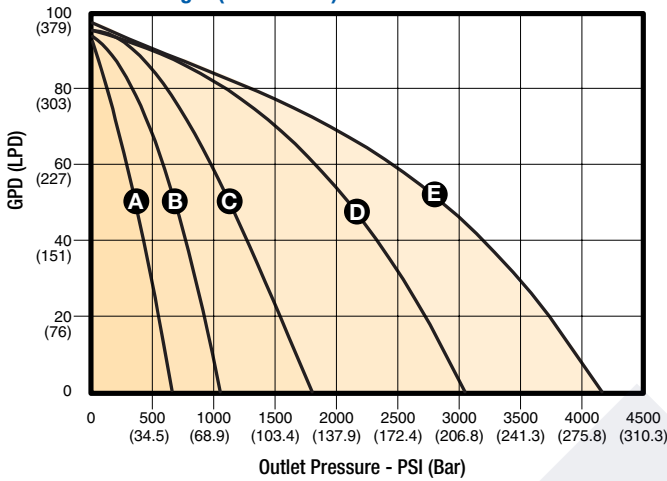

**1/2" Plunger (PCI-250-50)**

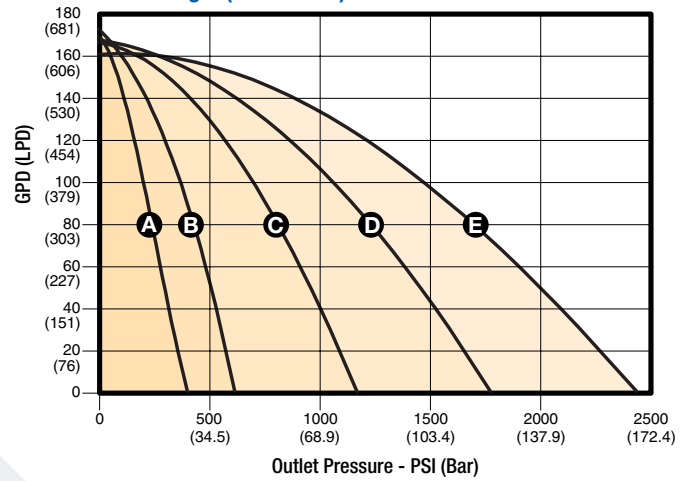

**5/8" Plunger (PCI-350-63)**

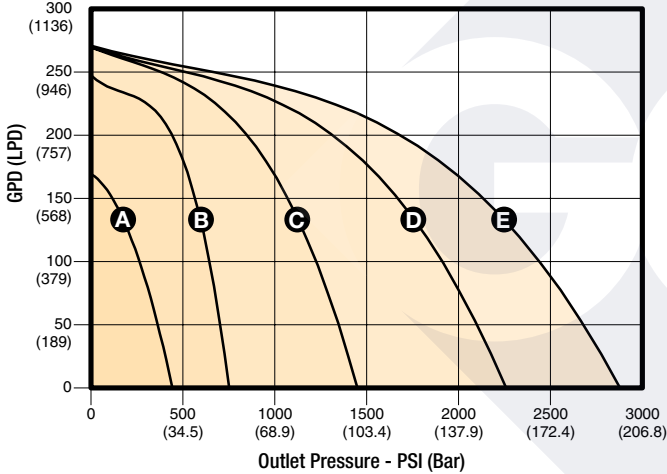

**3/4" Plunger (PCI-350-75)**

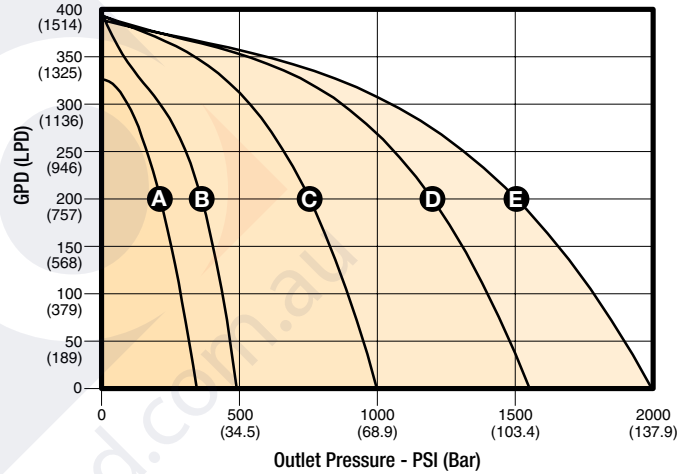

**5/8" Plunger (PCI-450-63)**

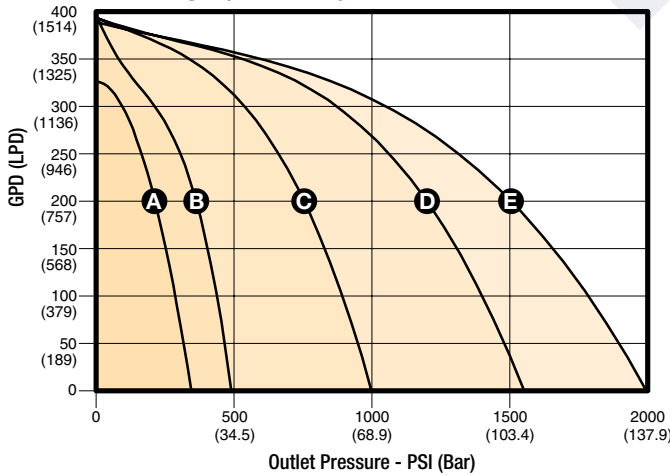

**3/4" Plunger (PCI-450-75)**

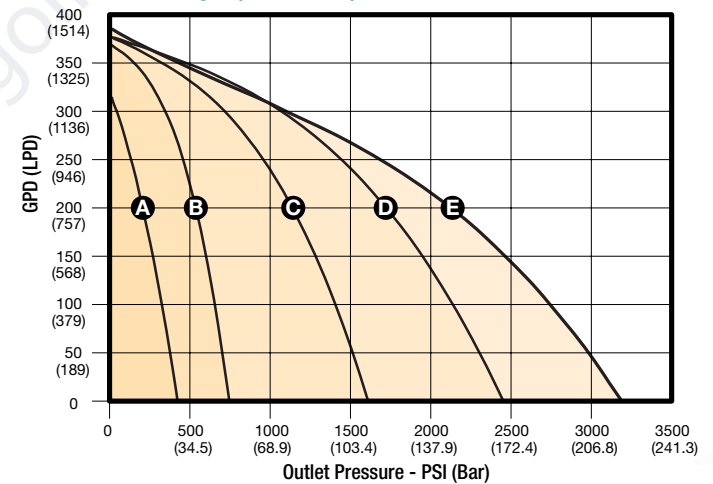

**Note:** performance charts for other plunger sizes are available in the instruction manual.



## ABOUT GRACO

### PROVEN QUALITY. LEADING TECHNOLOGY.

Founded in 1926, Graco is a world leader in fluid handling systems and components. Graco products move, measure, control, dispense and apply a wide range of fluids and viscous materials used in vehicle lubrication, commercial and industrial settings.

The company's success is based on its unwavering commitment to technical excellence, world-class manufacturing and unparalleled customer service. Working closely with qualified distributors, Graco offers systems, products and technology that set the quality standard in a wide range of fluid handling solutions. Graco provides equipment for spray finishing, protective coating, paint circulation, lubrication, and dispensing sealants and adhesives, along with power application equipment for the contractor industry. Graco's ongoing investment in fluid management and control will continue to provide innovative solutions to a diverse global market.

## GRACO LOCATIONS

### MAILING ADDRESS

P.O. Box 1441  
Minneapolis, MN 55440-1441  
Tel: 612-623-6000  
Fax: 612-623-6777

### AMERICAS

#### MINNESOTA

Worldwide Headquarters  
Graco Inc.  
88-11th Avenue N.E.  
Minneapolis, MN 55413

### EUROPE

#### BELGIUM

European Headquarters  
Graco BVBA  
Industrieterrein-Oude Bunders  
Slakweidestraat 31  
3630 Maasmechelen,  
Belgium  
Tel: 32 89 770 700  
Fax: 32 89 770 777

### ASIA PACIFIC

#### AUSTRALIA

Graco Australia Pty Ltd.  
Suite 17, 2 Enterprise Drive  
Bundoora, Victoria 3083  
Australia  
Tel: 61 3 9467 8558  
Fax: 61 3 9467 8559

#### CHINA

Graco Fluid Equipment Co, Ltd  
Shanghai Representative Office  
Building 7  
1029 Zhongshan Road South  
Huangpu District  
Shanghai 200011  
The People's Republic of China  
Tel: 86 21 649 50088  
Fax: 86 21 649 50077

#### INDIA

Graco India Pvt Ltd  
Plot No 295, Udyog Vihar Phase-IV  
Gurugram - 122015 (Haryana)  
India 122001  
Tel: 91 124 6610200  
Fax: 91 124 6610201

#### JAPAN

Graco K.K.  
1-27-12 Hayabuchi  
Tsuzuki-ku  
Yokohama City, Japan 2240025  
Tel: 81 45 593 7300  
Fax: 81 45 593 7301

#### KOREA

Graco Korea Inc.  
38, Samsung 1-ro 1-gil  
Hwaseong-si, Gyeonggi-do,  
18449  
Republic of Korea  
Tel: 82 31 8015 0961  
Fax: 82 31 613 9801

## SALES/ DISTRIBUTION/ SERVICE

Call today for product information or to request a demonstration.

**866-552-1868** or visit us at [www.graco.com/ong](http://www.graco.com/ong)

Graco Inc. is registered to I.S. EN ISO 9001

North America  
Customer Service  
866-552-1868  
Fax 877-340-6427