

# RUPES®



## S130/S230 L / PL / EL / EPL / EM / EPM

## S145/S245 L / PL / EL / EPL / EM / EPM

- 4 - **Unità mobili di servizio**
- 8 - **Mobile service stations**
- 12 - **Stations auxiliaires mobiles**
- 16 - **Mobile Energie-Wagen**
- 20 - **Estaciones de servicio móviles**
- 24 - **Equipamento de aspiração móvel**
- 28 - **Verrijdbare servicestations**
- 32 - **Liikuteltava teollisuusimuri**
- 36 - **Mobil servicestation**
- 40 - **Mobil servicestation**
- 44 - **Мобильная установка пылеудаления**
- 48 - **Mobilna stacja serwisowa**
- 52 - **Κινητός σταθμός σέρβις**
- 56 - **Подвижна прахосмукачка**
- 60 - **Mobilní servisní stanice**
- 64 - **Liikuv hooldusjaam**
- 68 - **मोबाइल सेवा शन**
- 72 - **Mobil szolgáltatóállomás**
- 76 - **Mobilais rūpnieciskais putekļsūcējs**
- 80 - **Mobili aptarnavimo stotelė**
- 84 - **Stație deservire mobilă**
- 88 - **Mobilná servisná stanica**
- 92 - **Mobilna servisna postaja**
- 96 - **Mobil servis istasyonu**
- 100 - **محطة خدمة متنقلة**
- 104 - **移动服务站**

*ISTRUZIONI ORIGINALI PER L'USO*

*ORIGINAL OPERATING INSTRUCTIONS*

*TRADUCTION DES INSTRUCTIONS DE FONCTIONNEMENT ORIGINALES*

*ÜBERSETZUNG DES ORIGINALBETRIEBSANLEITUNG*

*TRADUCCIÓN DEL MANUAL DE INSTRUCCIONES ORIGINAL*

*TRADUÇÃO DAS INSTRUÇÕES DE OPERAÇÃO ORIGINAIS*

*VERTALING VAN ORIGINELE GEBRUIKSAANWIJZING*

*ALKUPERÄISTEN KÄYTTÖOHJEIDEN KÄÄNNÖS*

*OVERSÆTTELSE AF ORIGINALE BETJENINGSINSTRUKTIONER*

*ÖVERSÄTTNING AV ORIGINAL DRIFTSINSTRUKTIONER*

*ПЕРЕВОД ОРИГИНАЛЬНОЙ ИНСТРУКЦИИ ПО ЭКСПЛУАТАЦИИ*

*TŁUMACZENIE ORYGINALNYCH INSTRUKCJI OBSŁUGI*

*ΜΕΤΑΦΡΑΣΗ ΠΡΩΤΟΤΥΠΩΝ ΟΔΗΓΙΩΝ ΛΕΙΤΟΥΡΓΙΑΣ*

*ПРЕВОД НА ОРИГИНАЛНИ ИНСТРУКЦИИ ЗА ЕКСПЛОАТАЦИЯ*

*PŘEKLAD ORIGINÁLNÍHO NÁVODU K OBSLUZE*

*ORIGINAALKASUTUSJUHENDI TÕLGE*

*इस्तेमाल के लिए मूल नरिदेशों का अनुवाद*

*AZ EREDETI HASZNÁLATI UTASÍTÁS FORDÍTÁSA*

*ORIGINĀLĀS LIETOŠANAS INSTRUKCIJAS TULKOJUMS*

*ORIGINALŲ NAUDOJIMO INSTRUKCIJŲ VERTIMAS*

*TRADUCEREA INSTRUCȚIUNILOR ORIGINALE DE OPERARE*

*PREVOD IZVIRNIH NAVODIL ZA DELOVANJE*

*PREKLAD ORIGINÁLNEHO NÁVODU NA OBSLUHU*

*ORIJINAL KULLANIM TALİMATLARININ TERCÜMESİ*

*تفصيلاً لى غثتلا تاميل عت تم جرت*

*操作说明书原件翻译*

S230/245

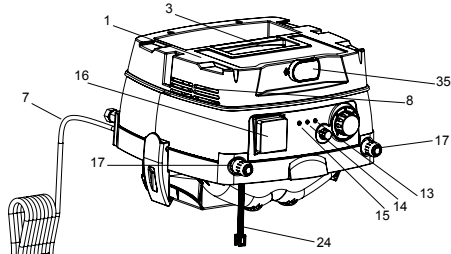

S130/145

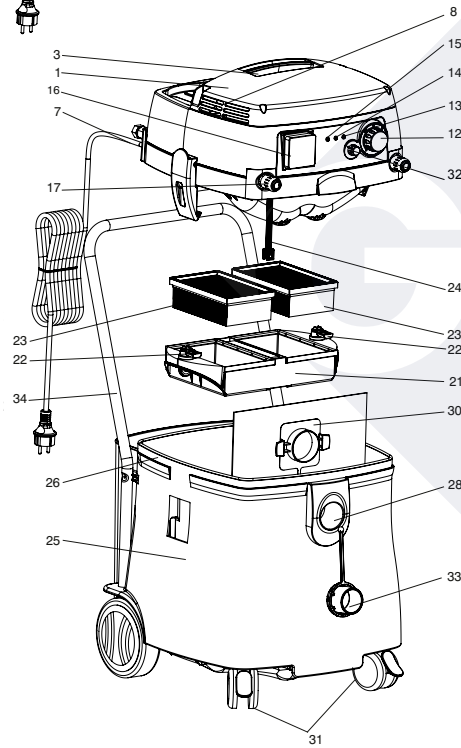

1

30 lt

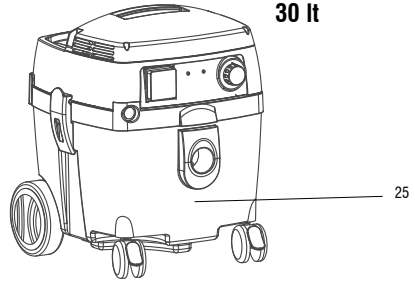

45 lt

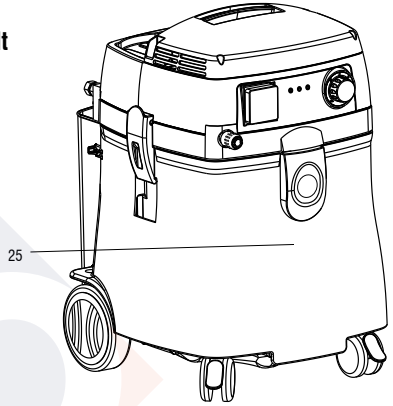

2

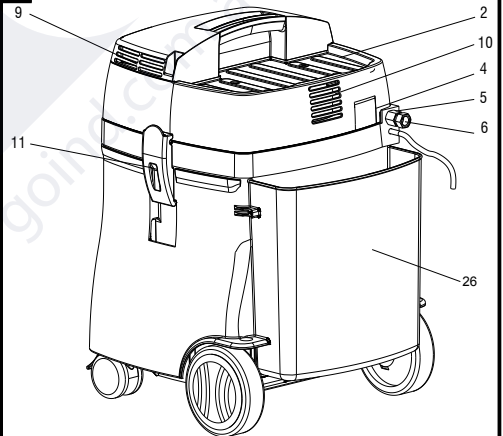

3

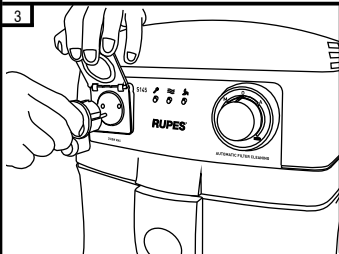

4

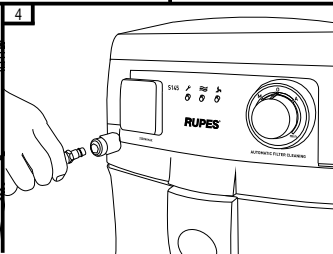

5

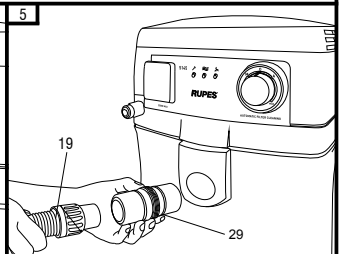

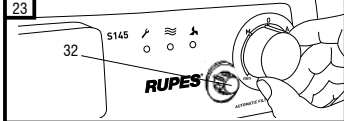
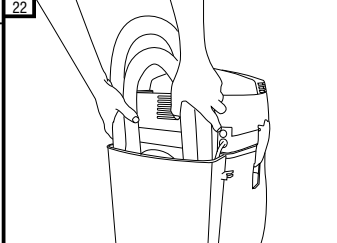
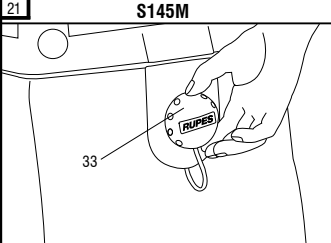
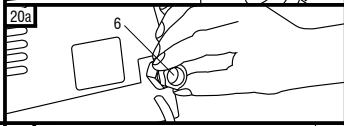
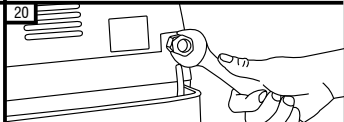
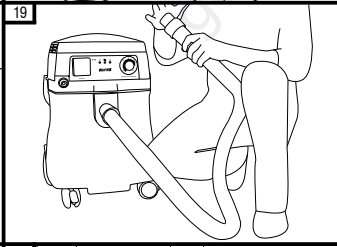
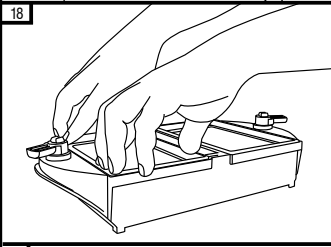
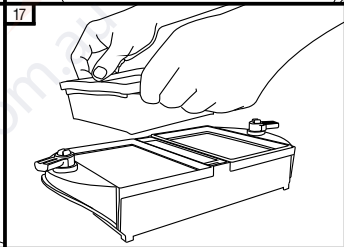
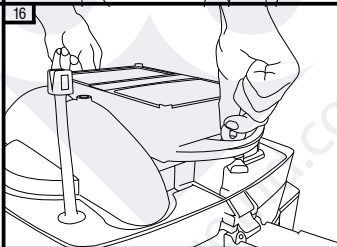
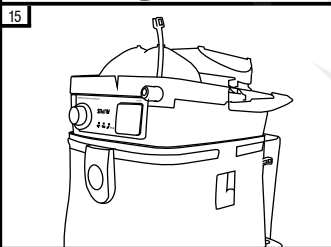
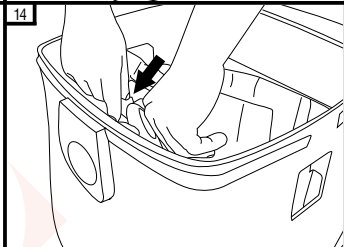
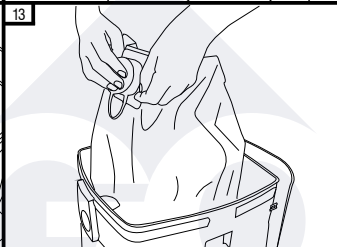
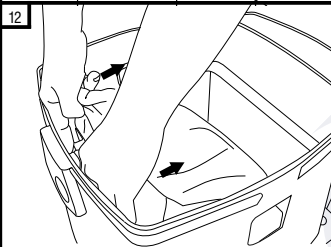
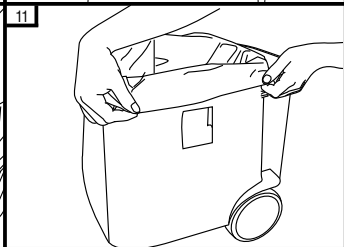
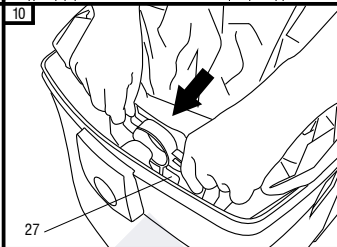
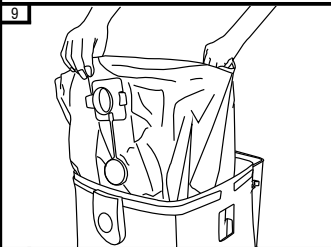
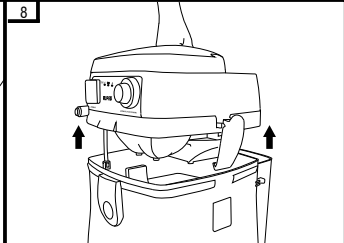
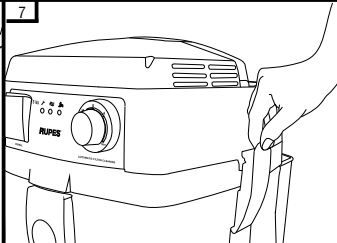
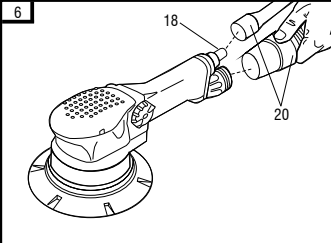
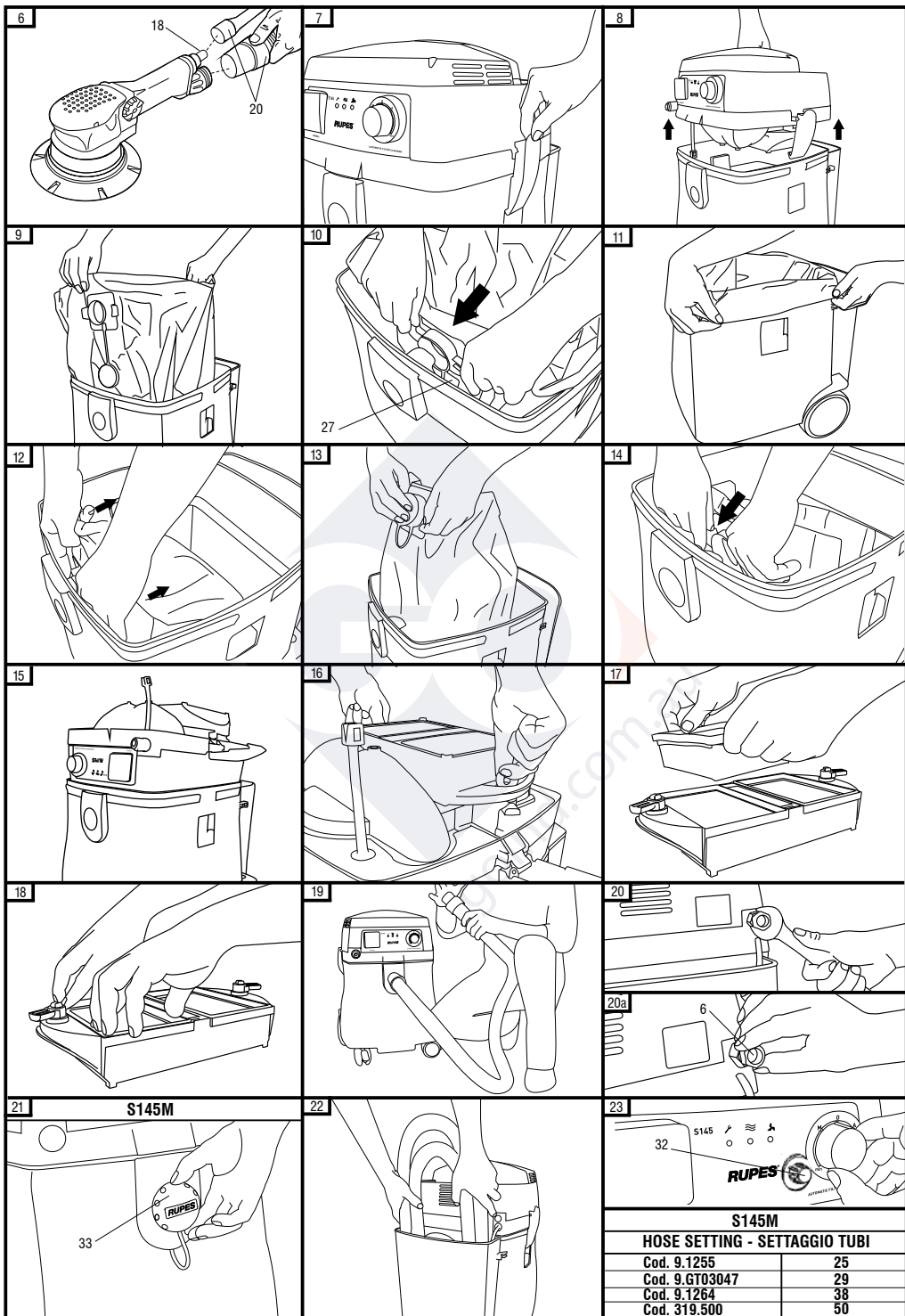

S145M	
HOSE SETTING - SETTAGGIO TUBI	
Cod. 9.1255	25
Cod. 9.GT03047	29
Cod. 9.1264	38
Cod. 319.500	50

## PICTOGRAPH



Read the following instruction first before operating the product



Important safety indications



**Caution!** This appliance contains dust hazardous to health. Emptying and maintenance operations, **including removal of the dust collection means**, must only be carried out by authorized personnel wearing suitable personal protections. Do not operate without the full filtration system fitted.

## Symbol key:

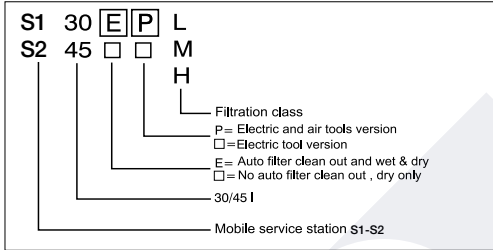

	S130L-ELEM	S130PL-EPL-EPM	S230L-ELEM	S230PL-EPL-EPM
N°1 DUST BAG (30)	X	X	X	X
N°1 SWIVELLING NOZZLE	X	X	X	X
N°2 FRONT WHEELS	X	X	X	X
N°2 RUBBER HOSE CUFFS	X	X	X	X
N°1 REAR WHEEL AXLE (30 I VERSION)	X	X	X	X
HOSE 1X5 M	X		X	

	S145L-ELEM	S145PL-EPL-EPM	S245L-ELEM	S245L-EPL	S245EPM
N°1 DUST BAG (30)	X	X	X	X	X
N°1 SWIVELLING NOZZLE	X	X	X	Y VARY (COD. 67.092/C)	X
N°2 FRONT WHEELS	X	X	X	X	X
N°2 RUBBER HOSE CUFFS	X	X	X		
HOSE 1X5 M	X	X	X		
SOFTGRIP HANDLE			X	X	X



For packaging waste disposal attain to local regulations in force, including recycling disposal if requested.

## SAFETY INFORMATION FOR VACUUM CLEANERS

### Safety and accident prevention instructions

- **children being supervised** not to play with the appliance;
- This machine can only be operated by trained people in charge; machine not intended to be operated by kids or mental-sensorial defective people;
- before use, users should be provided with information, instruction and training for the use of the appliance and the pollutant it is used for, including the right method for the safe removal and disposal of the substances collected;
- it is necessary to provide an adequate air change rate in the room if the exhaust air is returned in the room. Reference to National Regulations is necessary;
- the temperature of the work area must be between 10°C and 35°C with humidity between 50% and 90%;
- the surface on which the machine rests must not exceed a maximum 10 degree gradient;
- always unplug the machine when not in use, before maintenance or cleaning, and before replacing the dust bag or filters;
- do not pull the power cord to unplug the machine;
- keep the power cord away from heat, oil and sharp edges;
- in the event of a blackout, turn the tool switch in OFF position to avoid accidental start when power come back;
- do not expose the machine to rain and low temperatures;
- do not lift and transport the machine by the handle with a lifting device;
- wet filters and the interior part of the liquid container are dried before storage.



## Explosion or fire hazard

- Do not vacuum flammable or explosive dust (i.e. magnesium, aluminium, etc.);
- do not vacuum sanding dust from surfaces treated with paints that have not completed the catalyst cycle;
- do not vacuum sparks or white hot shavings;
- immediately disconnect the vacuum from the electrical mains if dust is ejected from air outlet;
- do not vacuum flammable or explosive liquids (i.e. petrol, thinners, etc.);
- do not vacuum aggressive liquids or substances (i.e. acids , bases, solvents, etc.);
- **VERSION "E"**: immediately disconnect the machine from the power supply if you notice the presence of foam or liquid leaking during the vacuuming of liquid.

## SPECIFIC USE



- **CAUTION** This machine is for indoor use only
- **CAUTION** This machine shall be stored indoors only  
Only for models series L/PL:
- **WARNING** This machine is for dry use only

- This appliance is suitable for heavy duty and industrial operations in accordance with EN60335-1 e EN60335-2-69;
- this appliance is suitable for commercial use: i.e. hotels, school, hospitals, factories, shops, offices and rental business.
- the front power socket is only intended for specific use as indicated in the present instruction manual.
- VERSION "E": this appliance is suitable for liquids suction;

## VERSION "L":

Appliance suitable for separating dust with a limit value of occupational exposure of  $\geq 1 \text{ mg/m}^3$ .  
(Class L – Light HAZARD).



## VERSION "M":

Appliance suitable for separating dust with a limit value of occupational exposure of  $\geq 0,1 \text{ mg/m}^3$  and wood dust.  
(Class M – Medium HAZARD).



Refer to all regulations applicable to the substances and pollutant collected.



- **WARNING:** for class M vacuum cleaners the outside of the machine must be decontaminated with vacuum cleaning methods and cleaned or treated with sealant before being taken from a hazardous area

## TECHNICAL SPECIFICATIONS SERIE S1/S2

OPERATING VOLTAGE AND FREQUENCY	230 Vac - 50/60 Hz JP 100 Vac - 50/60Hz
POWER	1200 W JP 1050 W (@min.500 W)
POWER AT SOCKET (MAX)	EU 2400 W UK 1800 W CH-DK 1100 W AUS 1200 W JP 380 W (@min.930 W) UK (110V) 1100 W
TOTAL POWER (MAX)	EU 3600 W UK 3000 W CH-DK 2300 W AUS 2400 W JP 1430 W UK (110V) 2150 W
AIR CAPACITY EN 60335-2-69	250 m <sup>3</sup> /h
VACUUM LEVEL	215 hPa
WEIGHT	10,2 kg (S130-S230) 13,5 kg (S145-S245)
DIMENSIONS	cm 43 x 42,5 x h 51 (S130-S230) cm 47 x 45 x h 63,5 (S145-S245)
CLASS OF PROTECTION	IP X 4
NOISE LEVEL ISO 3744	70 dB(A) - 73 dB (A) VERSION "E"
FILTERS SURFACES	2 x 0,50 m <sup>2</sup>
CAPACITY OF DUST COLLECTION BAG	kg 5 max
CONTAINER CAPACITY	30 l (S130-S230) 45 l (S145-S245)
POWER CONTROL SWITCH	MAN - 0 - AUT
PNEUMATIC SECTION	VERSION "P"
INLET AIR PRESSURE	6 bar
MAX COMPRESSED AIR FLOW	1450 l/min
INLET FITTING	3/8" G female

## PARTS OF THE TOOL

- 1 - Vacuum head
- 2 - Tool tray
- 3 - Handle
- 4 - Identification plate
- 5 - Compressed air inlet (VERSION "P")
- 6 - Air coupling filter (VERSION "P")
- 7 - Power cord
- 8 - Cooling air inlet
- 9 - Cooling air outlet
- 10 - Operating air outlet
- 11 - Head lockers
- 12 - Man-0-Aut switch with speed control
- 13 - Motor ON indicator
- 14 - Liquid level indicator (VERSION "E")
- 15 - Service indicator
- 16 - Electric tool socket
- 17 - Quick coupling for pneumatic tool (VERSION "P")
- 18 - Pneumatic tool connection
- 19 - Electric tool hose
- 20 - Pneumatic tool hose (optional)
- 21 - Filter frame
- 22 - Filter frames lockers
- 23 - Filters (paper or polyester)
- 24 - Liquid level sensor (VERSION "E")
- 25 - Dust bin
- 26 - Accessories compartment (VERSION 45 l)
- 27 - Antistatic connection
- 28 - Hose nozzle
- 29 - Universal swivelling nozzle
- 30 - Dust collection bag (paper or plastic)
- 31 - Castor wheels with lock
- 32 - Suction hose setting (VERSION "M")
- 33 - Rubber cap (VERSION "M")
- 34 - Softgrip handle
- 35 - Swivel block for fixing case

## START-UP

### Power supply

- Turn the main switch (12) to "0" (off) before connecting this appliance to the supply mains;
- supply mains voltage and frequency must match the identification plate;
- connect to power socket outlets provided with earth conductor and adequate protections.

### Compressed air mains

- Do not exceed 6 bar;
- dehumidified and filtered air required;
- connect the appliance to the compressed air main with an hose suitable for the air pressure and int. diam. 10 mm min.

### Assembling the swivelling adaptor (29)

Insert the adaptor in the inlet nozzle (28).

### Electrical tool connections

- Check for the tool switch turned off before connecting it to the front panel socket outlet;
- insert the tool plug into the front panel socket (16) (pic. 3);
- connect the tool to the swivelling nozzle with the hose (19) (pic. 5);
- do not plug electric tools exceeding the power indicated on the front panel.

### Pneumatic tool connections

- Check for the tool switch turned off before connecting it to the front panel quick coupling;
- connect the tool to the appliance with the quick couplings (17) (pic. 4) and (18) (pic. 6);
- connect the coaxial hose (optional) to the quick coupling (20) (pic.6).

Check the tool functioning as indicated on their instructions manual.

### Preliminary checks

- Check that the dust collection bag (30) has been fitted in the container (25) and that the filters (23) have been fitted on the head;
- check that the vacuum hose is properly fixed and does not hinder tool movement;
- check that there are no leaks in the compressed air supply system.

## MACHINE USE

The machine can operate in manual or automatic mode: to select the mode, turn the switch (12) to the right (automatic mode) or to the left (manual mode) (pic. 23). The green indicator (13) turns on when the vacuum motor starts.

### Using the machine in automatic mode (A)

Automatic operations means that the vacuum starts when an electrical or pneumatic tool is turned on.

The vacuum will automatically turn off eight seconds after the tool is turned off.

### Using the machine in manual mode (M)

Manual operations means that the vacuum runs continuously.

Power on the front panel outlet socket is permanently active during manual running.

### Adjusting the vacuum level

The vacuum level can be adjusted in both operating modes by turning the knob (12) towards the "min" position until the desired power is reached.

### Automatic cleaning of the filters (VERSION "E")

The machine has a timed filter cleaning system that maintains the vacuum strength constant.

**It is also possible to perform a complete cleaning cycle as follows (pic. 19):**

- switch the machine off;
- cap the vacuum sleeve;
- restart the machine keeping the sleeve capped for 15 seconds.

### Suction hose setting (VERSION "M")

For operators safety the appliance for M class dust are provided with an indicator which operates in case of the air velocity through the hose falling below 20 m/sec. Check the hose diameter and set the correct value on the front panel throttle (32) (pic. 23).



To be used with genuine RUPES hoses.

### Acoustic alarm operates (VERSION "M")

In case of acoustic alarm on locate the causes (C.) and redress (R.) it with the action recommended in the following procedure:

- C: Power set-up too low;  
*R: Increase the suction power;*
- C: The hose diameter doesn't match with the hose set-up on the front panel;  
*R: Set the hose diameter knob (32) on the right diameter;*
- C: Clogged or bended hose;  
*R: Check and set straight the hose;*
- C: Dust bag full;  
*R: See dust bag "REPLACEMENT SECTION";*
- C: Clogged filters;  
*R: See filter cartridges "REPLACEMENT SECTION".*



After operating in hazardous dust contaminated environment all appliance parts must be considered as contaminated; before handling the appliance out the contaminated area or servicing it, remove all the dust from it with vacuum or cloth, seal the dust container with the rubber cap (33), and store hose and accessories in a sealed bag (VERSION "M").

### Wet vacuum (VERSION "E")

Before vacuuming liquids, remove the dust bag (paper or plastic) and replace the paper filters cartridges with polyester ones. The filters should be damp after vacuuming.

Do not operate with dry dust with wet filters!

### Liquid level indicator (VERSION "E")

The vacuum motor stops and the liquid level indicator (14) turns on when the liquid sensor (24) detects the bin (25) full. To reset empty the bin (25).

## MAINTENANCE



A yearly technical check on parts and filtering system by an authorized service centre is required.

### Service indicator (15)

The indicator turns on for scheduled service to keep the machine working conditions. When warning light is on contact an authorized service centre to check and service the appliance and reset the warning light.

The prolonged use of the vacuum cleaner with the warning light on can cause more maintenance operation.

### Ordinary check operations



For user servicing, the appliance must be dismantled, cleaned and serviced, as far as it is reasonably practicable, without causing risk to the maintenance staff and others. Suitable precautions include, decontamination before dismantling, provision for local filtered exhaust ventilation where the appliance is dismantled (according to local regulations), cleaning of the maintenance area and suitable personal protection.

- check the vacuum hose conditions;
- **VERSION "E"**: clean the liquid level sensor (24);
- check the power cord, plug and outlet socket conditions: in case contact an authorized service centre for replacement;
- check the dust bag: do not exceed recommended weight and capacity! In case of laceration or perforation of the dust bag check the filter cartridge and eventually ask for replacement to an authorized service centre;
- check filter cartridges condition (23). In case of lacerations or perforations contact an authorized service centre for replacement.



Do not use the appliance without the full filter set fitted!

### Bag replacement



Do not spread dust during dust bag replacement!

- wear an adequate dust mask;
- detach the vacuum head pushing the side hooks (11) and remove the vacuum head (1) (pic. 7-8).

### Paper bag (cod. 042.1108/5):

- **VERSION "M"**: seal the dust container with the appropriate cap (33);
- remove the full bag closing the nozzle with the cap provided (pic. 12 and 13);
- put the new bag inserting the nozzle as illustrated (pic. 14).

### Plastic bag:

- remove the full plastic bag (pic. 9);
- place the new bag, verifying that the nozzle is positioned on the inlet (pic. 10);
- turn the bag edge as shown (pic. 11); make sure to keep the compensation holes inside the bin.



Only use genuine RUPES dust bags.  
Spare bags should be kept in dry places!  
Follow local legal regulations for disposal.

## Filter replacement



Do not spread dust during filter replacement!

- Wear adequate filter mask;
- **VERSION "M"**: seal the dust container with the appropriate cap (33);
- detach the vacuum head pushing the side hooks (11) (pic.7-8);
- turn the vacuum head upside down (pic.15);
- remove the filter frame (21) turning the hooks (22) (pic. 16);
- remove the filter cartridges (pic. 17) and fit them into a sealed disposal bag;
- fit new filter (cod. 036.1108) cartridges in the filter frame (pic.18) and reassemble it on the vacuum head.



Use genuine RUPES spare parts only.  
Refer to [www.rupes.com](http://www.rupes.com) for parts code and authorized service centre

RUPES will not be held responsible for direct or indirect damages resulting from non-compliance with the requirements of this manual.

## TOOL IDENTIFICATION PLATE

POSITION AND MEANING OF INFORMATION

1. Type of tool.
  2. Nominal working voltage Volts (V).
  3. Working frequency Hertz (Hz).
  4. Class of protection.
  5. Absorbed power Watt (W).
  6. Power at socket (MAX) Watt (W).
  7. Power max Watt (W).
  8. Serial number.
9. Read all this instructions before operating this product and save these instructions.

## 10. DISPOSAL (WEEE DIRECTIVE)



**For EU countries only:** According to the European Directive on Waste from electrical and electronic equipment and its implementation in conformity with national standards, exhausted electrical equipment must be collected separately, in order to be recycled in an environmentally friendly way. The product, when it reaches the end of its life, must not be dispersed in the environment or thrown away as household waste. It must be disposed at authorized recycling centres (contact your local authorities to know where to dispose of the product according to the law). The correct disposal of the product contributes to the health and preservation of the environment. Illegal disposal of the product will entail penalties against the offenders.

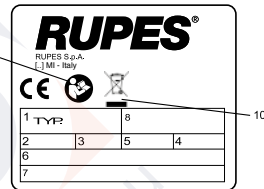

## TROUBLESHOOTING AND SOLUTION

Effects	Causes	Solutions
The motor will not start	No power	Make sure the unit is plugged in
	Power cord, switch or motor defective	Contact an authorised service centre
The vacuum does not start automatically	Electronic module	Contact an authorised service centre
Vacuum flow is insufficient	Bag full	Check the filter bag
	One of the hoses or accessories is clogged	Check the flexible hose and the accessories
	Clogged filters	Check the filters cartridges
Dust from the exhaust (10)	Filter cartridge torn ripped	Contact an authorised service centre
Tools do not start	3-way switch malfunction	Contact an authorised service centre
Insufficient Power for pneumatic tool	Insufficient compressed air feeding	Check air passage
Red indicator on	Ordinary maintenance limit exceeded	Contact an authorised service centre
Yellow indicator on (VERSION "E")	Max. liquid level exceeded	Empty the bin



RUPES S.p.A. a socio unico

Via Marconi, 3/A - Loc. Vermezzo  
20071 VERMEZZO CON ZELO (MI) - Italy  
Tel. 02/946941  
Fax 02/94941040

Uff. Vendite e assistenza clienti  
Tel. 02/94694312

e-mail: [info\\_rupes@rupes.it](mailto:info_rupes@rupes.it)  
web: <http://www.rupes.com>

Sede legale:  
Viale Bianca Maria, 13 - 20122 MILANO - ITALY